

# Coupled Natural Gas and Electric Power Systems

by

Tommy Leung

B.S. Engineering, Harvey Mudd College (2005)  
S.M., Massachusetts Institute of Technology (2012)

Submitted to the Engineering Systems Division  
in partial fulfillment of the requirements for the degree of

DOCTOR OF PHILOSOPHY

at the

MASSACHUSETTS INSTITUTE OF TECHNOLOGY

June 2015

© Massachusetts Institute of Technology 2015. All rights reserved.

Author .....  
Engineering Systems Division  
May 1, 2015

Certified by .....  
Joseph Sussman  
Committee Chair  
Professor of Civil Engineering and Engineering Systems

Certified by .....  
Ignacio J. Pérez Arriaga  
Thesis Supervisor  
Visiting Professor of Engineering Systems

Certified by .....  
Ernest J. Moniz  
Cecil and Ida Green Professor of Physics and Engineering Systems

Certified by .....  
Mort Webster  
Associate Professor of Engineering Systems

Accepted by .....  
Munther Dahleh  
William A. Coolidge Professor of Electrical Engineering and Computer Science  
Acting Director, Engineering Systems Division



# Coupled Natural Gas and Electric Power Systems

by

Tommy Leung

Submitted to the Engineering Systems Division  
on May 1, 2015, in partial fulfillment of the  
requirements for the degree of  
DOCTOR OF PHILOSOPHY

## Abstract

Scarce pipeline capacity in regions that rely on natural gas technologies for electricity generation has created volatile prices and reliability concerns. Gas-fired generation firms uniquely operate as large consumers in the gas market and large producers in the electricity market. To explore the effects of this coupling, this dissertation investigates decisions for firms that own gas-fired power plants by proposing a mixed-integer linear programming model that explicitly represents multi-year pipeline capacity commitments and service agreements, annual forward capacity offers, annual maintenance schedules, and daily fuel purchases and electricity generation. This dissertation's primary contributions consist of a detailed representation of a gas-fired power-plant owner's planning problem; a hierarchical application of a state-based dimensionality reduction technique to solve the hourly unit commitment problem over different temporal scales; a technique to evaluate a firm's forward capacity market offer, including a probabilistic approach to evaluate the risk of forced outages; a case study of New England's gas-electricity system; and an exploration of the applicability of forward capacity markets to reliability problems for other basic goods.

Joseph Sussman  
Committee Chair  
Professor of Civil Engineering and Engineering Systems

Ignacio J. Pérez Arriaga  
Thesis Supervisor  
Visiting Professor of Engineering Systems

Ernest J. Moniz  
Cecil and Ida Green Professor of Physics and Engineering Systems

Mort Webster  
Associate Professor of Engineering Systems





## Acknowledgments

To everyone that has lent me an ear and indulged me by listening to my stories, I thank you for your time, support, advice, and companionship. With much gratitude, I assure you that it has truly been an unequal exchange to my benefit.

To my committee members:

Ignacio, thank you for introducing me to the world of electric power systems and regulation, especially even after you realized at our first meeting that I had no idea what the phrase “marginal cost of electricity” meant! Who would have guessed after that meeting that I would spend three of the next five years as your teaching assistant and then continue onward to finish an entire dissertation on power systems?

Joe, thank you for your genuine interest in my research, your thoughtful questions, and your careful stewardship of my doctoral program. I am deeply grateful for your close attention and presence on my committee, and I will always remember that steak is easier to eat than lobster when writing.

Mort, thank you for your courses in dynamic programming and power system optimization modeling; they were a helpful start into the world of mathematical modeling.

Ernie, thank you for the opportunity to contribute to The Future of Natural Gas Study five years ago—the start of everything that led to this dissertation!

This research was funded by the NSF, the MITEI Energy Initiative, and the Comillas-MIT-Electricity Systems (COMITES) partnership.

THIS PAGE INTENTIONALLY LEFT BLANK

# Contents

<b>1</b>	<b>Introduction</b>	<b>17</b>
1.1	History and context . . . . .	21
1.1.1	A brief introduction to electric power systems . . . . .	21
1.1.2	A brief introduction to the natural gas system . . . . .	26
1.2	Contemporary challenges for decision makers . . . . .	34
1.2.1	Key decision makers . . . . .	34
1.2.2	Common concerns . . . . .	36
1.2.3	The need for new decision support models . . . . .	37
1.3	Research statement . . . . .	44
1.3.1	Strategic decisions . . . . .	44
1.3.2	Dimensionality challenges . . . . .	50
1.3.3	Next steps . . . . .	51
<b>2</b>	<b>Combined Gas-Electricity</b>	
	<b>Planning &amp; Operation Model</b>	<b>55</b>
2.1	General economic assumptions . . . . .	56
2.1.1	Welfare-maximization and cost-minimization . . . . .	57
2.1.2	Perfect competition . . . . .	57
2.2	Full hourly model description . . . . .	60
2.2.1	Unit commitment with gas transportation . . . . .	64
2.2.2	Long-term service agreement selection . . . . .	67
2.2.3	Maintenance scheduling . . . . .	68
2.2.4	Forward capacity . . . . .	71

2.2.5	Considerations for uncertainty . . . . .	74
2.3	Dimensionality reduction . . . . .	76
2.3.1	System state representation . . . . .	80
2.3.2	System state implementation . . . . .	84
2.4	Summary and next steps . . . . .	93
<b>3</b>	<b>Case study</b>	<b>95</b>
3.1	Input data . . . . .	96
3.2	Benchmarks . . . . .	99
3.2.1	System state versus hourly unit commitment . . . . .	100
3.2.2	Isolated decisions . . . . .	104
3.2.3	Simultaneous decisions . . . . .	114
3.3	Hypothetical explorations . . . . .	123
3.3.1	Full-sized power system . . . . .	123
3.3.2	Explorations under uncertainty . . . . .	135
3.4	Conclusions . . . . .	146
<b>4</b>	<b>General lessons</b>	<b>149</b>
4.1	A description of electricity . . . . .	151
4.1.1	Defining features . . . . .	152
4.1.2	Commodity versus basic good . . . . .	153
4.2	Lessons from New England . . . . .	155
4.2.1	New England’s original forward capacity market . . . . .	157
4.2.2	New England’s new forward capacity market . . . . .	158
4.2.3	Winter reliability program . . . . .	160
4.3	The role of indicative and mandatory planning . . . . .	162
4.4	Forward capacity markets for basic goods . . . . .	165
4.4.1	Forward capacity markets for pharmaceuticals . . . . .	167
4.4.2	Forward capacity markets for water . . . . .	168
4.5	Conclusions . . . . .	170

<b>5</b>	<b>Conclusions</b>	<b>171</b>
5.1	Contributions . . . . .	172
5.2	Findings . . . . .	173
5.3	Limitations and future work . . . . .	176
<b>A</b>	<b>Gas-electricity price dynamics</b>	<b>181</b>
<b>B</b>	<b>Matlab and GAMS code</b>	<b>217</b>

THIS PAGE INTENTIONALLY LEFT BLANK

# List of Figures

1-1	Electric power grid diagram <sup>1</sup> . . . . .	21
1-2	Independent system operators in the United States . . . . .	23
1-3	Natural gas geology . . . . .	27
1-4	Map of natural gas basin and transportation corridors in the United States, 2008 . . . . .	28
1-5	Map of natural gas market centers in the United States, 2009 . . . . .	32
1-6	Gas and electricity market timing, New England, 2013 . . . . .	37
1-7	Stylized representation of different maintenance interval functions for long-term service agreements . . . . .	47
2-1	Block diagram of feedback between long-, medium- and short-term decisions . . . . .	79
2-2	Stylized unit commitment results . . . . .	81
2-3	Identifying system states using $k$ -means clustering . . . . .	82
2-4	Each hour is assigned to the most similar cluster . . . . .	83
2-5	Tracking hourly trends and dynamics . . . . .	84
3-1	New England gas and electricity price correlation . . . . .	96
3-2	2013 New England Annual Electricity Demand . . . . .	98
3-3	New England Electricity Demand, April 11-18, 2013 . . . . .	98
3-4	New England Electricity Demand, July 15 to July 22, 2013 . . . . .	98
3-5	2013 Algonquin Gas Prices (based on EIA data) . . . . .	99
3-6	System state approximation of electricity demand . . . . .	101
3-7	One-month dispatch: (top) system state; (bottom) hourly formulation	102

3-8	Isolated long-term pipeline firm transportation decision . . . . .	106
3-9	Estimation of firm 2's daily short-term gas purchases for 2013 . . . . .	108
3-10	Isolated long-term service agreement decision . . . . .	110
3-11	Estimated available gas-fired power plant capacity based on aggregate scheduled outages (long-term approximation) . . . . .	111
3-12	Estimated available gas-fired power plant capacity based on aggregate scheduled outages (medium-term solution) . . . . .	112
3-13	Forward capacity commitment for different long-term pipeline trans- portation prices . . . . .	114
3-14	Long-term gas purchase, all decisions enabled: (top) no transportation cost; (middle) pipeline scarcity; (bottom) gas uncertainty . . . . .	116
3-15	LTSA, all decisions enabled: (top) no transportation cost; (middle) pipeline scarcity; (bottom) gas uncertainty . . . . .	118
3-16	Maintenance schedule, all decisions enabled: (top) no transportation cost; (middle) pipeline scarcity; (bottom) gas uncertainty . . . . .	120
3-17	Forward capacity, all decisions enabled: (top) no transportation cost; (middle) pipeline scarcity; (bottom) gas uncertainty . . . . .	122
3-18	Long-term gas purchase, full power system . . . . .	124
3-19	Estimated annual fuel purchases, full power system . . . . .	127
3-20	LTSA selection, full power system . . . . .	129
3-21	Maintenance schedule, Firm 2 . . . . .	130
3-22	Maintenance schedule, Firm 3 . . . . .	131
3-23	Weekly energy output, long-term pipeline transportation price: \$1/MMBtu	132
3-24	Weekly energy output, long-term pipeline transportation price: \$100/MMBtu	132
3-25	Annual forward capacity commitments . . . . .	133
3-26	Annual forward capacity profits . . . . .	134
3-27	Annual energy profits . . . . .	135
3-28	Forward capacity obligation risk . . . . .	141
3-29	CDF of marginal electricity prices . . . . .	143
3-30	Risk premium and risk aversion in forward capacity bid . . . . .	143



3-31 Long-term pipeline transportation purchases with risk aversion . . . . 145

THIS PAGE INTENTIONALLY LEFT BLANK

# List of Tables

3.1	Summary of dispatchable ISO-NE power plants, 2013 . . . . .	97
3.2	System state versus hourly unit commitment results . . . . .	104
3.3	System state versus hourly unit commitment computation details . .	104
3.4	Power plant data subset for exploring isolated decisions . . . . .	105
3.5	LTSA/long-term pipeline transportation operations and costs compar- ison for a representative power plant . . . . .	129
3.6	Gas and electricity uncertainty scenarios . . . . .	136
3.7	Firm 2's forward capacity market bid information (\$10/MMBtu/day firm transportation) . . . . .	139

THIS PAGE INTENTIONALLY LEFT BLANK

# Chapter 1

## Introduction

Natural gas-fired power plants accounted for 18% of New England's total power plant capacity in the year 2000. Fifteen years later, due to a confluence of environmental and economic factors, natural gas has displaced much of the remaining coal and oil capacity in the region and now accounts for 50% of New England's total power plant capacity and over 40% of its total electricity generation. As the electric power sector increasingly depends on natural gas as a primary fuel, and as the electric power sector becomes the gas sector's largest consumer, public agencies such as the Independent System Operator of New England (ISO-NE), the New York Independent System Operator, and the Federal Energy Regulatory Commission (FERC) and private consortiums such as the Edison Electric Institute and the Interstate Natural Gas Association of America have expressed concerns about the increasing regularity of pipeline capacity scarcities and the long-term implications of reduced fuel diversity for electric power system reliability. [FERC, 2012][ISO-New England, 2013a]

Although the United States' northeast region is the first in the country to experience emerging problems due to the interdependencies between its gas and electricity systems, its shift toward natural gas technologies is not unique. The United States' electric power sector in aggregate now burns so much natural gas that it has displaced both industrial and residential sectors as the country's top consumer. [EIA, 2013] The strong adoption of natural gas technologies is not surprising given the niche role that natural gas-fired power plants fulfill. Compared to their coal counterparts, gas-fired

power plants emit fewer greenhouse gasses. In many parts of the United States and other parts of the world with shale gas reserves and sufficient gas transportation infrastructure, the commodity price of natural gas economically outcompetes coal. And compared to both coal and nuclear power plants, gas-fired power plants provide short-term operational flexibility<sup>1</sup> that allows power systems to integrate more intermittent and variable technologies such as renewable wind turbines and photovoltaic solar cells. The environmental and operational advantages of gas-fired power plants have led power systems not only in the United States, but also around the world, to adopt increasingly larger fractions of natural gas technologies into their capacity mix.

For example, at the end of 2013, the Spanish power system had 102,395 MW of total installed capacity for electric power generation consisting of 22.3% wind turbines and 24.8% combined-cycle gas turbines (CCGTs)<sup>2</sup>. Despite the similar installed capacities of both technologies, in 2013, wind turbines covered 21.2% of Spain’s electricity demand, while CCGTs only covered 9.5%. [Eléctrica, 2014] Given Spain’s relative isolation as a power system from other countries (with exception to its connection to Portugal, whose power system is about one-fifth the size of Spain’s with a similar capacity mix), the system operator only considers 5% of its total installed wind capacity as “firm,”<sup>3</sup> and the system operator relies on the ramping and cycling capabilities of gas-fired power plants and storage from pumped hydro turbines to mitigate short-term imbalances between electricity supply and demand. Although the load factor<sup>4</sup>

---

<sup>1</sup>Gas-fired power plants can physically start up, shut down, and change their power output levels faster than any other thermal technology. These “cycling” and “ramping” advantages allow gas-fired power plants to follow unexpected dips and rises in demand and generation, which in turn helps power systems maintain the physical supply and demand balance required at all time instances to prevent power failures such as blackouts and brownouts.

<sup>2</sup>CCGTs are a specific type of gas-fired power plant that combines an open-cycle combustion turbine with a steam turbine. The combustion turbine resembles the turbine design of a jet engine (at least to a first approximation) and can turn on and off quickly. The excess heat given off by the combustion process then heats water until it turns to steam, and this steam powers a separate turbine. Modern CCGTs can have energy conversion efficiencies exceeding 60%.

<sup>3</sup>Firm capacity refers to the amount of capacity that can be considered always available; because wind turbines can only produce electricity when there is wind, wind turbines (and other renewable technologies) tend to have lower firm capacities as a fraction of their total installed capacities relative to thermal plants.

<sup>4</sup>The load factor of a power plant represents how much energy a plant generated as a fraction of the total energy that it could have generated were it operating at full load for the entire time period. Technologies with high capital expenses frequently require high load factors to recover their

for Spain's CCGT fleet is low, Spain's CCGT power plants, in combination with its pumped hydro resources, are critical to ensuring the reliability of the Spanish power system due its large share of wind generation and lack of import/export capacity with other countries. [MITEI, 2011a]

However, Spain's success with wind and gas is not without its own problems: Spain, Germany, and other power systems with a large penetration of renewables have experienced financial difficulties maintaining their gas-fired generation power plants due to low load factors and marginal pricing pressures from renewables. [Economist, 2013] These international experiences and emergent reliability concerns in New England suggest that as power systems around the world increasingly depend on gas-fired generation for a variety of environmental, economic, and safety reasons, the status quo of natural gas as a reliably available fuel and gas-fired power plants as a reliably available technology may no longer hold.

The electric power sector's current level of demand for natural gas has already led to greater fuel uncertainty and cost due to physical transportation constraints and geopolitical concerns around the world. In the United States, natural gas is plentiful due to advances with hydraulic fracturing, but pipeline capacity is not always available. The difficulty that generation firms face projecting their gas consumption up to twenty years into the future compared to other types of large natural gas consumers has reduced long-term commitments to purchase gas and depressed investment signals for new pipeline capacity. [MITEI, 2013] New England currently experiences high electricity prices as a direct result of its extreme reliance on natural gas and the region's constrained pipeline capacity; for a detailed case study of the market dynamics in New England, see Appendix A. In European countries, the geopolitics surrounding natural gas supply can artificially and unexpectedly limit fuel availability. And in countries such as Japan with few natural gas reserves, limited pipeline infrastructure, and few alternative generation technologies due to safety concerns, additional reliance on natural gas can be exceptionally expensive. [Economist, 2014]

---

fixed costs; for example, nuclear power plants generally need to operate at load factors in the high 90th percentile to remain economically viable. [Nuttall, 2011]

Each of these situations highlights potentially problematic physical, economic, and social interactions between gas and electricity systems that can materially impact one or both energy system’s reliability.

This dissertation seeks to contribute new knowledge about the emerging interdependencies between coupled gas and electric power systems by examining the optimal behavior of a central group of agents in both systems: generation firms that own gas-fired power plants. Unlike other important agents such as monopolistic local distribution companies who deliver gas to captive consumers at regulated rates, or industrial users who consume natural gas as a raw input for manufacturing and have relatively predictable and inelastic demand, generation firms with gas-fired assets operate with a unique set of uncertainties as simultaneous consumers in gas markets and producers in electricity markets. Given the physical and financial coupling between gas and electricity systems, understanding how firms that own gas-fired generation plants should operate under uncertainty from electricity demand, renewable generation, and gas transportation availability over a range of timescales can provide insights about potential changes to operations, regulations, or policies in one or both energy systems that may improve reliability and economic efficiency.

To explore the optimal behavior of firms that own gas-fired generation plants, this dissertation develops a mixed-integer linear programming (MILP) model of a generation firm’s post-investment operations decisions over a timescale ranging from the next day to the next three years. This dissertation also demonstrates a temporal framework based on a state-based dimensionality reduction technique to separate the unified MILP problem, which is currently computationally intractable, into a series of smaller subproblems that can be individually solved and then reintegrated. The resulting decisions approximate solving the unified MILP problem simultaneously such that relevant short-timescale effects can be considered in long-timescale decisions, and long-timescale decisions condition the feasible set of future short timescale decisions.

The remainder of Chapter 1 provides an overview of gas and electric power systems and outlines the key problems that this dissertation examines. Chapter 2 describes the mathematical models developed to analyze interconnected gas-and-electricity sys-



tems; Chapter 3 applies the models to a real-sized case study power system inspired by New England; Chapter 4 explores the application of forward capacity markets to other basic goods; and Chapter 5 concludes.

## 1.1 History and context

The next two sections, 1.1.1 and 1.1.2, provide primers for readers that are new to gas and electricity systems. Readers that have familiarity with these topics can skip directly to section 1.2, which describes present day challenges for key decision makers.

### 1.1.1 A brief introduction to electric power systems

#### The physical network

The primary function of electric power systems is to reliably deliver electricity from generators to consumers. Physically, an electric power network consists of a high voltage transmission network and several medium and low voltage distribution networks. High-voltage transmission wires connect generators (such as coal or natural-gas fired power plants) to each other, to large consumers, and to substations. Substations transform high voltage electricity to lower voltages and then distribute the electricity to small business and residential consumers. Figure 1-1 illustrates the physical connections between each of the elements in a power system.

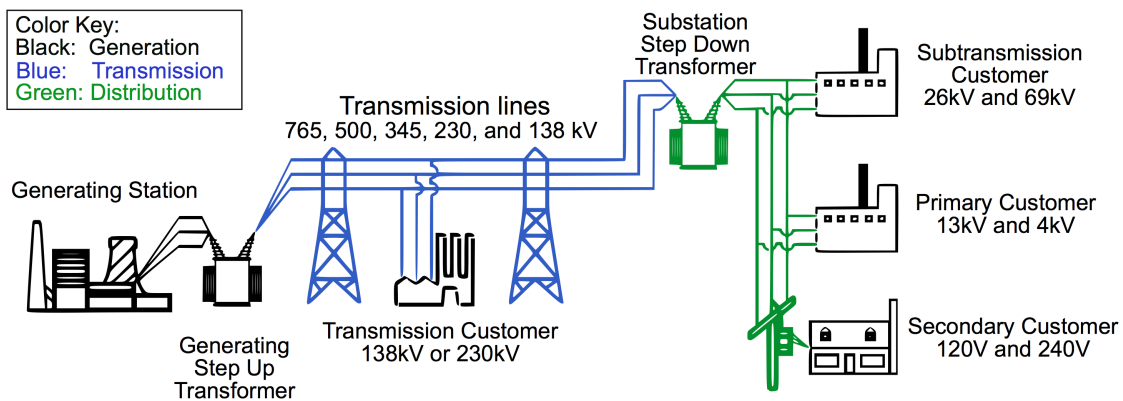

Figure 1-1: Electric power grid diagram<sup>5</sup>

At high voltage, the transmission grid ties together the activities of all generators, forming one monolithic machine that rotates at 60 Hz in the United States (50 Hz in other parts of the world), spans thousands of miles, and constantly converts mechanical energy into electrical energy. The physical operation of this machinery resembles an intricate, synchronous dance between giants—because we currently cannot economically store vast amounts of electricity in the same manner that we can store other commodities such as oil, electric power systems must balance uncertain demand and supply at every time instant. If there is too little demand, unconsumed energy stored in the electromagnetic field of transmission wires causes every turbine that is connected to the grid to rotate faster. The reverse is also true: if there is too much demand and not enough electrical energy, the demand acts as a force against the motion of every connected turbine. This physical coupling is one of the reasons that electric power systems serve as an excellent example of a complex sociotechnical system. In developed countries, societies view electricity as a right and continue to demand (by way of laws and public opinions) not only reliable electricity, but also environmentally friendly and “safe” electricity despite the additional uncertainties and operating difficulties that technologies with these attributes can introduce into the daily operation of power systems.

### **Wholesale electricity markets**

Before the 1990s, most consumers purchased electricity from vertically integrated utilities that controlled all aspects of the electricity business. These monolithic utilities operated as local monopolies over a particular geographic region and made decisions ranging from long-term, multi-decade generation and transmission investments to short-term, hourly plant operations. Government regulators monitored the prices that companies could charge and the total revenues that they could earn, and companies passed along all regulator-approved costs to their customers.

In the 1990s, a few governments in South America, Europe, and the United States

---

<sup>5</sup>Media source: [http://upload.wikimedia.org/wikipedia/commons/4/41/Electricity\\_grid\\_simple\\_North\\_America.svg](http://upload.wikimedia.org/wikipedia/commons/4/41/Electricity_grid_simple_North_America.svg)

started to shift their electric power systems away from the vertically integrated business model and introduced wholesale electricity markets. In power systems that underwent market liberalization, governments created new system and market operators tasked with the responsibility of coordinating the activities of individual firms on the transmission network and clearing wholesale markets. During this liberalization process, electricity transmission and distribution networks remained regulated monopolies due to their inherent economies of scale. Advocates for wholesale electricity markets hoped that these reforms would enable competition between power generation firms, allow market forces to pick winners and losers, and promote greater price transparency. Despite these claimed benefits, planning and operating a reliable power system via wholesale electricity markets has not always proven successful, and many power systems continue to operate with a vertically integrated structure. The map in Figure 1-2<sup>6</sup> highlights regions in the United States that currently operate power systems with wholesale electricity markets.

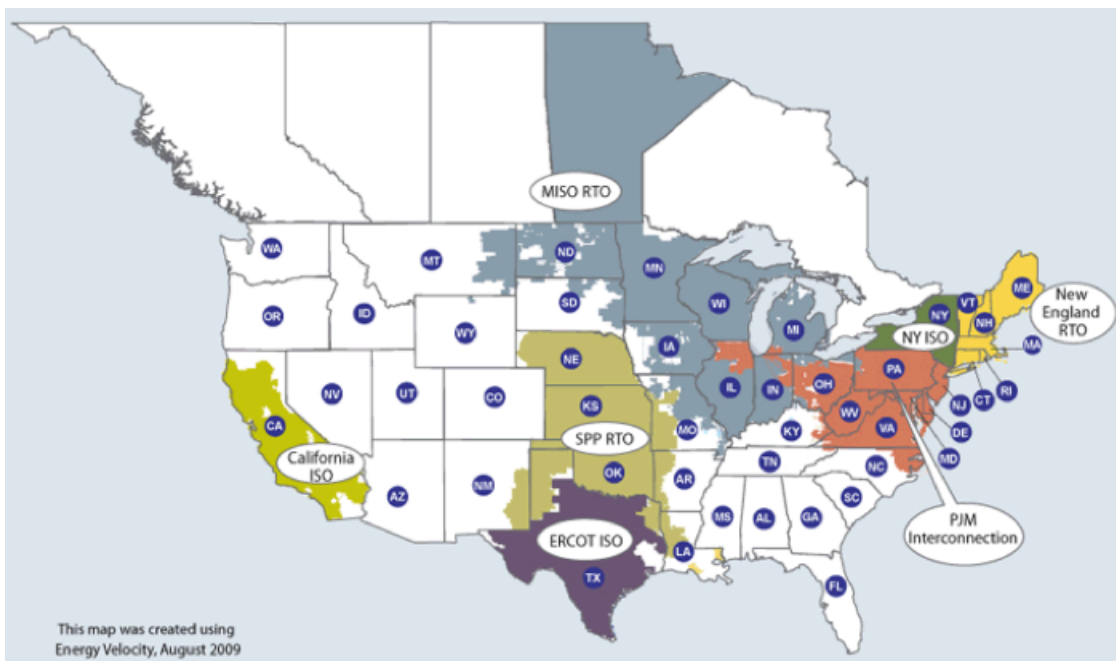

Figure 1-2: Independent system operators in the United States

Each of the independent system operators (ISOs) shown in Figure 1-2 coordinates

<sup>6</sup>Source: <http://www.ferc.gov/industries/electric/indus-act/rto/rto-map.asp>

system and market activities between the generators and large-scale consumers that reside within its geographic region. Large-scale consumers include businesses that directly connect to the transmission network, as well as utilities that buy electricity to sell to end-use residential and small business consumers. Each ISO runs auctions for the electricity commodities/products that it needs. For example, energy (electricity provided to the customer and measured in megawatt-hours) is one such product. Ramp up and ramp down capabilities (measured in megawatts/minute), which allow a system operator to meet variations in demand on the timescale of a few minutes to an hour, are another such product. To participate in these auctions, generators must submit bids consisting of quantity and price pairs that they are willing to sell each electricity product for, as well as other variable and fixed cost information, such as the cost of operations and maintenance for operating a plant, the cost of starting a plant, and the cost of shutting down a plant. After collecting all supply offers and demand bids for each hour of the next day, the ISO ranks plants based on price and physical network feasibility and then awards bids starting with the least expensive plant. The last bid that the ISO accepts sets the marginal system price that all generators receive for their electricity product, and generators with bids that exceed the highest price receive no money in this particular round of bidding. Consequently, the marginal system price for an electricity commodity also serves as an investment signal about the potential value of investing in new technologies and capacities that can provide that commodity. This feedback loop between consumers and generators, ideally, results in an economically efficient (welfare-maximizing) procurement of all of the electricity commodities that the system operator defines.

As with other markets, electricity markets operate on the economic principle that perfect competition should produce efficient outcomes. With proper incentives and information about electricity prices, load trends, generation technologies, and other pertinent aspects of the power system, power generation firms should be able to compete with each other by making prudent investment and operation decisions that maximize not only their own individual profits, but also the overall welfare of the power system. However, in reality, many market failures exist that can skew these

outcomes. For example, as most power systems only have a few generation companies, the oligopolistic nature of this group may allow price fixing, even if every company “competes” to sell electricity. Electricity price caps set by system operators provide another example of a potential market failure. Although price caps prevent consumers from paying high prices, they also prevent investors from receiving correct marginal pricing information and accurately assessing potential investment opportunities. Because of these types of market failures, over the last two decades in power systems, “liberalization” and “deregulation” efforts to shift away from vertically integrated business models have actually led to a need for more and better regulation—not less.

### **Regulatory challenges**

During the market liberalization process that took place in the late 1990s and early 2000s, governments implicitly delegated the long- and short-term responsibility of supplying electricity collectively to individual firms (agents) operating in their own best interests under market rules. Regulators suddenly faced a new set of questions. For example, in a properly functioning, welfare-maximizing market, what electricity commodities should agents trade? What is the hypothetical market optimum, and what are the corresponding “correct” individual investment and operation decisions? How should decision makers address market power concerns and market failures that might create deviations from the hypothetical optimum? When decision makers introduced wholesale electricity markets in an attempt to improve technology adoption, innovation, competition, transparency, and efficiency, they made electric power systems wholly dependent on the rational behavior of individual firms to guarantee reliable and secure electricity supplies and introduced an entirely new set of regulatory questions; for a comprehensive review of regulation for the electric power sector, see [Pérez-Arriaga, 2013].

Just as liberalization introduced a new set of questions for the electric power sector, the recent discovery of abundant natural gas supplies and increasing worldwide dependence on natural gas and renewable technologies, for reasons that are not

necessarily easy to capture with markets, are creating a new set of challenges for the operation and regulation of electric power systems. For example, how should individual firms manage operational uncertainty? Should market operators modify their rules to allow firms to express uncertainty—and if so, how? How should policy makers design technology-neutral laws and incentives to promote reliability? How should regulators measure and mitigate the substantial market power that gas-fired power plants have in systems that rely heavily on gas-fired generation and have limited pipeline capacity? These types of questions represent the emerging regulatory, reliability, and investment concerns that public and private stakeholders in gas and electric power systems will increasingly have to tackle as coupled gas and electric power systems continue to evolve.

### **1.1.2 A brief introduction to the natural gas system**

#### **Physical natural gas network**

Much like electricity networks, the primary function of gas networks is to transport natural gas—primarily methane—from production sites to end consumers. Production firms use a variety of techniques to extract gas from the ground, but the process broadly entails drilling into the ground to expose a deposit of gas and then installing a wellhead to capture and control the newly released gas. Traditional deposits appear as large “bubbles” of methane surrounded by earth that can be reached by drilling vertically into the ground. Recently, however, horizontal drilling techniques and hydraulic fracturing (colloquially, “fracking”) have enabled substantial recovery of “unconventional” natural gas from shale rock formations that trap many small pockets of methane in the ground; see Figure 1-3<sup>7</sup> for an illustration of the different types of gas deposits. For a detailed review of natural gas supply and production, see [MITEI, 2011b].

---

<sup>7</sup>Source: <http://www.eia.gov/todayinenergy/detail.cfm?id=110>

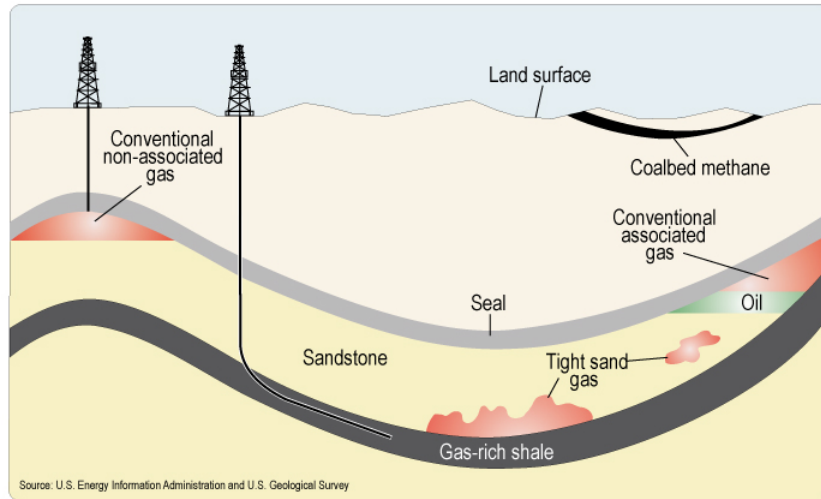

Figure 1-3: Natural gas geology

Natural gas can be stored in pipelines by compression (the amount of gas stored in a pipeline at any given time is known as “linepack”), and natural gas moves through pipelines based on pressure differences between two points. Compressor stations distributed throughout the network can repressurize pipelines as necessary, and the reliable operation of pipelines requires a minimum threshold pressure throughout the system. Notably, as a distinction from power systems, natural gas systems can manage moderate demand and supply imbalances at short timescales on the order of a few hours because pipelines inherently store natural gas. Figure 1-4<sup>8</sup> illustrates the major gas production sites and transportation corridors (composed of one or more pipelines) for natural gas in the United States.

<sup>8</sup>Source: [http://www.eia.gov/pub/oil\\_gas/natural\\_gas/analysis\\_publications/ngpipeline/TransportationCorridors.html](http://www.eia.gov/pub/oil_gas/natural_gas/analysis_publications/ngpipeline/TransportationCorridors.html)

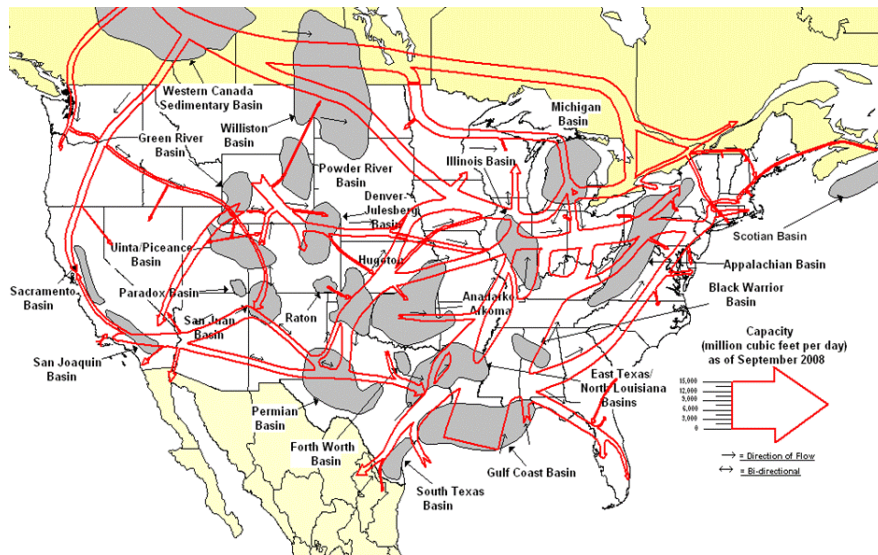

Figure 1-4: Map of natural gas basin and transportation corridors in the United States, 2008

Like electricity transmission networks, gas pipelines have finite capacity. However, securing rights to use pipeline capacity differs substantially from allocating scarce transmission capacity for power systems in the United States. Whereas each independent system operator in a power system considers physical constraints when clearing its markets and making scheduling/dispatch decisions, the gas system does not have an equivalent centralized system operator. Gas “shippers”—a term that describes any firm that needs to ship or receive gas—must acquire capacity rights along the entire transport path from the point of injection to the point of withdrawal, and most gas transactions occur as bilateral arrangements between independent firms. Large consumers, such as industrial users and power generation companies, can directly connect to high-pressure pipelines and make their own shipping arrangements. Small businesses and residential consumers, as in the electric power system, typically receive their gas through an intermediate utility company that secures supplies of natural gas on their behalf. Pipeline operators ensure that nominations<sup>9</sup> to use pipeline capacity are physically feasible and make adjustments as necessary based on who owns and has priority to pipeline capacity, but they do not operate or clear

<sup>9</sup>This is an industry term of art that refers to the physical flow schedule that a shipper proposes to a pipeline operator.



centralized markets in the same manner that ISOs do for electricity.

The differences between the centralized nature of electricity markets and the bilateral nature of gas markets in the United States has its roots in the natural gas sector's regulatory evolution.

## **Regulatory history**

The history of the United States' natural gas sector and its regulation provides a useful context for understanding how the natural gas system works and the broad challenges that coupled gas-electricity systems face, as well as for identifying key decision makers. The existing literature on natural gas regulation in the United States includes comprehensive papers by authors such as [Juris, 1998], who describes the current state of gas trading in the United States; [Makholm, 2006], who examines the changing environment for pipeline investments and long-term contracts from the early 1900s onward, paying special attention to the asset specificities of the business that made pipeline investments a unique challenge for the gas industry; and [Petrash, 2005], who analyzes the decline of long-term capacity contracts and the growing preference for short term commitments after the start of deregulation and liberalization in the 1980s.

Regulation of the natural gas industry in the United States has dramatically changed since the 1930s, when the industry was vertically integrated, to today's competitive trading markets and regulated pipeline monopolies. Before the early 1900s, the gas industry operated as a collection of vertically integrated utilities. As noted by both [Makholm, 2006] and [Petrash, 2005], vertical integration made sense absent further regulation because this organization structure eliminated the financial risk that producers and pipeline operators faced due to the asset-specificity of their gas fields and pipelines. Because of the limited number of consumers at the end of a pipeline, downstream consumers could "hold up" the upstream agents and put them at financial risk once these agents constructed a pipeline and started producing gas. To mitigate the risk of "hold up" in the earliest days of the natural gas industry, companies vertically integrated the production, transportation, and distribution functions of

their business.

The discovery of large deposits of gas in the early 1900s led both oil companies and natural gas utilities to begin building long, interstate pipelines that could transport gas to local markets across the country. After Congress passed the Natural Gas Act (NGA) in 1938 to regulate interstate pipelines, long-term bilateral sales contracts emerged as a viable business structure. These bilateral contracts between pipeline operators and producers, and between pipeline operators and distributors, specified “bundled” sales of both gas commodity and transport capacity. Section 7 of the NGA facilitated the development of these long-term contracts by granting the federal regulator the authority to approve new pipeline construction projects if operators could demonstrate long-term demand for new capacity. At the time, the Federal Power Commission (FPC) required proof of long-term demand for capacity from both producers and consumers, leading producers and distribution companies to sign long-term purchase and sales contracts with pipeline operators. The time duration of these long-term supply contracts—typically twenty years—mitigated the financial risks of “hold-up” and became the dominant financing model for the gas industry until liberalization efforts began in the late 1970s. [Petrash, 2005]

Initially, the NGA only regulated the price of bundled sales between pipeline operators and distributors. In the 1950s, however, after concerns about the market power of producers, the FPC gained additional authority to also regulate the wellhead prices that producers could charge for their gas, and pipeline operators became merchants with regulated prices at both ends of their pipelines. From the 1950s to the 1970s, perpetually low wellhead prices created a difficult cost recovery environment for producers, resulting in gas shortages in the early 1970s. [Petrash, 2005] Although different agents operated the production, transportation, and distribution segments of the natural gas industry from the 1930s to 1978, the industry was “de facto vertically integrated” because of the nature and duration of the long-term bilateral contracts, as well as the regulated prices that agents were allowed to transact at. [Juris, 1998]

In 1978, to address both lagging wellhead prices and gas shortages, Congress passed the Natural Gas Policy Act and gave the Federal Energy Regulatory Commis-

sion (FERC; the successor to the FPC) the authority to regulate both interstate and intrastate gas prices. FERC began liberalization efforts to introduce more competition into the natural gas industry. To date, the most important rules include FERC Orders 436, 500, and 636. FERC Order 436 opened access to interstate pipelines, allowing pipeline companies to unbundle gas commodity from transportation sales and allowing consumers and producers to directly buy and sell from each other while paying the pipeline operator a regulated fee for access. FERC Order 500 allowed pipeline operators that unbundled to collect tariffs that would offset long-term purchase contracts that they had previously signed with producers. FERC Order 636 required pipeline operators to become a “pipelines-only” company by releasing all companies that had previously signed long-term agreements with pipeline operators from their contractual obligations, forcing pipeline operators to divest all of their existing supply contracts, and setting up pipeline operators as regulated monopolies that would earn a fixed rate of return based on transportation volumes. The combination of FERC Orders 436, 500, and 636 created the modern gas system in the United States, which operates with many functional parallels to the electric power system sans a central coordinating agent. [Petrash, 2005]

### **Current natural gas market in the United States**

Today, natural gas trading in the United States resembles to a first approximation the idealized economic description of a commodity: each unit is homogenous, and the cost of natural gas reflects the commodity cost plus the cost of transportation. Pipeline operators hold the responsibility of making investments in new pipeline infrastructure subject to FERC approval, and these operators auction off capacity rights of varying time durations and guarantees of availability to shippers (a collective term that encompasses both producers and consumers). The price of natural gas at Henry Hub, a physical location in the United States where many pipelines meet (see Figure 1-5 for a map of some of the natural gas market centers in the United States<sup>10</sup>), is

---

<sup>10</sup>Source: [http://www.eia.gov/pub/oil\\_gas/natural\\_gas/analysis\\_publications/ngpipeline/MarketCenterHubsMap.html](http://www.eia.gov/pub/oil_gas/natural_gas/analysis_publications/ngpipeline/MarketCenterHubsMap.html)

generally considered the commodity cost of natural gas because capacity rarely (if ever) is scarce.

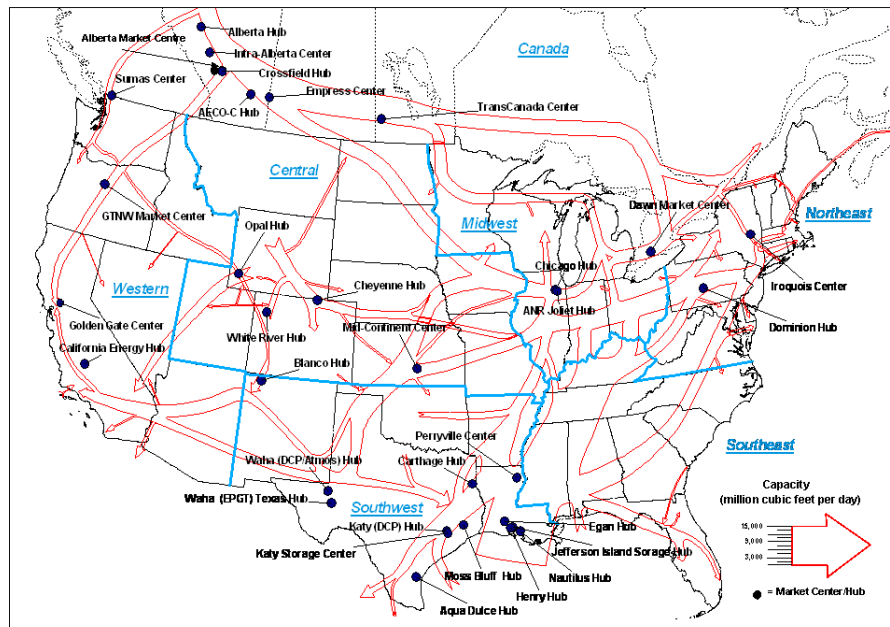

Figure 1-5: Map of natural gas market centers in the United States, 2009

The price differential between Henry Hub and other hubs around the country, such as New England’s Algonquin, reflects the transportation cost between these two hubs. The entire country shares a single gas trading day with multiple intraday renomination periods to balance supply and demand.<sup>11</sup> However, pipeline capacity transactions remain predominantly bilateral; due to the lack of a central system operator that coordinates both market and network activities, pipeline capacity may be underused in the United States given the complexity of needing to secure capacity rights at every physical point between the source and the destination. Third party marketers have emerged to remove some of the transactional complexity and inefficiency in matching supply and demand, but they do not occupy a role (nor have any authority) equivalent to the system operator in electric power systems. [Ruff, 2012] To ensure physical feasibility of flows, shippers must seek permission to use pipeline capacity

<sup>11</sup>The typical gas trading day only featured one or two intraday renomination periods prior to electricity-gas reliability concerns; today, in the United States, the gas and electricity industries are working together to increase the number of renomination periods.

that they either already own or acquired in a secondary market by submitting daily usage requests—capacity nominations—to pipeline operators.

### **Differences in the European Union market design**

The European natural gas system consists of an entry/exit design where the financial trading of natural gas tends to ignore network and temporal constraints within a trading zone—typically, a nation—and requires balancing at the boundaries of zones. Because the entry/exit design creates a “virtual hub” through which all gas producers ship gas to and all gas consumers receive gas from within a trading zone, the market design lacks a realistic representation of the underlying gas network’s pipeline structure. Consequently, costs for network usage within a trading zone tend to be socialized across all users because differences between supply and demand are balanced at the boundaries of the trading zone, and costs for gas that flows through multiple zones can result in a “pancake”<sup>12</sup> of access fees that do not necessarily reflect physical pipeline conditions from entry to exit. [Vazquez et al., 2012] Whereas gas costs in the United States tend to directly reflect underlying temporal and geographic pipeline scarcities in the same way that nodal prices in electricity markets reflect transmission constraints, the European design foregoes a physically-true representation in exchange for greater trading liquidity and socialized network access.

The European system promotes liquidity by removing substantial temporal and geographic network constraints within a trading zone so that injections and withdrawals that actually occur at different times and locations appear as if they occurred simultaneously. For example, if a producer injects gas at the beginning of the day in one physical location, and a consumer withdraws gas at a different time on the same day and at another physical location within the same trading zone (e.g., the same country), the European system financially clears this exchange as one simultaneous transaction. Abstracting the financial trading in this manner simplifies the transac-

---

<sup>12</sup>“Pancaking” of tariffs refers to the effect of stacking multiple access fees as the flow of a commodity crosses multiple geographic regions. In most cases, because the declaration of geographic regions is arbitrary and not based on physical network constraints, the tariff pancake does not properly allocate costs based on actual imposed costs on the network and benefits.

tion for producers and consumers: a unit of gas traded within one trading period in the same geographic zone has the same cost and value as any other unit of gas, even if in reality the time and location of the injection and withdrawal differ.

However, to accommodate the physical flows for this design, European network operators must necessarily withhold pipeline capacity from the market to flexibly respond to actual daily flows and imbalances that it cannot predict ahead of time. Europe's entry/exit design promotes pipeline investment within a virtual hub to support the financial abstraction of a universal entry/exit point, but does not necessarily promote cross-border investments. [Vazquez et al., 2012] Investment in European gas pipelines occurs at the suggestion of transmission system operators (TSOs) in conjunction with approval from the national regulatory authority (NRA) in each member state, and all agents in the system pay for the cost of investment via additions to each system's regulated asset base. [Barquín, 2012]

Despite the vastly different market designs for the European Union and the United States gas system, from the perspective of reliability concerns resulting from increasingly coupled gas and electricity systems, both regions share the same broad set of emerging challenges due to their shared physical reliance on natural gas, their shared uncertainty about fuel availability, and the similar roles that gas-fired power plants fulfill for electric power systems in each region.

## **1.2 Contemporary challenges for decision makers**

### **1.2.1 Key decision makers**

In the United States, the evolution of the electricity and natural gas sectors has created several key decision makers that wield influence over the combined gas-electricity system. This group includes electric power system operators, who clear markets and coordinate individual firm activities to ensure feasible network flows; natural gas pipeline operators who build and maintain pipeline infrastructure; wholesale shippers (a term that lumps together commodity producers, large consumers such as

utilities/local distribution companies (LDCs) and electricity generation firms, and third-party marketers that aggregate demand and supply) who trade natural gas commodity and transportation capacity amongst each other; wholesale electricity agents, such as generation firms and utilities/LDCs who trade electricity amongst each other; regulators such as FERC and state public utilities commissions (PUCs) who monitor both sectors, and policymakers at the state and federal level who craft legislation.

These key decision makers, from individual firms to pipeline operators and regulators/policy makers, also exist in similar capacities in the European Union. As of 2009, the European Union and its member states started to implement the “Third Energy Package,” an energy liberalization policy to create a single, unified market across member states for electricity and gas. In addition to creating a large trading region across the European Union, this liberalization policy unbundles gas commodity and pipeline ownership and institutionalizes cooperation amongst member state regulators via a mandate for each country to have a single NRA and the creation of the Agency for the Cooperation of Energy Regulators (ACER) to facilitate cooperation between NRAs. Two new institutions, the European Network of Transmission System Operators for Gas (ENTSOG) and the European Network of Transmission System Operators for Electricity (ENTSOE), play facilitating roles for each country’s gas and electricity system operators.

Comparing the European Union to the United States, loosely, the European member states map onto individual states in the United States in terms of the gas system and onto the individual system operators (ISOs) for the electricity system. The NRAs map to PUCs, and ACER maps to FERC. Although the United States lacks formal entities similar to ENTSOE and ENTSOG, adjacent electricity system operators cooperate frequently on an informal basis, and FERC’s Order 1000 gives electric power system operators the beginnings of regional planning authority across electricity systems. In the United States and the European Union, the physical similarities between each region’s gas and electricity systems and the existence of wholesale electricity and gas markets that economically guide the activities of individual firms—despite regulatory organization and market design differences—has created a common set of

reliability and security of supply challenges for all decision makers.

### 1.2.2 Common concerns

In 2012 and 2013, the New England States Committee on Electricity (NESCOE), an intrastate organization consisting of governor-appointed representatives from each New England state, discussed a variety of policy and market changes to New England's gas and electricity system to address the region's gas-electricity concerns. Their discussions summarize well the concrete challenges that coupled gas and electricity systems currently face. From market timing changes to new policies aimed at improving reliability, NESCOE's ideas include "moving the [electricity] day ahead market forward" to minimize uncertainty between gas and electricity needs (see Figure 1-6 for gas and electricity market timing in New England as of 2013); "allowing generators to reoffer hourly during the intraday period" to accommodate firms have electricity commitments but could not acquire the necessary fuel to meet them; allowing generation firms to "price risk into their offers" as an additional cost component in their bids to reflect the uncertainty of fuel availability; and creating "new ancillary services markets such as ones for longer term reserve products." NESCOE also discussed several capacity payment and regulatory alternatives to encourage fuel diversity and guarantee fuel availability, including "paying certain dual fuel capable units to hold/burn oil and maintain oil-burning capabilities;" "implementing rule changes that encourage better unit availability;" "paying supplemental capacity payments for generators that commit to firm gas supply;" "increasing payments to existing oil fired generators so that they don't retire;" "enhancing availability incentives to encourage gas-fired generators to contract for long-term pipeline capacity and/or storage;" "instituting rules that all gas fired generators must contract for long-term firm pipeline capacity;" "changing ISO-NE tariffs so that gas pipeline investment for generation purposes is socialized to all load;" and "establishing electricity reliability standards that would force generators to contract for new pipeline capacity." [Hunt et al., 2014] NESCOE's discussions and recommendations reveal that for stakeholders on the electricity side, the reduction of fuel diversity in the capacity mix combined with greater long- and



short-term uncertainty about natural gas availability pose the greatest challenges for coupled gas-electricity systems.

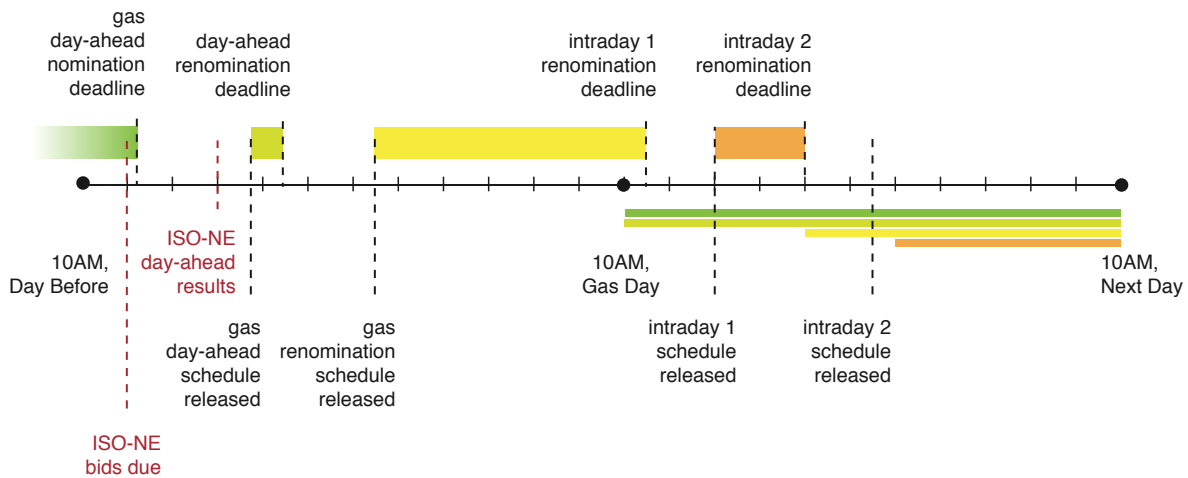

Figure 1-6: Gas and electricity market timing, New England, 2013

NESCOE’s discussions mirror similar concerns expressed by stakeholders in other electric power and gas systems. For example, see [Tabors et al., 2012] for an overview about market timing challenges and [FERC, 2012] for symposium discussions between public and private stakeholders in other gas-electricity systems in the United States. Given the similar roles that gas-fired power plants fulfill in power systems around the United States and the rest of the world, the emerging reliability problems described in these sources and above by NESCOE likely also affect other coupled gas-electricity systems that depend on natural gas for electricity generation, cannot easily/quickly switch away if faced with a scarcity of natural gas, and cannot guarantee fuel availability.

### 1.2.3 The need for new decision support models

NESCOE’s discussions about potential market and policy changes to reduce the probability of gas and electricity supply failures highlight the importance for decision makers to better understand the optimal decisions of generation firms. Firms that own gas-fired generation plants today in wholesale electricity markets operate under substantial uncertainty due to difficulty with forecasting pipeline scarcities and residual

electricity demands, especially in power systems with large renewable penetrations.

Prior to the large penetration of intermittent renewables and innovations in hydraulic fracturing techniques, electric power systems consumed less natural gas because other generation technologies provided sufficient operational flexibility and because gas-fired power plants, as a technology, were relatively expensive compared to other thermal technologies such as coal and nuclear. The level of pipeline investment in most regions sufficiently met the gas transportation needs of power systems. At the same time, electricity demand before renewables tended to exhibit predictable daily, weekly, and seasonal patterns that power plant owners and system operators could plan for. In this context, decision makers have historically placed less emphasis on the specifics of gas-fired power plants relative to other thermal power plants<sup>13</sup>, and the evolution of power system models and the details that they incorporate, reviewed below, have followed accordingly. The emerging dependence between gas and electricity systems has created a need for a new set of tools that can represent gas-fired power plants with greater nuance over longer timescales to support present day operations decisions and policy analyses.

In existing electricity optimization models ranging from long-term capacity expansion to medium-term hydrothermal coordination and short-term unit commitment/economic dispatch, a typical representation of a thermal power plant consists of a unit heat rate (or a piecewise linear heat rate curve) that describes the amount of fuel required to generate a unit of electricity, an additional unit cost on top of each unit of energy generated to account for operations and maintenance, fixed costs for starting and stopping a power plant, maximum rates at which a power plant can modify its output level per unit time, and minimum lengths of time that a power plant must stay on for after starting and off for after stopping. For a representative sample of foundational and current unit commitment papers that use this representation, see [Padhy, 2004]. This generic representation of thermal plants in optimization models treats a gas-fired power plant in the exact same manner as a nuclear plant or a coal

---

<sup>13</sup>For example, the annual regional system planning reports published by ISO-NE illustrate a progressive trend, starting in 2013, about the region’s gas and electricity difficulties; prior to 2013, gas did not appear as a potential reliability problem.

plant; in particular, this generic representation typically assumes that fuel is available with complete certainty, and the operations and maintenance of gas-fired power plants do not take into consideration the influence of long-term service agreements.

Optimization models are not the only types of electricity models that tend to group gas-fired power plants together with their thermal counterparts. Probabilistic reliability models also group gas-fired power plants together with other thermal plants, and these probabilistic models tend to treat plant failures from the perspective of mechanical forced outages. For example, see [Baleriaux et al., 1967], [Booth, 1972], and [Finger, 1975] for foundational papers in probabilistic production cost analyses of forced plant outages. In the 1990s, [Conejo, 1992] and [Maceira et al., 1996] contributed important extensions that allowed probabilistic production cost algorithms to more properly represent limited energy plants and storage technologies. These extensions could be applied to analyze the reliability characteristics of gas-fired power plants with limited fuel transportation by representing gas-fired power plant as a limited energy plant with inflows and outflows, but no storage. However, such an analysis would require assigning functional probability distributions to fuel availabilities, and unlike their optimization counterparts, probabilistic production models do not represent the power system with enough detail to make day-to-day operational decisions.

Of the authors that have studied the specific role of gas-fired power plants in power systems and the impacts of their strategic decisions on day-to-day operations, the substantial majority of existing work focuses on representing the constraints and decisions associated with the physical pipeline that delivers natural gas to generators. The earliest of these works focused on utilities that must purchase gas for not electricity generation, but for consumer end use. For example, on the problem of selecting long-term fuel contracts under demand uncertainty,

- [Guldman, 1983] uses a chance-constrained cost minimization model to explore tradeoffs of a take-or-pay contract in which the utility must also make storage and interruptibility decisions, taking into consideration the technological constraints of gas storage flows. (In a chance-constrained optimization, the

right-hand side constraint values represent probabilities.)

- [Fancher et al., 1986] demonstrates the implications of fuel burn uncertainty on take-and-pay contracts. The author describes coal consumption, but the paper can also be applied to gas.
- [Avery et al., 1992] discusses optimal purchase, storage, and transmission decisions for a utility that is obligated to serve small residential consumers and that serves larger consumers on an interruptible basis.
- [Guldmann and Wang, 1999] proposes a MILP to solve the LDC’s problem of optimally choosing supply contracts, taking into consideration contractual minimum take provisions and gas curtailment constraints.
- [Aouam et al., 2010] defines a combination strategy between a dynamic model that evaluates mean risk under stochastic demand and prices and a naive model that equally allocates procurement between storage, futures, and options. The authors create a convex combination of both strategies to minimize the mean and variance of procurement costs.
- [Koberstein et al., 2011] proposes a stochastic LP model that optimizes gas supply contracts, taking into consideration demand uncertainty, storage, and transportation.

Generation firms, of course, operate under a different business model than local distribution companies. LDCs, due to their regulated monopoly structure, are able to enter into long-term fuel contracts confident that they will earn enough from their captive consumers to repay their long-term commitments for fuel. Generation firms in wholesale electricity markets do not operate with the same guarantee, and consequently, face two broad problems related to gas availability and operating in gas markets. The first problem, frequently referred to as a “fuel-constrained unit commitment,” broadly asks how generation firms should optimally operate their power plants given a finite amount of available fuel. On this topic, authors have written the following representative papers:

- [Meeteren, 1984] presents an iterative LP unit commitment model that explicitly allocates limited fuel supplies to generation units in the system. The model generates fuel allocation solutions and unit commitment solutions separately and feeds the fuel allocation results as an input for the unit commitment problem.
- [Cohen and Wan, 1987] presents an iterative Lagrangian decomposition method for solving the fuel-constrained unit commitment problem where the fuel constraints are included in the primary objective function (i.e., the fuel allocation is not solved separately and then passed in as an input).
- [Vemuri and Lemonidis, 1992] presents an iterative, Lagrangean-relaxation-based approach for solving the fuel-constrained unit commitment problem. Vemuri's model, like Meeteran's, separates the fuel allocation and unit commitment problem into two separate optimizations.
- [Thompson, 1995] presents a lattice-based contingent claim model to evaluate take-or-pay and take-or-pay-with-makeup contracts.
- [Wong and Wong, 1996] presents a combined genetic algorithm/simulated annealing approach to solve the fuel-constrained unit commitment problem.

In addition to operating their generation assets under fuel constraints, generation firms also face a broad problem of deciding how to optimally participate as a consumer in one commodity market and a producer in another commodity market. The question of how much long-term gas transportation capacity to commit to is simply one example of a challenge that these firms must tackle; another example is the question of how much capacity to commit in a forward capacity market for electricity under fuel uncertainty. On the topic of making simultaneous decisions in both gas and electricity systems, authors have written the following representative works:

- [Lee, 1989] proposes a unit commitment model for Oklahoma Gas & Electric that takes into consideration significant fuel constraints from take-or-pay contracts and physical delivery constraints from the gas network.

- [Lee, 1991] proposes a model to optimize coordination between multiple constrained fuels for an electric utility (the contracts look like take-or-pay contracts, but there is no explicit underlift variable. The optimization requires fuel consumption between the min and max range).
- [Butler and Dyer, 1999] examines the value of three types of long-term fuel contracts to electricity generators;
- [Grossman et al., 2000] analyzes the value of long-term take-or-pay contracts for organizations that require fuel to produce another good for sale.
- [Chen and Baldick, 2007] presents a utility-maximization model for electric utilities that also own natural gas fired power plants and must make gas supply decisions in addition to electricity generation decisions. Instead of only minimizing total cost on the generation side, Chen’s mixed integer nonlinear programming model incorporates risk preferences for the electric utility with respect to how its total costs can change given its decisions in both gas and electricity markets.
- [Street et al., 2008] propose a stochastic model to price flexible gas supply contracts for power producers, taking into consideration electricity demand uncertainty and fuel unavailability uncertainty.
- [Vaitheeswaran and Balasubramanian, 2010] develops a risk-constrained expected fuel cost minimization model for an natural gas combined-cycle power producer, considering stochastic demand and gas prices.
- [Vaitheeswaran and Balasubramanian, 2012] develops a risk-constrained model (using the conditional value at risk metric) to solve the fuel allocation problem (how to allocate supply between various possible contracts) for the owner of a portfolio of natural gas plants.
- [Dueñas et al., 2012] describes a medium-term gas/electricity optimization model from the perspective of the generation company in which the generation company must make gas procurement and electricity generation decisions. The

model treats all price parameters as exogenous inputs, and gas contracts are treated as opportunity costs of purchasing gas at the contract price versus the spot price, as well as the opportunity cost of consuming or selling gas at the spot price.

Thus far, the substantial body of work on gas-electricity systems has focused on analyzing fuel constraints in the short term, with a handful of recent works focused on long-term strategic fuel decisions for generation firms. Regarding non-fuel-related problems that are specific to gas-fired power plants, [Troy et al., 2012] describes the impact of dynamic operations and maintenance costs on the unit commitment problem, and [Rodilla et al., 2014] presents an extension to the classic unit commitment model that incorporates the impact of long-term service agreements on a power system's short-term optimal dispatch schedule. Despite the material impact that specific features of gas-fired power plants can make on a power system's optimal operation, the survey of the existing literature on gas and electricity models shows that works such as [Troy et al., 2012] and [Rodilla et al., 2014] tend to be relatively rare. Several reasonable explanations exist for why this is the case. For example, in the past, gas-fired power plants did not play the large role in power systems that they do today and approximating gas-fired power plants as generic thermal plants may have sufficiently represented reality while simultaneously removing unnecessary computational effort. Alternatively, some gas-specific features, such as long-term service agreements, were not the norm a decade or two ago; [Sundheim, 2001] suggests as much. Consequently, these features did not appear in past model formulations because they, in fact, did not exist at the time. However, as gas and electricity systems become more interdependent and the firms that own gas-fired power plants exert more influence on both systems, the specificities of gas-fired power plants will rise in importance. To understand and act on emerging problems, decision makers today need a new set of tools that can examine the optimal behavior of firms that own gas-fired generation plants in gas and electricity markets over a range of timescales.

## 1.3 Research statement

To better understand how firms should make decisions in coupled gas and electricity systems, this dissertation develops a MILP model that explores the optimal behavior of firms that own gas-fired power plants. Based on the existing body of literature on the operation of gas-fired power plants, as well as current private and public discussions about notable attributes and decisions that impact today’s power systems (e.g., [FERC, 2012, MITEI, 2011a, Tabors et al., 2012, Barquín, 2012, MITEI, 2013, Hunt et al., 2014]), this dissertation focuses on how firms should make their fuel, maintenance, and generation decisions under uncertainty from fuel availability and electricity demand under the assumption of a perfectly competitive market. The following section describes each of the firm’s decisions that this dissertation will analyze, explains the dimensionality challenges that arise with modeling, and concludes with real-world hypotheses to explore.

### 1.3.1 Strategic decisions

#### **Long-term fuel contracts**

Pipeline operators have a fixed amount of pipeline capacity that they own and can auction to producers, local distribution companies, generators, and industrial users. To allocate this scarce capacity, pipeline operators offer different tiers of service that correspond to different tiers of interruptibility. Large, wholesale gas consumers must purchase gas contracts to secure transport capacity and commodity. Although gas contracts come in a variety of options, the most common classification of gas contracts is by level of transportation service and time duration. Transportation service levels range from completely firm (guaranteed capacity on the pipeline) to interruptible (no guarantee of capacity):

“A firm transportation contract allows the shipper to reserve a portion of the pipeline’s total delivery capacity for his own use. The shipper pays a monthly demand charge based on the maximum daily delivery quantity



contracted for, and a transportation charge for each unit of gas delivered. Additional pipeline transportation service is available on an interruptible basis. For interruptible transportation services the shipper generally pays only for the gas transported.” [Avery et al., 1992]

As an example of the different tiers of transportation service that pipeline operators offer, pipeline operator Transco notes that its interruptible contracts are subject to curtailment and interruption due to operating conditions and insufficient pipeline capacity. Interruptible contracts that flow to a downstream pooling point have higher priority than other interruptible contracts, but a lower priority than gas moving on a firm transportation contract. Transco’s consumers on interruptible contracts only pay for the volume of gas that they ship (as compared to shippers with firm contracts, who must pay for both the firm contract and the volume of gas shipped). [Transco, 2012] In addition to varying levels of service corresponding to varying guarantees of pipeline capacity availability, gas contracts can be broadly categorized by time duration as follows [Guldmann, 1983]:

- “Short-term contracts, where fixed daily volume deliveries, at fixed price, are arranged for one month or less; they allow for short-term unbalances in supply and/or demand to be corrected; such contracts make up what is called the spot market.”
- “Mid-term contracts, for periods of up to 18 months, with variable prices indexed to some future or spot price, and with fixed reservation and service fees, irrespective of volumes taken.”
- “Long-term contracts, for periods of 18 months to 15-20 years, with reservation fees and minimum take provisions; prices are indexed, and contracts often include renegotiating and market-out clauses.”

The generation firm’s long-term fuel contracting problem requires choosing the levels of transportation service to commit to, the time durations for each level of service, and the price for each contract. For a long-term firm-transportation contract, the

individual firm trades off paying for guaranteed access to a specific amount of pipeline capacity that it may or may not need in the future with the risk of not being able to acquire capacity that it does need at some later point in time.

### **Long-term service agreements**

When a generation firm purchases a new gas-fired power plant, typically it also purchases a matching long-term service agreement (LTSA) from the manufacturer. The LTSA covers maintenance that the power plant needs to continue operating normally; concretely, services may include semiannual plant inspections of the power plant's steam generators and turbines, mechanical repairs and parts replacements, and guarantees of financial compensation for the owner if the manufacturer is unable to restore the power plant to working condition within some prearranged time window. [Boyce, 2012, Thompson and Yost, 2014] LTSAs originated as a method for manufacturers and plant owners to share risk. Owners pay manufacturers a premium to guarantee the operation of their power plant and place a maximum cap on maintenance costs. Manufacturers, conversely, use their knowledge about their own equipment to reasonably estimate the total cost of maintenance assuming that firms operate their plants in an expected fashion and earn the difference between the owner's premium and the actual cost of maintenance. [Sundheim, 2001]

To ensure that generation firms operate their power plants "in an expected fashion," as part of their LTSAs, manufacturers define maintenance interval functions (MIFs) that dictate when an LTSA ends. A typical MIF contains the maximum number of firing hours, starts, and a function of the two that a plant can accumulate over the duration of its LTSA. As an example, Figure 1-7 represents three possible MIFs corresponding to three hypothetical LTSAs. Curve C represents the most flexible MIF because it allows all combinations of firing hours and starts that curves A and B represent, whereas curve A represents the most restrictive LTSA.

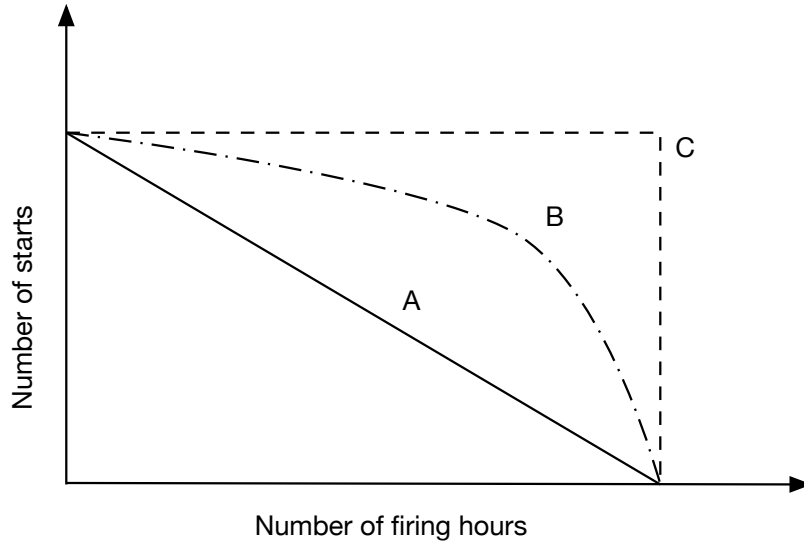

Figure 1-7: Stylized representation of different maintenance interval functions for long-term service agreements

The premium that an owner pays a manufacturer for maintenance under an LTSA covers the plant until it exceeds its MIF. Therefore, to make an optimal contract choice during the initial negotiation process, the power plant owner must decide how he intends to operate the plant over the duration of the LTSA. For example, consider a service agreement that allows a plant to accumulate a large number of firing hours, but a small number of starts. Under this service agreement, firms that operate their plants as peakers (i.e., with many starts and few firing hours) will reach the end of their LTSA far sooner than if they operated their plants as baseload units (i.e., with few starts and many firing hours). For more details on the specific attributes that manufacturers and power plant owners must agree upon when negotiating LTSAs, see [Sundheim, 2001], [Thompson and Yost, 2014], and [Boyce, 2012]. To make a reasonable contract choice, the power plant owner must somehow evaluate numerous future electricity and gas scenarios for the next three to five years (as an order-of-magnitude estimate, a typical LTSA might allow a gas-fired power plant to accumulate 25,000 firing hours and 200 starts).

LTSAs can present challenging economic issues for firms operating in power systems with unexpected technological changes. In power systems that suddenly intro-

duce a large penetration of renewables, firms with one set of gas-fired power plants and LTSAs may have to operate their plants in a different regime without a corresponding change to their LTSA portfolio. In this situation, the old LTSA portfolio in combination with the new operating regime will force a firm to accumulate higher operations and maintenance costs that may eventually impact the economic viability of the firm’s gas-fired power plants.

Traditional unit commitment formulations tend to treat operations and maintenance costs abstractly by adding fixed costs to a plant’s unit generation cost. However, the choice of an LTSA clearly can influence a plant owner’s other scheduling, fuel purchase, and generation decisions. In [Rodilla et al., 2014], the authors explicitly model LTSAs in a basic unit commitment problem to compare a system’s cost-minimizing dispatch schedule under both operations and maintenance representations and demonstrate that LTSAs can drastically alter a system’s optimal schedule, particularly in power systems that require their gas fleet to cycle frequently. As electric power systems increasingly integrate renewables, their need for gas-fired power plants to operate with lower load factors and cycle more frequently can lead to substantial and unexpected operations and maintenance costs as a result of existing LTSAs that current unit commitment formulations do not represent.

Firms may be able to operate their power plants more efficiently if they explicitly consider the structure of their LTSAs, and they may be able to renegotiate existing LTSAs given particular expectations about electricity demand and fuel availability in their power system. As part of the individual firm’s strategic decisions, this dissertation explores the firm’s LTSA selection problem under uncertainty in fuel availability and residual electricity demand.

### **Semiannual maintenance scheduling**

As a condition of most LTSAs, generation firms must regularly take their gas-fired power plants offline for maintenance and inspection. These regular inspections allow a manufacturer to evaluate wear and tear and preemptively address mechanical problems. Typically, inspections occur after a plant operates for a predefined number of

firing hours or starts (e.g., every 6000 hours or 50 starts) and last between five and ten days. Notably, this semiannual maintenance is distinct from the major overhaul service that plants must receive at the end of their LTSAs. [Boyce, 2012] In many power systems, firms must declare their plans for scheduled outage and maintenance ahead of time to the system operator, as the removal of capacity can adversely impact electric power system reliability.

Scheduled outages can impact a generation firm's decisions in multiple ways. For example, given a portfolio of gas-fired power plants, if the firm can reasonably estimate its outage schedule, it may be able to commit to long-term gas transportation with more certainty if it knows that a specific fraction of its plants throughout the year will always be offline. Alternatively, if the firm knows that the most advantageous times to take its plants offline are during seasonally low demand periods in the spring and fall and expects that marginal prices will be high enough to keep the entire fleet operational during the summer, then the firm may decide to commit to excess gas transportation to ensure that its entire fleet will have adequate fuel supplies during the high demand months. Scheduled maintenance can also impact the amount of capacity that a firm can commit to a forward capacity market in markets that allow portfolio bids (such as ISO-NE's forward capacity market [Ausubel and Ashcroft, 2007]). Depending on its expectations about future fuel, energy, and capacity prices, a firm may decide to commit more or less capacity and then concentrate or spread out its maintenance to accommodate its capacity commitment. To investigate how a firm's maintenance requirements and scheduled maintenance decisions interact with its other decisions, this dissertation treats the annual maintenance problem as a medium-term decision that the firm must make after it decides its long-term fuel purchases and long-term LTSA decisions.

### **Annual forward capacity market commitments**

In a few power systems with wholesale electricity markets, operators have started to implement markets for "forward capacity" to provide economic incentives for firms to commit to providing power plant capacity in the near future. For example, the New

England forward capacity market operates annually using a reverse-auction mechanism. Firms submit an aggregated price-quantity curve corresponding to how much forward capacity they would like to commit to be available over the next three years at a certain price, and ISO-NE independently decides a quantity threshold that it wants to meet using the forward capacity market. The system operator starts the auction at a high price and decrements the clearing price until supply no longer meets demand. All firms with accepted bids are paid the final clearing price. [Ausubel and Ashcroft, 2007] Although there are many rules governing settlement, broadly, firms with accepted bids must meet their capacity obligation during shortage events and pay penalties for underperforming relative to their obligation. [Morrow, 2013] Forward capacity markets allow system operators to address capacity adequacy concerns in the medium term.

Public agencies and private firms have expressed opposing views about the incentives provided by forward capacity markets. Risk-averse private firms have noted that forward capacity markets tend to not guarantee revenue over a long enough time period to merit a change in their long-term fuel decisions, while public agencies have expressed concern that establishing forward capacity markets with long time obligations is equivalent to establishing new regulation, not a new market signal. This dissertation will explore the relationship between a firm’s forward capacity decisions and its other decisions by modeling the firm’s forward capacity commitment as a medium-term decision that the firm must make after it decides its long-term fuel purchases and long-term LTSA decisions.

### **1.3.2 Dimensionality challenges**

Developing an optimal decision model that encompasses an individual firm’s post-investment long- and short-term decisions poses dimensionality challenges that arise from time couplings, integer decisions, and short-term uncertainties. To make “correct” decisions in the long-term (e.g., decisions that, in expectation/on average given a set of uncertainty scenarios, are optimal), firms must simultaneously consider all timescales. However, for the individual firm’s combined gas-electricity problem, long-

term decisions may take place across years or decades, while short-term decisions occur hourly. Directly tracking hourly dynamics to make long-term decisions leads to well-known dimensionality problems due to the sheer size of the optimization problem’s constraint matrix and the large number of branches to explore due to the vast number of hourly integer decisions.

To address these dimensionality challenges, this dissertation presents a framework to convert the integrated hourly problem into a series of smaller, hierarchical optimization problems that, when recombined, yield optimal long-, medium-, and short-term decisions. The decomposition relies on a state estimation technique, described in [Wogrin et al., 2012], that replaces exact temporal intervals as needed in longer timescale subproblems. In the state estimation technique, instead of considering all 8760 hours in a year for a medium-term decision that takes effect for that entire year, the optimization would analyze the traditional unit commitment problem over a limited set of system states and state transitions. Each state might represent, for example, one specific level of electricity demand and one specific level of renewable generation, and allowed transitions represent actual hour to hour transitions. By collapsing the hourly details into a limited set of representative states, hourly uncertainties and decisions can influence long-term decisions. Conversely, long-term decisions, once made, are reintroduced exogenously into the shorter timeframe subproblems in their original, hourly formulation. This framework allows the optimization to make longer term decisions while considering an approximation of the short term dynamics and allows the optimization’s long-term choices to constrain future decisions in later time stages.

### 1.3.3 Next steps

Thus far, this chapter has briefly reviewed the evolution of electricity and gas systems, presented emerging concerns held by public and private stakeholders, identified key decision makers, advocated for the need to develop a new set of decision support tools for operations and policy analyses, and explained the salient decisions that generation firms must make. The next chapter of this dissertation describes a mod-

eling framework to explore coupled gas-electricity systems and the key interactions between a generation firm's decisions that are important to understanding how gas and electricity systems interact. To conclude this chapter, this section enumerates a series of research questions that frame contemporary concerns for further exploration over the next three chapters.

1. Empirically, current forward capacity markets have not incentivized generation firms to purchase long-term natural gas transportation, despite the fact that purchases of long-term natural gas transportation would explicitly eliminate pipeline scarcity concerns for firms that own gas-fired power plants and forward capacity obligations. To what extent does the forward capacity market influence the generation firm's long-term gas transportation decision? Conversely, if gas were available with certainty, generation firms should willingly offer more capacity into forward capacity markets. To what extent does the uncertainty of fuel supplies influence a firm's forward capacity decision?
2. Shortages of fuel availability occur more frequently than forced outage events. In forward capacity markets with sufficiently large penalties, firms should only offer capacity that they are certain will be available when called upon. If the price offered for capacity is lowered or the penalty for deviating increases, firms should offer forward capacity more conservatively. To what extent does uncertainty about fuel availability, future electricity demand, and the need to perform regular plant maintenance affect a generation firm's forward capacity offer?
3. LTSAs can substantially alter the optimal dispatch schedule of power systems, particularly for systems with a large penetration of intermittent renewables or for systems whose gas-fired power plants experience an operating regime shift from base load to peaker or vice versa. Alternatively, LTSAs may represent an insignificant fraction of a firm's total costs relative to its other costs (for example, relative to the cost of fuel). To what extent does the LTSA that a gas-fired power plant operates under condition its operations, and when should firms attempt to renegotiate their LTSAs?



4. LTSAs and long-term gas prices may influence LTSA contract selection and long-term fuel commitments with respect to encouraging firms to operate their gas-fired power plants as either baseload plants (by committing to long-term fuel and agreeing to an LTSA with a high limit for firing hours) or peaker plants (by not committing to long-term fuel and agreeing to an LTSA with a high limit for starts). As the price of long-term gas decreases, generation firms should increasingly operate their plants as baseload units. How does the firm's long-term gas decision interact with its LTSA decision?

The next chapter explains the mathematical framework developed to explore these research questions, starting with a description of the underlying economic assumptions and a full description of an hourly unit commitment model that incorporates the generation firm's strategic and tactical decisions.

THIS PAGE INTENTIONALLY LEFT BLANK

# Chapter 2

## Combined Gas-Electricity

### Planning & Operation Model

To investigate the individual generation firm's optimal gas and electricity decisions, we start by assuming perfect competition and then propose a mathematical formulation for an equivalent gas-electricity planning problem under a welfare-maximizing central planner. Section 2.1 reviews key economic assumptions about perfect competition, welfare maximization, and cost minimization and explain why these assumptions allow the central planner's welfare-maximizing decisions to also be interpreted as the profit-maximizing decisions of individual firms. The agents in this gas-electricity system consist of one monolithic gas consumer whose gas demand is completely inelastic (e.g., this consumer could represent aggregate gas demand for residential heating); multiple firms that own power plants of varying technologies (e.g., nuclear, coal, and natural gas); and a single large electricity consumer (e.g., a utility representing individual households and small companies). The central planner in this combined gas-electricity model holds the responsibility of making long- and short-term decisions for fuel allocation, maintenance and service, forward capacity, commitment scheduling, and dispatch for all agents.

Analyzing the combined gas-electricity problem from a centrally planned perspective confers several useful benefits. First, the central planner's solution implicitly represents an economically efficient (welfare maximizing) allocation of scarce resources

such as pipeline capacity. Second, solving the central planner’s problem to learn about the optimal behavior of individual firms confers the key advantage of having to solve only one optimization problem—in this case, a mixed integer linear program—instead of having to solve  $G$  simultaneous profit-maximization problems, one for each firm  $g \in G$  in the gas-electricity system. Third, centrally planned models that can be expressed as linear programs and mixed integer linear programs yield dual variables for every constraint that can be usefully interpreted as marginal prices. However, as with many electricity models that span multiple timescales, the dimensionality of the hourly formulation contains practical computational challenges for modern solvers. To enable this formulation to run on modern solvers and computers, at the end of this chapter we reformulate the full hourly problem by decomposing it into a series of smaller problems that can be independently solved and then reintegrated to approximate the decisions of the full hourly model. In its entirety, this chapter proposes theoretical and practical mathematical formulations to investigate the optimal behavior of individual generation firms in gas-electricity systems.

## 2.1 General economic assumptions

In the academic literature for electric power systems, two economic assumptions about perfect competition and welfare maximization/cost minimization underpin the mathematical formulations of almost all central planner models<sup>1</sup>. In this section, we review both assumptions for completeness.

---

<sup>1</sup>As an interesting tangent, and as mentioned in the introduction to this chapter, centrally planned models are also useful because they can frequently be described as linear programs or mixed-integer linear programs whose dual variables contain useful economic information—namely, marginal prices. In electric power systems, a few foundational papers that prove that marginal prices are optimal spot prices and result in welfare maximization and economically efficient decisions include [Mwasinghe, 1981], [Caramanis et al., 1982], [Caramanis, 1982], and [Schweppe, 1987]. However, as [Mwasinghe, 1981] notes, economists had originally developed the link between marginal prices and optimal spot pricing as early as the 1930s, and much of the theoretical background for modern electricity markets finds its roots in advances made in the 1950s (for example, see [Steiner, 1957] and [Boiteux, 1960]). Because electricity happens to be a nearly “perfect” commodity in its homogeneity and physical requirement for constant supply and demand balance, the creation of electricity markets tends to be the first application of much of this earlier literature.

### 2.1.1 Welfare-maximization and cost-minimization

Broadly, the central planner's welfare-maximization problem is defined as producer plus consumer surplus:

$$\max PS + CS \tag{2.1}$$

$$= \max pq - C(q) + V(q) - pq \tag{2.2}$$

$$= \max -C(q) + V(q) \tag{2.3}$$

where producer surplus is the revenue received by generation firms minus their cost, and consumer surplus is the utility that consumers receive minus what they pay. In the formulation above,  $q$  is the quantity of energy,  $p$  is the clearing price,  $C(q)$  is the cost for producers,  $V(q)$  is the utility to consumers. Because the revenues that generation firms receive are exactly the costs paid by consumers, those two terms cancel. If we value every unit of demand equally (for example, at a unit price equal to that of nonserved energy), then  $V(q)$  is fixed, and the central planner's welfare maximization problem (without considering further investment) is analogous to a cost-minimization problem:

$$\max -C(q) + V(q) \rightarrow \min C(q) \tag{2.4}$$

### 2.1.2 Perfect competition

To extract useful information about individual firms from the central planner's problem, we also enforce the assumption of perfect competition so that the central planner's optimal, welfare-maximizing decisions are identical to each individual firm's profit-maximizing decisions. To provide intuition for this result, we briefly review a stylized example of two firms and their profit maximization problems in an electricity market versus the central planner's problem. (For a more formal proof, see Chapter 2 in [Pérez-Arriaga, 2013]). For both scenarios, we will assume that consumers demand a normalized quantity  $q$  of electricity that depends on price  $p$  and takes the following

functional form:

$$q(p) = 1 - p \quad (2.5)$$

Consumers receive utility from consuming quantity  $q$  of electricity equal to the price that they are willing to pay less their total cost (below,  $x$  is placeholder variable for integration):

$$\max_q \int_0^q p(x)dx - (p)(q) \quad (2.6)$$

$$= \max_q \int_0^q (1 - x)dx - pq \quad (2.7)$$

$$= \max_q q - \frac{q^2}{2} - pq \quad (2.8)$$

which yields the following first order condition (FOC) for the consumer's problem after taking the derivative with respect to decision variable  $q$ :

$$\mathcal{L} = q - \frac{q^2}{2} - pq \quad (2.9)$$

$$\text{FOC: } \frac{\partial \mathcal{L}}{\partial q} = 1 - q - p = 0 \quad (2.10)$$

Additionally, in a perfectly competitive market, each generation firm  $i$  takes  $p$  as an exogenous electricity price and optimizes the quantity of electricity that it produces to maximize profits:

$$\max_{x_i} px_i - C_i(x_i) \quad (2.11)$$

where  $px_i$  represents the firm's revenues, and  $C_i(x_i)$  represents the firm's costs. Assume that two firms exist in this market, each with the following marginal cost functions:

$$C_1(x_1) = x_1 \quad (2.12)$$

$$C_2(x_2) = 2x_2 \quad (2.13)$$

Accordingly, firm 1 faces the following explicit profit problem:

$$\max_{x_1} px_1 - \int_0^{x_1} C_1(x) dx \quad (2.14)$$

$$= \max_{x_1} px_1 - \int_0^{x_1} x dx \quad (2.15)$$

$$= \max_{x_1} px_1 - \frac{x_1^2}{2} \quad (2.16)$$

and the first order condition for firm 1 is:

$$\mathcal{L} = px_1 - \frac{x_1^2}{2} \quad (2.17)$$

$$\text{FOC: } \frac{\partial \mathcal{L}}{\partial x_1} = p - x_1 = 0 \quad (2.18)$$

Similarly, firm 2 faces the following profit maximization problem:

$$\max_{x_2} px_2 - \int_0^{x_2} C_2(x) dx \quad (2.19)$$

$$= \max_{x_2} px_2 - \int_0^{x_2} 2x dx \quad (2.20)$$

$$= \max_{x_2} px_2 - 2x_2^2 \quad (2.21)$$

$$\text{FOC: } \frac{\partial \mathcal{L}}{\partial x_2} = p - 2x_2 = 0 \quad (2.22)$$

Solving the consumer utility and firm profit maximization FOCs simultaneously yields

$$x_1^* = \frac{2}{5}, x_2^* = \frac{1}{5}, p^* = \frac{2}{5}, q^* = \frac{3}{5} \quad (2.23)$$

A central planner would approach this problem by maximizing the sum of consumer and producer surplus ( $q', x'_1, x'_2$  are dummy variables for integration):

$$\max_{q, x_1, x_2} \int_0^q (1 - q') dq' - \int_0^{x_1} x'_1 dx'_1 - \int_0^{x_2} 2x'_2 dx'_2 \quad (2.24)$$

$$\text{s.t. } q \leq x_1 + x_2 \quad (2.25)$$

The corresponding Lagrangian and first order conditions are:

$$\mathcal{L} = q - \frac{q^2}{2} - \frac{x_1^2}{2} - 2x_2^2 - \lambda(q - x_1 - x_2) \quad (2.26)$$

$$\frac{\partial \mathcal{L}}{\partial q} = 1 - q - \lambda = 0 \quad (2.27)$$

$$\frac{\partial \mathcal{L}}{\partial x_1} = -x_1 + \lambda = 0 \quad (2.28)$$

$$\frac{\partial \mathcal{L}}{\partial x_2} = -2x_2 + \lambda = 0 \quad (2.29)$$

$$\frac{\partial \mathcal{L}}{\partial \lambda} = q - x_1 - x_2 = 0 \quad (2.30)$$

which are the same FOCs as in the individual profit maximization problems when  $p = \lambda$ . Equating and simplifying the FOCs results in the following identities

$$\lambda = 1 - q = x_1 = 2x_2 \quad (2.31)$$

which yield the same allocation as the individual profit/utility maximizing problems when supply ( $x_1 + x_2$ ) and demand ( $q$ ) are explicitly set equal:

$$\lambda^* = p^* = \frac{2}{5}, x_1^* = \frac{2}{5}, x_2^* = \frac{1}{5}, q^* = \frac{3}{5} \quad (2.32)$$

When  $p = \lambda$ , the solutions to the central planner and the individual consumer and generation firm's problems are identical, and  $p^*, \lambda^*$  represent the optimal  $p$  and  $\lambda$  that maximize welfare. Consequently, by applying assumptions about perfect competition to the central planner's welfare-maximization problem, we can formulate and solve a cost-minimization problem from the central planner's perspective that also yields the profit-maximizing decisions of individual agents in the system.

## 2.2 Full hourly model description

Given the previous economic assumptions for analyzing the individual firm's problem using a centralized planner formulation, this section builds, piece-by-piece, a mathe-



mathematical model of the central planner’s hourly problem across multiple years. Because the resulting mathematical formulation is impractical to solve simultaneously, the next section contains a reformulation of the hourly model separated by timescales into smaller subproblems. However, for illustrative purposes (many of the decision variables are easier to understand without the additional complexity needed to reduce dimensionality), as well as for completeness, this section first presents the central planner’s full hourly gas-electricity problem.

For the remainder of this dissertation, unless otherwise noted, the following indices, parameters, and decision variables are defined as follows:

index	description
$i = 1..I$	indices of all power plants in the system
$nj \in I$	nongas subset of power plants
$j \in I$	gas subset
$t = 1..T$	hourly index
$d = 1..D$	daily index
$p = 1..P$	month index
$a = 1..A$	year index
$k = 1..K$	demand scenarios
$n = 1..N$	fuel transportation scenarios
$v = 1..V$	renewable generation scenarios
$g = 1..G$	individual firms in the system
$l = 1..L$	long-term service agreement alternatives
$h = 1..H_l$	number of planes in LTSA $l$ ’s MIF

The gas-electricity cost-minimization problem has the following parameters:

parameter	description
$\underline{X}_i, \overline{X}_i$	minimum and maximum output levels for plant $i$
$H_i$	heat rate for plant $i$
$FY_i$	fuel required to start plant $i$
$FZ_i$	fuel required to stop plant $i$
$R_i$	maximum up/down ramp rate for plant $i$

(continued from previous page)

parameter	description
$RR_i$	symmetric up/down cycle times for plant $i$
$C_{1,i}$	start-up cost for plant $i$
$C_{2,i}$	shut-down cost for plant $i$
$C_{3,i}$	no-load cost for plant $i$
$C_{4,i}$	cost of fuel for plant $i$
$C_{5,nj}$	maintenance cost adder for plant $nj$
$C_{6,l}$	major overhaul cost for contract $l$
$C_{7,d}$	commodity price of natural gas for day $d$
$C_{8,d}$	transportation price of natural gas for day $d$
$ED_{k,t}$	electricity demand for scenario $k$ , hour $t$
$RG_{v,t}$	renewable generation for scenario $v$ , hour $t$
$GD_{n,d}$	all nonelectric demand for gas in day $d$
$P_{LT,FX}$	unit price of long-term transportation contract
$PC$	pipeline capacity of the gas zonal market
$FH_{A_l,h}$	firing hours limit for LTSA $l$ , plane $h$
$SL_{A_l,h}$	starts limit for LTSA $l$ , plane $h$
$MFH$	firing hours limit before scheduled maintenance
$MST$	starts limit before scheduled maintenance
$MD_j$	maintenance duration for plant $j$
$FCM_a$	forward capacity target for year $a$
$FOR_{nj}$	statistical forced outage rate for plant $nj$
$SH$	set of shortage hours
$P_n$	probability of gas demand scenario
$P_k$	probability of demand scenario $k$
$P_v$	probability of renewable generation scenario $v$

(continued from previous page)

parameter	description
$A_{\min,g}$	long-term transportation target
$\beta_g$	probability target for meeting transportation target
$f_{\text{est.},n,k,v,d,g}$	estimated required daily fuel

And finally, the gas-electricity system problem has the following decisions variables:

endogenous variables	description
$x_{n,k,v,i,t}$	total generation level for power plant $i$
$w_{n,k,v,i,t}$	generation level for power plant $i$ above its min
$y_{n,k,v,i,t}$	start-up decision for plant plant $i$ in hour $t$
$z_{n,k,v,i,t}$	shut-down decision for plant plant $i$ in hour $t$
$u_{n,k,v,i,t}$	commitment state for plant $i$ in hour $t$
$fx_{LT,g}$	long-term gas transportation commitment
$fx_{ST,n,k,v,d,g}$	short-term (daily) gas transportation purchases
$f_{n,k,v,d,g}$	electric power system's daily natural gas usage
$starts_{n,k,v,j}$	total starts for plant $j$
$fh_{n,k,v,j}$	total firing hours for plant $j$
$umd_{n,k,v,t,j}$	product of binary variables (u)(md)
$md_{n,k,v,t,j}$	maintenance state of plant $j$ in hour $t$
$mS_{n,k,v,t,j}$	starts offset to reset accumulator
$mF_{n,k,v,t,j}$	firing hours offset to reset accumulator
$sAcc_{n,k,v,t,j}$	accumulated starts since last maintenance
$hAcc_{n,k,v,t,j}$	accumulated firing hours since last maintenance
$moc_{n,k,v,j}$	maintenance cost for plant $j$
$mc_{j,l}$	binary LTSA decision for plant $j$ , contract $l$
$mb_{n,k,v,t,j}$	binary maintenance start decision

(continued from previous page)

endogenous variable	description
$f^{CC_{MAX,GAS,n,k,v,a,g}}$	capacity commitment from gas units for year $a$
$f^{CC_{MAX,NONGAS,n,k,v,a,g}}$	capacity commitment from nongas units for year $a$
$f^{CC_{J,n,k,v,d,j}}$	daily contribution of gas plant $j$ to fwd. capacity
$f^{CC_{NJ,n,k,v,d,nj}}$	daily contribution of plant $j$ to fwd. capacity
$f^{CC_{n,k,v,a,g}}$	aggregate fwd. capacity commitment from firm $g$
$a_{ST,k,v,n,d,g}$	fraction of daily gas trans. met with spot market
$a_{LT,k,v,n,q,g}$	fraction of gas trans. met with long-term contracts
$a_{\min,g}$	actual frac. of trans. met by long-term contracts
$a_{q,g}$	dummy variable to drive $a_{\min,g}$ to $A_{\min}$

## 2.2.1 Unit commitment with gas transportation

To begin, we build a unit commitment model with fuel constraints for an entire power system. Taking into consideration technical minimums, maximums, and ramp limits, the following formulation describes a basic unit commitment for all of the power plants, regardless of technology, in a single node. Let  $\Omega = [x, w, y, z, u]$  (subscripts removed for brevity); then, for a specific electricity/gas/renewable scenario  $(n, k, v)$ , the central planner solves:

$$\min_{\Omega} \sum_{t,i} \left[ (x_{n,k,v,i,t})(C_{4,i})(H_i) \right. \quad (2.33)$$

$$\left. + (u_{n,k,v,i,t})(C_{i,3}) + (y_{n,k,v,i,t})(C_{i,1}) + (z_{n,k,v,i,t})(C_{i,2}) \right]$$

$$\text{s.t. } \sum_i x_{n,k,v,i,t} = d_{k,t} \forall t \quad \text{demand balance} \quad (2.34)$$

$$x_{n,k,v,i,t} \leq u_{n,k,v,i,t} \overline{X}_i \forall i, t \quad \text{technical max} \quad (2.35)$$

$$x_{n,k,v,i,t} \geq u_{n,k,v,i,t} \underline{X}_i \forall i, t \quad \text{technical min} \quad (2.36)$$

$$u_{n,k,v,i,t} = u_{n,k,v,i,t-1} + y_{n,k,v,i,t} - z_{n,k,v,i,t} \forall i, t \quad \text{commitment state} \quad (2.37)$$

$$x_{n,k,v,i,t} - x_{n,k,v,i,t-1} \leq \overline{R}_i \forall i, t \quad \text{up ramp maximum} \quad (2.38)$$

$$x_{n,k,v,i,t} - x_{n,k,v,i,t-1} \geq -\overline{R}_i \forall i, t \quad \text{down ramp maximum} \quad (2.39)$$

$$y_{n,k,v,i,t}, z_{n,k,v,i,t} \in \{0, 1\} \forall i, t \quad \text{commitment variables} \quad (2.40)$$

$$u_{n,k,v,i,t} \geq \sum_{t-RR_i}^t y_{n,k,v,t,i} \forall t, i \quad \text{minimum up time} \quad (2.41)$$

$$u_{n,k,v,i,t} \geq \sum_{t-RR_i}^t z_{n,k,v,t,i} \forall t, i \quad \text{minimum down time} \quad (2.42)$$

$$x_{n,k,v,i,t}, y_{n,k,v,i,t}, z_{n,k,v,i,t} \geq 0 \quad \text{nonnegative variables} \quad (2.43)$$

$$u_{n,k,v,i,t} \in \{0, 1\} \quad \text{binary variables} \quad (2.44)$$

In the above representation, on each day  $d$ , each firm  $g$  consumes the following share of gas based on its plants' commitment states, dispatch levels, and heat rates:

$$f_{n,k,v,d,g} = \sum_{j \in g, t \in d} \left[ x_{n,k,v,j,t} H_j + y_{n,k,v,j,t} F Y_j + z_{n,k,v,j,t} F Z_j + u_{n,k,v,j,t} F C_j \right] \quad (2.45)$$

and the power system as a whole requires the following quantity of gas over an entire day  $d$ :

$$f_{n,k,v,d} = \sum_g f_{n,k,v,d,g} \quad (2.46)$$

where  $j \in I$  represents the system's gas-fired power plants. In this single-node gas system, the maximum pipeline capacity constrains the power system's total gas consumption, and the power system can ship gas using short-term capacity left over after subtracting the non-electric consumer's natural gas demand from the total pipeline capacity.

On each day, the central planner decides the welfare-maximizing allocation of excess pipeline capacity amongst all gas-fired power plants. As this dissertation seeks to explore the conditions under which a firm might engage in a long-term transportation contract, the central planner can also purchase for each group of gas-fired power plants a daily fixed quantity  $fx_{LT,g}$  of long-term transportation for the entire duration  $T$  that all plants  $j \in g$  can share. This decision is analogous to a firm contracting for

long-term transportation capacity that it cannot sell in a secondary market and that has no value if unused on any given day. Combining the available short-term pipeline capacity and any long-term transportation contracts, the power system's total gas consumption on any given day must respect the following constraints:

$$fx_{ST,n,k,d,g} \geq f_{n,k,v,d,g} - fx_{LT,g} \forall d, g \quad \text{per firm gas transportation} \quad (2.47)$$

$$\sum_g fx_{ST,n,k,d,g} \leq PC - GD_{n,d} \forall d \quad \text{total pipeline capacity} \quad (2.48)$$

This representation of a single-node gas system reflects the reality of many natural gas systems in which local distribution companies and industrial users with more predictable demand than power generation firms tend to own a substantial majority of long-term transportation contracts, and on a short-term basis, these agents release any capacity that they do not need into a secondary market. Combining these gas constraints with the previous unit commitment (Eqs. 2.33-2.44) and modifying Eq. 2.33 to explicitly represent the cost of natural gas yields the following fuel-constrained unit commitment formulation. Let  $\Omega = [x, w, u, y, z, f, fx_{LT,g}, fx_{ST,g}]$  (previous decision variable subscripts omitted for brevity); then:

$$\begin{aligned} \min_{\Omega} \sum_{t,nj} & \left[ (x_{n,k,v,nj,t})(C_{4,nj})(H_{nj}) + (u_{n,k,v,nj,t})(C_{3,nj}) \right. \\ & \left. + (y_{n,k,v,nj,t})(C_{1,nj}) + (z_{n,k,v,nj,t})(C_{2,nj}) \right] \\ + \sum_{t,j} & \left[ (x_{n,k,v,j,t})(H_j)(C_{7,d} + C_{8,d}) + (u_{n,k,v,j,t})(C_{3,j}) \right. \\ & \left. + (y_{n,k,v,j,t})(FY_j) + (z_{n,k,v,j,t})(FZ_j) \right] \\ + T \sum_g & (fx_{LT,g})(P_{LT,FX}) \end{aligned} \quad (2.49)$$

s.t. Eqs. 2.34-2.44 unit commitment

Eqs. 2.45-2.48 gas constraints

## 2.2.2 Long-term service agreement selection

The central planner must decide what type of long-term service agreement (LTSA) to commit its gas-fired power plants to, and the choice of LTSA will define the maintenance interval function (MIF) relating the number of firing hours ( $FH$ ) and starts ( $S$ ) that a gas-fired power plant can accumulate over the duration of its LTSA. For each scenario  $(n, k, v)$ , assuming that the function relating the number of firing hours to the number of allowed starts—frequently referred to as an LTSA’s maintenance interval function (MIF)—is convex, the following constraint allows for a piecewise-linear representation of each MIF (for a full explanation about the underlying mathematical mechanics, see [Rodilla et al., 2014]):

$$\begin{aligned}
& \sum_t u_{n,k,v,j,t} C_{6,l} (FH_{A_{l,h}} - FH_{A_{l,h+1}}) & (2.50) \\
& - \sum_t y_{n,k,v,j,t} C_{6,l} (S_{A_{l,h}} - S_{A_{l,h+1}}) \\
& + moc_{n,k,v,j} (S_{A_{l,h}} FH_{A_{l,h+1}} - S_{A_{l,h+1}} FH_{A_{l,h}}) \\
& \geq M(mc_{j,l} - 1) \forall j, l, h, \mathbb{R} \left( \sum_t y_{n,k,v,j,t}, \sum_t u_{n,k,v,j,t} \right) \in \triangleleft_{A_{l,h}} O_{A_{l,h+1}}
\end{aligned}$$

To limit the central planner to only assigning one LTSA to each gas-fired power plant,

$$\sum_l mc_{j,l} = 1 \forall j \tag{2.51}$$

$$mc_{j,l} \in \{0, 1\} \tag{2.52}$$

where  $mc_{j,l}$  is a special ordered set type one binary variable (for each  $j$ , only one  $mc_{j,l}$  variable can take a value of 1). Eqs. 2.50-2.52 exhaustively define the search space of possible LTSA portfolios. Over the range of allowed firing-hours-to-starts ratios for a given LTSA, the set of constraints above will return a specific maintenance cost  $moc_{n,k,v,j}$  for each gas-fired power plant. To select an optimal LTSA portfolio, the

central planner minimizes its maintenance costs:

$$\min_{mc_{j,t}} \sum_j mOC_{n,k,v,j} \quad (2.53)$$

s.t. Eqs. 2.50-2.52

Combining LTSA selection and maintenance cost into the previous unit commitment with gas transportation yields a mathematical representation of the central planner's long-term fuel purchase and service agreement problems. Let  $\Omega = [x, w, u, y, z, f, fx_{LT,g}, fx_{ST,g}, mc]$ ; then the central planner's long-term problem is as follows:

$$\min_{\Omega} \text{Eq. 2.49} + \text{Eq. 2.53}$$

Eqs. 2.34-2.44 unit commitment

Eqs. 2.45-2.48 pipeline

Eqs. 2.50-2.52 maintenance

### 2.2.3 Maintenance scheduling

Approximately every 6000 firing hours or 200 starts (whichever comes first), owners must mechanically inspect a gas-fired power plant and make repairs. This inspection can take anywhere between two to five days depending on the required work. [Boyce, 2012] As this maintenance takes a gas-fired power plant completely offline and removes its capacity from the electricity market, scheduled maintenance can substantially alter both the gas consumption and the available capacity of a power system. To incorporate considerations for maintenance scheduling, we introduce a new binary variable that indicates when a gas-fired power plant begins maintenance and a new nonnegative variable that tracks the duration of the maintenance (as before, the constraints are shown for a single scenario  $(n, k, v)$ ):

$$mb_{n,k,v,j,t} \in \{0, 1\} \quad (2.54)$$



$$md_{n,k,v,j,t} = \sum_{t-MD_j}^t mb_{n,k,v,j,t} \forall j, t \quad \text{maint. duration} \quad (2.55)$$

In each hour that a gas-fired power plant generates energy, the plant must not be in maintenance and the plant must be committed:

$$md_{n,k,v,j,t} = 0$$

$$u_{n,k,v,j,t} = 1$$

To combine the maintenance variable  $md_{n,k,v,j,t}$  and the commitment variable  $u_{n,k,v,j,t}$  while avoiding multiplying the two variables together (making it possible to still solve this problem as a mixed-integer linear program), we introduce the following constraints that linearize the multiplication of two binary variables<sup>2</sup>:

$$umd_{n,k,v,j,t} \leq u_{n,k,v,i,t} \forall n, k, v, j, t \quad \text{linearization} \quad (2.56)$$

$$umd_{n,k,v,j,t} \leq 1 - md_{n,k,v,i,t} \forall n, k, v, j, t \quad \text{linearization} \quad (2.57)$$

$$umd_{n,k,v,j,t} \geq u_{n,k,v,j,t} - md_{n,k,v,j,t} \forall n, k, v, j, t \quad \text{linearization} \quad (2.58)$$

where  $umd$  represents the product of  $u$  and  $md$  and modify each gas-fired power plant's technical operating limits using the new commitment/maintenance variable:

$$x_{n,k,v,j,t} \leq umd_{n,k,v,j,t} \overline{X}_j \forall n, k, v, j, t \quad \text{tech+maint. max} \quad (2.59)$$

$$x_{n,k,v,j,t} \geq umd_{n,k,v,j,t} \underline{X}_j \forall n, k, v, j, t \quad \text{tech+maint. min} \quad (2.60)$$

As maintenance must take place every  $MFH$  firing hours, we create an accumulator,  $hACC$ , to track the number of firing hours since the last maintenance:

$$hAcc_{n,k,v,j,t}$$

---

<sup>2</sup>This technique is common in linear and mixed integer linear programs when a logical “and” operation is needed between two binary variables. In linear programs, two decision variables usually cannot be multiplied directly because the result is nonlinear (for example, multiplying  $x$  by itself would yield an  $x^2$  term). Using these constraints “linearizes” the multiplication problem, making it possible to multiply binary variables with no loss of generality.

$$= hAcc_{n,k,v,j,t-1} + umd_{n,k,v,j,t} - mF_{n,k,v,j,t} \forall n, k, v, j, t \quad \text{hours acc.} \quad (2.61)$$

$$hAcc_{n,k,v,j,t} \leq MFH \forall n, k, v, j, t \quad \text{hours limit} \quad (2.62)$$

$$mF_{n,k,v,t,j} \leq hAcc_{n,k,v,t-1,j} + umd_{n,k,v,t,j} \forall n, k, v, j, t \quad \text{hours reset} \quad (2.63)$$

$$(M)(mb_{n,k,v,j,t}) \geq mF_{n,k,v,t,j} \forall n, k, v, j, t \quad \text{begin maint.} \quad (2.64)$$

$$\sum_t mb_{n,k,v,j,t} \leq \sum_t umd_{n,k,v,j,t} / MFH + 1 \forall n, k, v, j, t \quad \text{limit maint. cycles} \quad (2.65)$$

where  $mF_{n,k,v,j,t}$  tracks the number of hours that must be subtracted to reset the accumulator after maintenance begins, Eq. 2.64 forces maintenance to begin when the accumulator resets, and Eq. 2.65 limits the number of times that a plant enters maintenance to once every  $MFH$  firing hours.

Every gas-fired power plant has an analogous set of constraints for scheduled maintenance based on its starts threshold,  $MST$ , and its accumulated starts. The variable  $sAcc$  tracks the number of starts accumulated since the last maintenance, and  $mS_{n,k,v,j,t}$  tracks the number of starts that must be subtracted to reset the accumulator after maintenance begins:

$$sAcc_{n,k,v,j,t} = sAcc_{n,k,v,j,t-1} + y_{n,k,v,j,t} - mS_{n,k,v,j,t} \forall n, k, v, j, t \quad \text{starts acc.} \quad (2.66)$$

$$sAcc_{n,k,v,j,t} \leq MST \forall n, k, v, j, t \quad \text{starts limit} \quad (2.67)$$

$$mS_{n,k,v,j,t} \leq sAcc_{n,k,v,j,t-1} + y_{n,k,v,j,t} \forall n, k, v, j, t \quad \text{starts reset} \quad (2.68)$$

$$(M)(mb_{n,k,v,j,t}) \geq mS_{n,k,v,j,t} \forall n, k, v, j, t \quad \text{begin maint.} \quad (2.69)$$

$$\sum_t mb_{n,k,v,j,t} \leq \sum_t y_{n,k,v,j,t} / MST + 1 \forall n, k, v, j, t \quad \text{limit maint. cycles} \quad (2.70)$$

To combine maintenance scheduling into the hourly model developed thus far, we replace the technical maximum and minimum operating constraints as described above and insert the remaining constraints directly into the existing formulation. Let  $\Omega = [x, w, u, y, z, f, fx_{LT,g}, fx_{ST,g}, mc, mb, md, umd, hAcc, mF, sAcc, mS]$ ; then the

central planner’s problem becomes

$$\min_{\Omega} \text{Eq. 2.49} + \text{Eq. 2.53}$$

Eqs. 2.37-2.44	unit commitment
Eqs. 2.45-2.48	gas constraints
Eqs. 2.50-2.52	LTSA selection
Eqs. 2.54-2.70	maintenance scheduling

## 2.2.4 Forward capacity

For each year  $a$  and scenario  $(n, k, v)$ , the system operator operates a forward capacity market that compensates firms in exchange for a guarantee that some fraction of their power plant portfolio will remain available throughout the year to generate electricity. Each firm  $g$  must decide how much capacity,  $fcc_{n,k,v,g,a}$ , to offer into this market from its power plant portfolio. The system operator sets the demand by choosing an arbitrary capacity target,  $FCM_a$ , that may reflect its anticipation of year  $a$ ’s peak demand (or year  $a$ ’s peak demand plus some margin) and clears the market by equating supply and demand:

$$\sum_g fcc_{n,k,v,g,a} = FCM_a \forall a \tag{2.71}$$

To examine the specificities of gas-fired power plants, this formulation separates forward capacity commitments from gas-fired power plants and non-gas-fired power plants. Statistical forced outage rates, maintenance schedules, and fuel constraints reduce the maximum forward capacity that individual power plants can contribute relative to their technical maximum capacities. In this formulation, statistical forced outage rates act as a proxy for the amount of available non-gas-fired capacity. In contrast, and as a distinct departure from traditional literature, this formulation attributes maintenance scheduling and fuel availability as the two primary reasons for reductions in gas-fired power plant capacity instead of using statistical forced outage

rates (Chapter 1 has reviewed in detail the empirical evidence for this assumption). Although unexpected mechanical failures can still occur, given the nature of long-term service agreements and the financial incentives to prevent unexpected mechanical failures, forced outages most likely play a small role in reducing the availability of gas-fired power plants relative to maintenance and fuel availability. In Chapter 3, we describe a post-optimization risk analysis technique based on probabilistic production cost models to evaluate the impact of forced outages.

Given these assumptions, each firm's aggregate forward capacity offer cannot exceed the maximum forward capacity limits of its gas portfolio (denoted by  $f^{CC_{MAX,GAS,a,g}}$ ) and its non-gas portfolio (denoted by  $f^{CC_{MAX,NONGAS,a,g}}$ ):

$$f^{CC_{n,k,v,g,a}} \leq f^{CC_{MAX,NONGAS,n,k,v,a,g}} + f^{CC_{MAX,GAS,n,k,v,a,g}} \quad (2.72)$$

To meet its capacity obligation, each firm must assign individual power plants to cover  $f^{CC_{n,k,v,g,a}}$  on a daily basis. Dependent on maintenance schedules, projected fuel costs, and projected fuel availability, firms may need to use a different set of power plants from day to day to meet their commitment or may need to reduce the total amount of forward capacity offered. For a firm's non-gas-fired power plants, on any given day  $d$  in year  $a$ , plant  $nj$  can contribute capacity  $f^{CC_{NJ,n,k,v,d,nj}}$  up to its derated technical maximum

$$f^{CC_{NJ,n,k,v,d,nj}} \leq (\overline{X_{nj}})(FOR_{nj}) \forall d, nj \quad (2.73)$$

where  $FOR_{nj}$  represents plant  $nj$ 's forced outage rate. From its portfolio of non-gas-fired power plants, the firm, at most, can only commit the amount of capacity that is available in its worst (least capacity available) day of the year:

$$f^{CC_{MAX,NONGAS,n,k,v,g,a}} \leq \sum_{nj} f^{CC_{NJ,d,nj}} \forall d \in a, a, g \quad (2.74)$$

For gas-fired power plants, firms assign each plant  $j$  a forward capacity commitment ( $f^{CC_{J,n,k,v,d,j}}$ ) on a daily basis subject to that plant's technical maximum capacity

$(\overline{X}_j)$  and scheduled maintenance availability ( $md_{n,k,v,d,j}$ ):

$$fcc_{J,n,k,v,d,j} \leq (\overline{X}_j)(1 - md_{n,k,v,d,j}) \forall d \in p, p, j \quad (2.75)$$

As before, in aggregate, the firm at most can only commit from its portfolio of gas-fired power plants the amount of capacity that is available in its worst (least capacity available) day of the year:

$$fcc_{MAX,GAS,g,a} \leq \sum_j fcc_{J,d,j} \forall d \in a, a, g \quad (2.76)$$

Additionally, the firm's gas-fired capacity offer is subject to fuel availability during shortage events:

$$\sum_{j,t \in SH} (fcc_{J,n,k,v,d,j})(H_j) \leq fx_{LT,g} + fx_{ST,n,k,v,g,d} \forall t \in d, d \in a, a, g \quad (2.77)$$

Taking all of these physical constraints into consideration, the system operator makes forward capacity assignments to each firm based on the costs of calling that capacity during shortage events. This formulation uses fuel costs as a proxy to evaluate the future cost of calling on forward capacity:

$$\min \sum_{nj,t \in SH} (fcc_{NJ,n,k,v,d,nj})(H_{nj})(C_{4,nj}) + \sum_{j,t \in SH} (fcc_{J,n,k,v,t \in d,j})(H_j)(C_{7,t \in d}) \quad (2.78)$$

Combining all of the previous decisions with this forward capacity market formulation results in the following problem for the centralized planner. Let

$$\begin{aligned} \Omega = [x, w, u, y, z, f, fx_{LT,g}, fx_{ST,g}, \\ mc, mb, md, umd, hAcc, mF, sAcc, mS \\ fcc_{GAS}, fcc_{NONGAS}, fcc_J, fcc_{NJ}]; \end{aligned}$$

then, the central planner solves:

$$\begin{aligned}
 & \min_{\Omega} \text{Eq. 2.49} + \text{Eq. 2.53} + \text{Eq. 2.78} \\
 & \text{Eqs. 2.37-2.44} \qquad \qquad \qquad \text{unit commitment} \\
 & \text{Eqs. 2.45-2.48} \qquad \qquad \qquad \text{gas constraints} \\
 & \text{Eqs. 2.50-2.52} \qquad \qquad \qquad \text{LTSA selection} \\
 & \text{Eqs. 2.54-2.70} \qquad \qquad \qquad \text{maintenance scheduling} \\
 & \text{Eqs. 2.72-2.77} \qquad \qquad \qquad \text{forward capacity}
 \end{aligned}$$

## 2.2.5 Considerations for uncertainty

Throughout the development of the hourly model, all medium- and short-term decisions have been written with subscripts  $k, n,$  and  $v$  to indicate different potential scenarios for electricity demand, fuel transportation availability, and renewable generation. Assuming independence, each electricity demand scenario occurs with probability  $P_k$ ; each fuel transportation scenario occurs with probability  $P_n$ ; and each renewable scenario occurs with probability  $P_v$ . To determine the optimal gas-electricity decisions in expectation over a set of discrete scenarios, we can solve the deterministic equivalent problem:

$$\begin{aligned}
 & \min_{\Omega} \sum_{k,n,v} (P_k P_n P_v) (\text{Eq. 2.49} + \text{Eq. 2.53} + \text{Eq. 2.78}) \\
 & \text{s.t. Eqs. 2.37-2.44} \qquad \qquad \qquad \text{unit commitment} \\
 & \text{Eqs. 2.45-2.48} \qquad \qquad \qquad \text{gas constraints} \\
 & \text{Eqs. 2.50-2.52} \qquad \qquad \qquad \text{LTSA selection} \\
 & \text{Eqs. 2.54-2.70} \qquad \qquad \qquad \text{maintenance scheduling} \\
 & \text{Eqs. 2.72-2.77} \qquad \qquad \qquad \text{forward capacity}
 \end{aligned} \tag{2.79}$$

## Risk aversion to pipeline capacity shortages

Using this deterministic equivalent problem, we can now incorporate risk aversion on the part of individual firms to the possibility of not being able to acquire enough gas in the short-term. To model risk aversion, we introduce the following set of conditional-value-at-risk constraints that will allow us to specify an arbitrary probability,  $\beta_g$ , that each firm should be able to cover an arbitrary fraction,  $A_{\min,g}$ , of its transportation needs on a daily basis using long-term contracts. [Dueñas et al., 2014] First, we calculate the daily percentage of gas transportation that each firm meets using short-term spot markets as follows:

$$a_{\text{ST},k,v,n,d,g} \geq 1 - \frac{f x_{\text{LT},g}}{f_{\text{est.},k,v,n,d,g}} \forall k, v, n, g, d \quad (2.80)$$

where  $a_{\text{ST},k,n,v,d,g}$  represents the percentage of gas transportation on day  $d$  that firm  $g$  purchases in the spot market. Aggregating  $a_{\text{ST},k,n,v,d,g}$ , we can calculate the average percentage of transportation met using firm transportation,  $a_{\text{LT},k,n,v,g}$ , as follows:

$$a_{\text{LT},k,n,v,g} = 1 - \sum_d \frac{a_{\text{ST},k,n,v,d,g}}{D} \forall k, n, v, g \quad (2.81)$$

Finally, we can require with probability  $\beta_g$  that each firm cover an arbitrary fraction  $A_{\min}$  of its daily gas transportation using firm transportation by adding the following constraints:

$$a_{\min,g} - \sum_q \frac{(P_q)(a_{k,n,v,g})}{1 - \beta_g} \geq A_{\min,g} \forall k, n, v, g \quad (2.82)$$

$$a_{k,n,v,g} \geq a_{\min,g} - a_{\text{LT},k,n,v,g} \forall k, n, v, g \quad (2.83)$$

where  $a_{\min,g}$  represents the actual minimum fraction of a firm's transportation requirements met using long-term contracts. To satisfy Equations 2.82 and 2.83, the optimization must find a long-term transportation quantity for each firm that drives  $a_{q,g}$  to zero and forces the actual minimum fraction of gas transportation covered using long-term contracts to match the average fraction of daily gas transportation

met via long-term contracts.

### Nonanticipativity

Computational challenges aside, if all possible electricity, gas, and renewable scenarios are known (or have known distributions), then the space of all possible scenarios  $(n, k, v)$  can be sampled and a set of decisions for the long-term (regarding long-term fuel transportation and maintenance contracts) can be optimally selected without any changes (because only one decision can be made for  $fx_{LT}$  and  $mc_{j,l}$  across all potential scenarios). Medium-term decisions for forward capacity and maintenance scheduling that will take effect over the next year  $a$  can be optimally selected across all scenarios by adding the following nonanticipativity constraints to force all decisions across unknown scenarios to be the same:

$$fcc_{NA,a,g} = fcc_{n,k,v,a,g} \forall n, k, v, g \quad (2.84)$$

$$fcc_{GAS,NA,a,g} = fcc_{GAS,n,k,v,a,g} \forall n, k, v, g \quad (2.85)$$

$$fcc_{NONGAS,NA,a,g} = fcc_{NONGAS,n,k,v,a,g} \forall n, k, v, g \quad (2.86)$$

$$mb_{n,k,v,t,j} = mb_{NA,n,k,v,t,j} \forall n, k, v, t, j \quad (2.87)$$

$$md_{n,k,v,t,j} = md_{NA,n,k,v,t,j} \forall n, k, v, t, j \quad (2.88)$$

The minimization problem described by the set of Equations in 2.79, along with Equations 2.80-2.83 to model risk aversion to pipeline capacity shortages and Equations 2.84-2.88 to enforce nonanticipativity, represent the central planner's full hourly stochastic problem.

## 2.3 Dimensionality reduction

The model presented in (2.79) makes long- and medium-term decisions for fuel acquisition ( $fx_{LT,g}$ ), forward capacity assignment ( $fcc_{g,a}$ ), maintenance contract selection ( $mc_{j,l}$ ), and maintenance scheduling ( $mb_{n,k,v,t,j}$ ,  $md_{n,k,v,t,j}$ ) by explicitly solving a fuel-constrained hourly unit commitment. However, the hourly combined gas-electricity



problem described thus far is computationally intractable for a real-sized power system over a realistic time horizon of multiple years and a reasonable set of uncertainty scenarios that describe potential electricity demand, renewable generation, and natural gas consumption. The need to consider hourly demand, renewable generation levels, and daily fuel prices for years in conjunction with binary decisions for unit commitment and plant maintenance leads quickly to a tremendous search space.

As an example of the size of the search space, consider the following. Each hour of the problem described in (2.79) contains  $I$  plants to make binary commitment decisions for, as well as  $N$  total fuel availability scenarios,  $K$  total electricity demand scenarios,  $V$  renewable generation scenarios, and  $T$  total hours. Ignoring the contract and scheduling decisions related to maintenance, the number of individual linear programs to consider for the central planner's problem grows in the following manner:

$$(2^I)(T)(N)(K)(V) \tag{2.89}$$

In a real-sized power system with 200 power plants (for example, in its 2013 winter seasonal availability report, ISO-NE listed 204 dispatchable plants), considering only  $N = 2$  fuel transportation scenarios (in any given day, short-term transportation is either available or not) and  $K = 10$  demand scenarios in a system with no renewables ( $V = 1$ ), the search space for the yearly commitment problem grows to

$$(2^I)(T)(N)(K)(V) \tag{2.90}$$

$$= (2^{200})(8760)(2)(10)(1) \tag{2.91}$$

$$\approx 3e65 \text{ scenarios} \tag{2.92}$$

Because long- and medium-term decisions take effect across multiple years during which they will directly impact the hourly decisions that the central planner can make, and because making optimal long- and medium-term decisions requires taking hourly details into consideration, the central planner's problem cannot be decoupled in time to reduce the size of the search space (i.e., all timescales must be considered

simultaneously). As the central planner’s problem covers longer time horizons and more scenarios,  $T$ ,  $N$ ,  $K$ , and  $V$  increase the search space linearly, while additional power plants and new LTSAs will increase the search space of the long-term problem exponentially via  $I$  and  $L$ . In reality, modern solvers will only search a subset of all possible binary decisions. For example, if the price of long-term transportation substantially exceeds the short-term price such that all plants will frequently cycle, the branch-and-bound algorithm may be able to quickly eliminate from consideration many branches in which plants are assigned to less flexible maintenance contracts. However, as the number of uncertainty scenarios and binary decisions increase, a straight-forward hourly formulation of the unit commitment problem across multiple years still results in an intractably large search space.

To make the combined gas-electricity problem tractable, we decompose the formulation in (2.79) into three subproblems separated by timescales. Subproblem (1) solves for the optimal set of long-term fuel contracts and long-term maintenance contracts; subproblem (2) solves for the optimal set of annual forward capacity commitments and the annual maintenance schedule; and subproblem (3) solves a fuel-constrained hourly unit commitment. Instead of sequentially solving subproblems (1) and (2) on an hourly basis, to work around the dimensionality challenges, we reformulate the larger combined gas-electricity problem using the system states approach explained in [Wogrin et al., 2013]. While the system states approach reduces data resolution, solving the combined gas-electricity problem over system states instead of sequential hours confers key computational advantages: once decisions are solved for every possible state and state transition, determining key quantities such as fuel generation and total firing hours requires a simple series of arithmetic operations. To reintegrate long-, medium-, and short-term decisions after decomposing the hourly combined problem into three decision stages, we reintroduce the solutions from subproblems (1) and (2) as exogenous parameters in the following manner:

1. Calculate the optimal long-term decisions for fuel transportation and maintenance contract selection in expectation over the range of forecasted scenarios and probabilities by solving the system state approximation of the model in

(2.79) on a monthly basis.

2. Fix the long-term decisions from the previous step and reintroduce them into (2.79) as exogenous parameters.
3. Re-solve the system state approximation of (2.79) and calculate the medium-term decisions for maintenance scheduling and forward capacity assignment over the range of forecasted scenarios on a weekly basis for the next year; require nonanticipativity for  $mb_{n,k,v,t,j}$ ,  $md_{n,k,v,t,j}$ ,  $fcc_{n,k,v,a,g}$ ,  $fcc_{NONGAS,n,k,v,a,g}$  and  $fcc_{GAS,n,k,v,a,g}$ .
4. Fix all long- and medium-term decisions from the previous steps and introduce their optimal values as exogenous parameters into (2.79); re-solve to determine the optimal short-term unit commitment and scheduling decisions for the next day.

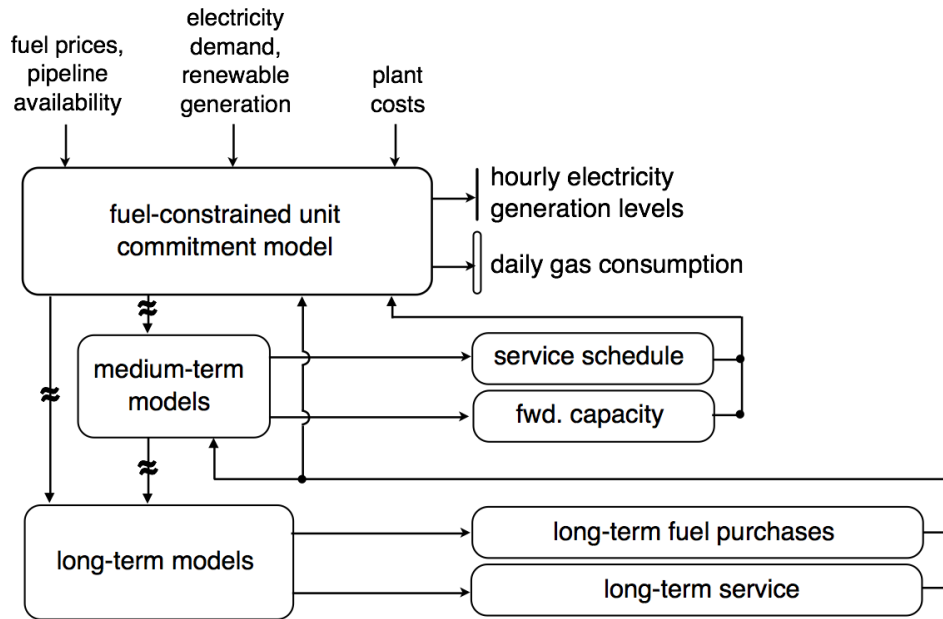

Figure 2-1: Block diagram of feedback between long-, medium- and short-term decisions

Figure 2-1 illustrates how information moves between timescales based on the enumerated steps above and the mathematical model presented in (2.79). Short timescale dynamics are approximated in long- and medium-term decisions, and long- and medium-

term decisions impact shorter timescale models in one of two ways. First, if the value of a larger timescale decision cannot be changed by decisions in the short term, then their contribution to the objective function is constant and ignored by the optimization. This occurs automatically once the decision is exogenously fixed. For example, this is the case with take-or-pay transportation contracts. Regardless of how much gas the owner of a gas-fired power plant consumes on any given day, the cost of the transportation contract is sunk, and the firm must pay for the amount of transportation that it had committed to. Second, the longer term decisions condition the shorter-term actions that the firm can take. For example, in the case of a take-or-pay transportation contract, although the cost of the contract (the amount that the firm owes each day) is constant in the objective function, the take-or-pay commitment also increases the firm’s access to gas transportation by a specific amount of guaranteed pipeline capacity. By decomposing the combined gas-electricity problem into subproblems, approximating shorter-term dynamics for longer term decisions, and iteratively reintroducing strategic decisions as exogenous parameters to shorter timescale problems, we can computationally solve the central planner’s combined gas-electricity problem over a wide range of timescales and scenarios as a proxy for solving the full hourly formulation.

### **2.3.1 System state representation**

To solve the combined gas-electricity problem across a range of timescales, we reformulate the hourly problem using the system states approach pioneered by [Wogrin et al., 2013]. In this section, we briefly summarize the approach using a highly stylized unit commitment as an example; then, in section 2.3.2, we explain in detail the reformulation of the central planner’s combined gas-electricity problem.

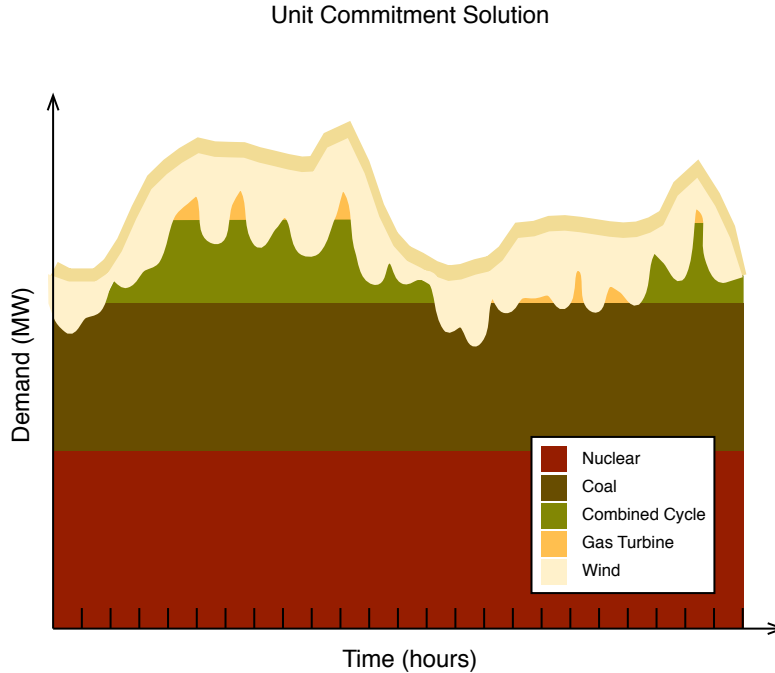

Figure 2-2: Stylized unit commitment results

Figure 2-2 depicts a daily demand curve with the least-cost dispatch solution for a power system that has nuclear, coal, combined-cycle gas turbine, single-cycle gas turbine, and wind generators. To obtain this solution using an hourly unit commitment, the MILP solver analyzes potential commitment states for each plant and explicitly considers every transition between hour  $t$  and hour  $t + 1$ . In the system state approach, instead of analyzing the problem sequentially from one hour to the next, groups similar hours together.

System states can consist of many attributes, not just electricity demand and renewable generation; for example, other useful attributes for the central planner's gas-electricity problem might include daily available gas pipeline capacity or the daily commodity price of gas. In this implementation, a  $k$ -means clustering algorithm creates  $k$  states amongst the selected attributes that minimize the aggregate least-squared error between the system's attributes in every hour and the nearest (most similar) state. Figure 2-3 identifies example states based on the system's electricity demand and wind generation levels, and Figure 2-4 illustrates a completed mapping between hours and system states. For the stylized unit commitment example,  $k = 4$ ,

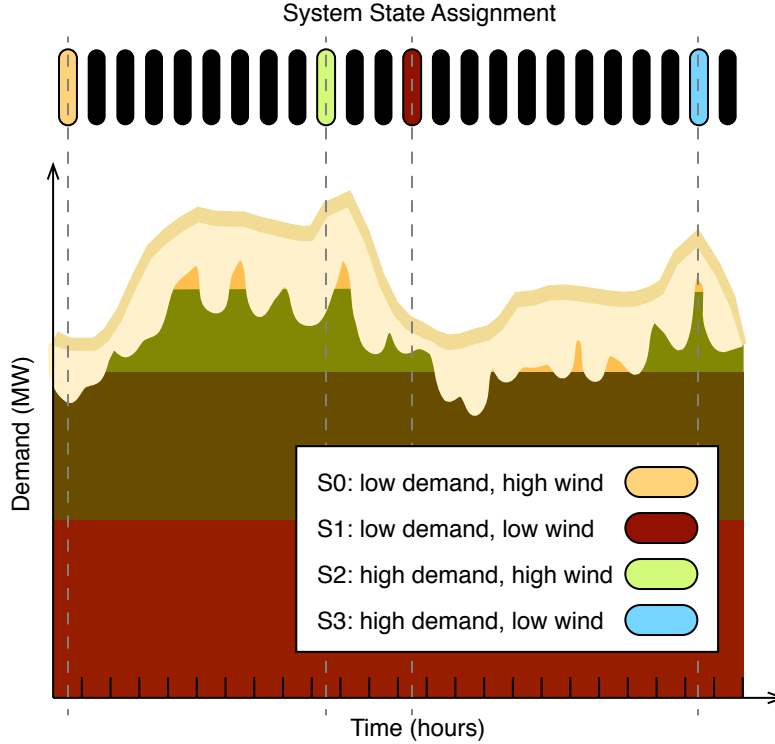

Figure 2-3: Identifying system states using  $k$ -means clustering

and each state contains one level of electricity demand and one level of renewable generation (generically described as “low” and “high” in both figures).

To preserve the dynamic hourly trends after mapping each hour to a state, the system state technique counts the time (number of hours) spent in each state and the number of transitions between states. This representation, shown in Figure 2-5, replaces the traditional hourly formulation in two manners. First, a new state-based decision replaces all decisions that have a time index. For example, if  $x_{j,t}$  represents the dispatch level of plant  $j$  in hour  $t$ , then in the system state reformulation,  $x_{j,t}$  becomes  $x_{j,s}$  where  $s$  denotes one of the states created by the  $k$ -means clustering. In the case of the first hour of this example system, the corresponding dispatch decision for plant  $j$  becomes  $x_{j,s=S0}$ . Second, a new state-to-state decision replaces all decisions that link a previous hour to the next hour. For example, the start-up variable  $y_{j,s=S0,s'=S1}$  represents the start decision for plant  $j$  in every hour where the system exists in state  $S0$  at time  $t$  and transitions to state  $S1$  at time  $t + 1$ , as in the first and second hours (see Figure 2-4). Grouping similar hours together and

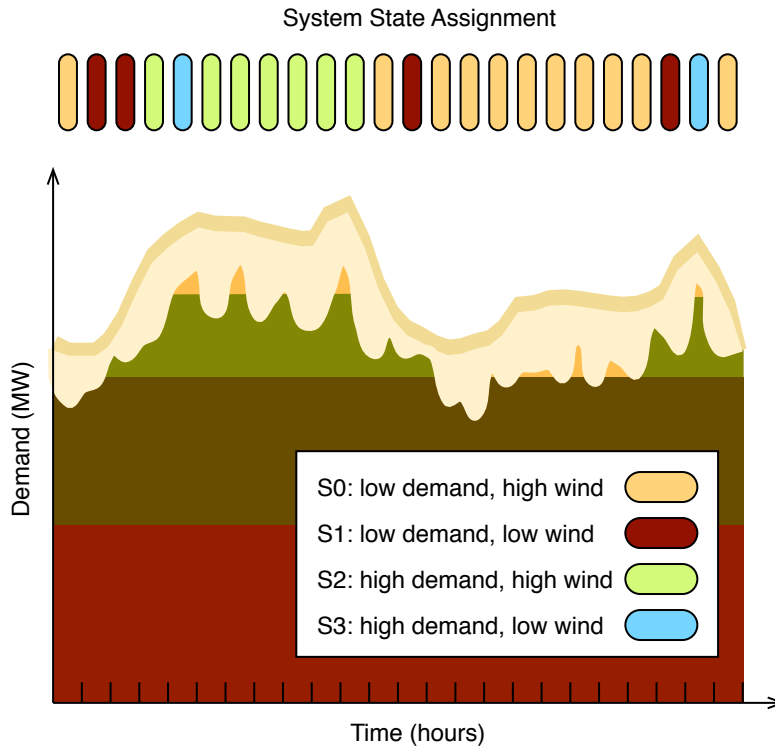

Figure 2-4: Each hour is assigned to the most similar cluster

reformulating the hourly problem using these two techniques yields a new optimization problem with substantially fewer decision variables. For every time period  $p$ , such as a week or a month, the solver determines the least-cost commitment and dispatch for the transitions that occur between states and the system's duration in every state over period  $p$ . Then, the solution to the reformulated problem yields estimates of important quantities such as the number of plant starts, plant stops, and fuel consumption by arithmetically scaling each state-based decision. As each hour must be assigned to one of a discrete set of states, and within each state the attributes of interest have values that are fixed by  $k$ -means clustering, solving the unit commitment over system state durations and transitions instead of sequentially from hour to hour necessarily trades off accuracy in exchange for computationally tractability; for more details and a case study of how the system state approximation compares to solving a traditional hourly unit commitment, see [Wogrin et al., 2013].

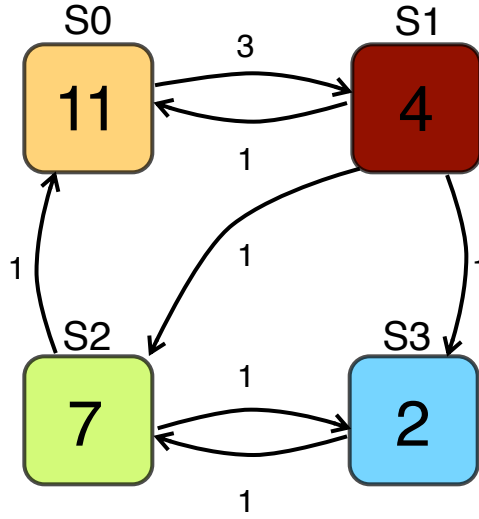

Figure 2-5: Tracking hourly trends and dynamics

### 2.3.2 System state implementation

To study the central planner’s combined gas-electricity problem, in this implementation of the system state approximation, each system state  $s$  contains an electricity demand quantity  $ED_s$  and a renewable generation quantity  $RG_s$ . System states are determined using  $k$ -means clustering over the set of possible electricity demand and renewable generation pairs  $(ED_s, RG_s)$  for each scenario. For long-term decisions, each period  $p$  represents one month. For medium-term, annual decisions, each period represents one week. Within each period and scenario, the electricity demand for electricity scenario  $k$  in  $p$  is described by state  $s$  and a corresponding number of hours  $SDM_{k,p,s}$ . Within the same period and electricity scenario,  $STM_{k,p,s,s'}$  captures the number of transitions that occur from state  $s$  to  $s'$ .

The following tables contain the new and updated variables required to solve the combined gas-electricity day-ahead problem using system states. For brevity, let  $q = \{k, n, v\}$  so that  $q$  now represents a scenario index for a specific combination of electricity ( $k$ ), gas availability ( $n$ ), and renewable generation ( $v$ ) scenarios. First, the system states representation has the following new indices:

index	description
$p$	period index; for example, one week or one month



(continued from previous page)

index	description
$s, s'$	system states index

Second, the system states representation has the following new parameters:

index	description
$SDD_{q,d,s}$	number of hours spent in state $s$ on day $d$
$SDM_{q,p,s}$	number of hours spent in state $s$ in period $p$
$STM_{q,p,s,s'}$	number of transitions from state $s$ to $s'$ in period $p$

And third, the system states representation has the following updated decisions:

endogenous variable	description
$x_{q,s,p,i}$	generation level for plant $i$
$w_{q,s,p,i}$	generation level above min for plant $i$
$y_{q,s,s',p,i}$	plant $i$ 's start-up decision from state $s$ to $s'$
$z_{q,s,s',p,i}$	plant $i$ 's shut-down decision from state $s$ to $s'$
$u_{q,s,p,i}$	plant $i$ 's commitment for state $s$ in period $p$
$fx_{LT,g}$	long-term gas transportation commitment
$fx_{ST,q,d,g}$	short-term (daily) gas transportation purchase
$f_{q,d,g}$	electric power system's daily natural gas usage
$s_{q,j}$	total starts for plant $j$
$fh_{q,j}$	total firing hours for plant $j$
$umd_{q,s,p,j}$	binary product of (u)(md)
$md_{q,p,j}$	maintenance duration
$mS_{q,p,j}$	starts offset to reset accumulator
$mF_{q,p,j}$	hours offset to reset accumulator
$sAcc_{q,p,j}$	accumulated starts since last maintenance
$hAcc_{q,p,j}$	accumulated firing hours since last maintenance

(continued from previous page)

endogenous variable	description
$moc_{q,v,j}$	maintenance cost for plant $j$
$mc_j$	maintenance contract selection for plant $j$
$mb_{q,p,j}$	maintenance start for plant $j$
$fcc_{MAX,GAS,q,a,g}$	max. fwd. cap. contribution from gas
$fcc_{MAX,NONGAS,q,a,g}$	max. fwd. cap. contribution from other tech.
$fcc_{J,q,d,j}$	daily contribution of gas plant $j$ to fwd. cap.
$fcc_{NJ,q,d,nj}$	daily contribution of nongas plant $nj$ to fwd. cap.
$fcc_{q,a,g}$	anticipative fwd. cap. commitment for firm $g$
$fcc_{GAS,NA,a,g}$	nonanticipative fwd. cap. decision
$fcc_{J,NA,d,j}$	nonanticipative fwd. cap. decision
$fcc_{NA,a,g}$	nonanticipative fwd. cap. decision

The reformulated combined gas-electricity problem based on system states is as follows, separated into subsections for clarity.

## Objective function

$$\begin{aligned}
\min \sum_q P_q \left[ \sum_{d,g} f_{q,d,g} C_{7,d} \right. \\
+ \sum_{s,p,nj} (x_{q,s,p,nj}) ((C_{4,nj})(HR_{nj}) + (C_{5,nj}))(SDM_{q,p,s}) \\
+ \sum_{s,p,i} (u_{q,s,p,i})(C_{3,i})(SDM_{q,p,s}) \\
+ \sum_{s,s',p,i} (STM_{q,p,s,s'})(y_{q,s,s',p,i})(C_{1,i}) \\
+ \sum_{s,s',p,i} (STM_{q,p,s,s'})(z_{q,s,s',p,i})(C_{2,i}) \\
+ \sum_j moc_{q,j} \left. \right] \\
+ (P_{FX,LT}) \left( \sum_g fx_{LT,g} \right) (D)
\end{aligned} \tag{2.93}$$

The reformulation changes the objective function more than any other part of the linear program. In order by line, the objective function sums the cost of (1) natural gas consumption by gas-fired generators; (2) generation costs for all non-gas fired power plants including a cost adder for operations and maintenance; (3) commitment costs for all plants; (4) start up costs for all plants; (5) shut down cost for all plants; (6) maintenance costs attributed to long-term service agreements for gas-fired power plants; and (7) long-term transportation commitments.

The summations above illustrate how the system state approach arithmetically estimates costs without sequentially solving over all hours. As an example, consider the generation variable,  $x_{q,s,p,nj}$ , and the summation in the second line of the objective function. To determine the cost of generation for non-gas fired power plants, the objective function calculates a unit cost for generation based on each plant's heat rate,  $HR_{nj}$ , fuel cost,  $C_{4,nj}$ , and maintenance adder,  $C_{5,nj}$ . Then, the objective function scales this unit cost based on plant  $nj$ 's actual output,  $x_{q,s,p,nj}$ , and the number of hours,  $SDM_{q,p,s}$ , that the system exists in state  $s$  for period  $p$  and scenario  $q$ . After re-

peating this summation across all states, time periods, and non-gas fired power plants in the system, the objective function has a single aggregate cost that represents the cost of generation for all non-gas fired power plants. The objective function tracks costs for the other state- and state-transition-based variables in a similar manner, by first establishing a unit cost (typically copied directly from the original objective function) and then scaling by either the state duration or the number of state transitions.

### Unit commitment constraints

$$\text{s.t. } \sum_i x_{q,s,p,i} = ED_{q,s} - R_{q,s} \forall q, s, p \quad \text{demand bal.} \quad (2.94)$$

$$x_{q,s,p,j} = w_{q,s,p,j} + (umd_{q,s,p,j})(X_{nj,\min}) \forall q, s, p, j \quad \text{total output} \quad (2.95)$$

$$x_{q,s,p,nj} \geq (u_{q,s,p,nj})(X_{nj,\max}) \forall q, s, p, nj \quad \text{tech. max} \quad (2.96)$$

$$x_{q,s,p,nj} \leq (u_{q,s,p,i})(X_{nj,\min}) \forall q, s, p, nj \quad \text{tech. min} \quad (2.97)$$

$$x_{q,s,p,j} \geq (umd_{q,p,j})(X_{j,\max}) \forall q, s, p, j \quad \text{maint. max} \quad (2.98)$$

$$x_{q,s,p,j} \leq (umd_{q,p,j})(X_{j,\min}) \forall q, s, p, j \quad \text{maint. min} \quad (2.99)$$

$$u_{q,s,s',p,i} = u_{q,s,p,i} + y_{q,s,s',p,i} - z_{q,s,s',p,i} \forall q, p, s, s', i \quad \text{commitment} \quad (2.100)$$

$$y_{q,s,s',p,i} \leq 1 \forall q, s, s', p, i \quad \text{starts} \quad (2.101)$$

$$z_{q,s,s',p,i} \leq 1 \forall q, s, s', p, i \quad \text{stops} \quad (2.102)$$

The unit commitment constraints largely resemble their hourly counterparts, with exception to the demand balance equation (Eq. 2.94) and the calculation of the commitment state variable (Eq. 2.100). As part of the system state approximation, state demand and renewable generation “bins” replaced hourly demand and renewable generation levels. Consequently, the demand balance constraint is only enforced for all possible states. As in the original hourly formulation, power plants in this system only need to meet the net demand that remains after subtracting the state renewable generation level,  $R_{s,q}$ , from the state electricity demand level,  $ED_{s,q}$ . Lastly, the reformulated commitment now calculates plant commitment decisions over all possible

state transitions from  $s$  to  $s'$ , and not from hour  $t - 1$  to  $t$ . These modifications to the unit commitment constraints substantially reduce the computational effort required to find a solution to the central planner's long- and medium-term problems.

### Natural gas constraints

$$f_{q,d \in p,g} = \sum_{j \in g,s} (x_{q,s,p,j})(HR_j)(SDD_{q,d,s}) \forall q, d, p, g \quad \text{daily gas usage} \quad (2.103)$$

$$f_{q,d,g} \leq fx_{ST,q,d,g} + fx_{LT,g} \forall q, d, g \quad \text{daily transportation} \quad (2.104)$$

$$\sum_g fx_{ST,q,d,g} \leq PC - GD_{n,d} \forall q, d \quad \text{pipeline capacity} \quad (2.105)$$

Natural gas constraints for the reformulated problem appear as direct translations of the original hourly formulation, with state-based variables replacing hourly variables. As in the objective function, the natural gas constraint scales generation decisions  $x_{q,s,p,j}$  by their daily duration,  $SDD_{q,d,s}$ , to estimate the power system's daily fuel consumption. Notably, for gas, both the long- and medium-term problems estimate fuel usage and enforce fuel pipeline constraints on a daily basis because pipeline capacity can substantially change within the same month or week based on nonelectric demand for natural gas.

### LTSA selection

$$fh_{q,j} = \sum_{p,s} (umd_{q,s,p,j})(SDM_{q,p,s}) \quad \text{total firing hours} \quad (2.106)$$

$$s_{q,j} = \sum_{p,s,s'} (y_{q,s,s',p,j})(STM_{k,p,s,s'}) \quad \text{total starts} \quad (2.107)$$

$$\begin{aligned} & (s_{q,j})(C_{6,l})(FH_{A_{l,h}} - FH_{A_{l,h+1}}) \\ & - (fh_{q,j})(C_{6,l})(S_{A_{l,h}} - S_{A_{l,h+1}}) \\ & + (moc_{q,v,j})(S_{A_{l,h}} FH_{A_{l,h+1}} - S_{A_{l,h+1}} FH_{A_{l,h}}) \\ & \geq M(mc_{j,l} - 1) \forall j, l, h, \mathbb{R}(s_{q,j}, fh_{q,j}) \in \triangleleft_{A_{l,h}} O A_{l,h+1} \end{aligned} \quad \text{MIF cost} \quad (2.108)$$

$$\sum_l mc_{j,l} = 1 \forall j \quad \text{contract selection} \quad (2.109)$$

As with natural gas constraints, maintenance constraints also appear as direct translations of the original hourly formulations. To count a plant's firing hours, the reformulation scales the commitment variable  $umd_{q,s,p,j}$  by the duration parameter,  $SDM_{q,p,s}$ , and then sums all periods together. The same operation estimates total plant starts using start decision  $y_{q,s',p,j}$  and transition count  $STM_{k,p,s,s'}$ .

### Maintenance scheduling, binary constraints

$$umd_{q,s,p,j} \leq u_{q,s,p,j} \forall q, s, p, j \quad \text{linearization} \quad (2.110)$$

$$umd_{q,s,p,j} \leq 1 - md_{q,p,j} \forall q, s, p, j \quad \text{linearization} \quad (2.111)$$

$$umd_{q,s,p,j} \geq u_{q,s,p,j} - md_{q,p,j} \quad \text{linearization} \quad (2.112)$$

The maintenance scheduling binary constraints directly map from their hourly variables to their state-based variables, and the same linearization technique allows the multiplication of the binary variables for commitment,  $u_{q,s,p,j}$ , and maintenance availability,  $md_{q,p,j}$ .

### Maintenance scheduling, starts limit

$$sAcc_{q,p,j} = sAcc_{q,p-1,j} + \left( \sum_{s,s'} y_{q,s,s',p,j} \right) (STM_{q,p,s,s'}) - mS_{q,p,j} \forall q, p, j \quad (2.113)$$

$$sAcc_{q,p,j} \leq MST \quad (2.114)$$

$$mS_{q,p,j} \leq sAcc_{q,p-1,j} + \sum_{s,s'} (y_{q,s,s',p,j}) (STM_{q,p,s,s'}) \quad (2.115)$$

$$mS_{q,p,j} \leq (M)(mb_{q,p,j}) \quad (2.116)$$

$$\sum_{p=0}^p mb_{q,p,j} \leq \frac{\sum_{s,s',p=0}^p (y_{q,s,s',p,j}) (STM_{q,p,s,s'})}{MST} + 1 \quad (2.117)$$

As in the objective function, to enforce the maintenance inspection start limit for a

long-term service agreement, calculating the number of starts requires summing the starts variable  $y_{q,s,s',p,j}$  for each plant  $j$  in each period  $p$  scaled by the number of transitions that occur,  $STM_{q,p,s,s'}$ . All other constraints directly reflect their hourly counterparts.

### Maintenance scheduling, firing hours limit

$$hAcc_{q,p,j} = hAcc_{q,p-1,j} + \left( \sum_s umd_{q,s,p,j} \right) (SDM_{q,p,s}) - mF_{q,p,j} \forall q, p, j \quad (2.118)$$

$$hAcc_{q,p,j} \leq MFH \quad (2.119)$$

$$mF_{q,p,j} \leq hAcc_{q,p-1,j} + \sum_s (umd_{q,s,p,j}) (SDM_{q,p,s}) \quad (2.120)$$

$$mF_{q,p,j} \leq (M)(mb_{q,p,j}) \quad (2.121)$$

$$\sum_{p=0}^p mb_{q,p,j} \leq \frac{\sum_{s,p=0}^p (umd_{q,s,p,j}) (SDM_{q,p,s})}{MFH} + 1 \quad (2.122)$$

Enforcing the firing hours threshold for long-term service agreement requires an identical arithmetic approach to enforcing the starts limit, save for the fact that an estimate of firing hours sums the combined commitment/maintenance variable  $umd_{q,s,p,j}$  and scales by the duration parameter  $SDM_{q,p,s}$ . Note that in the firing hours and starts limit formulations for maintenance scheduling, the only substantial difference is the calculation of firing hours and starts estimates.

### Forward capacity commitment

$$\sum_g fcc_{q,a,g} = FCM_a \forall q, a \quad (2.123)$$

$$fcc_{q,a,g} \leq fcc_{MAX,NONGAS,q,a,g} + fcc_{MAX,GAS,q,a,g} \quad (2.124)$$

$$fcc_{NJ,q,d,nj} \leq (\overline{X}_{nj})(FOR_{nj}) \quad (2.125)$$

$$fcc_{MAX,NONGAS,q,a,g} \leq \sum_{nj \in g} fcc_{NJ,q,d,nj} \forall q, g \quad (2.126)$$

$$fcc_{J,q,d,j} \leq (\overline{X}_j)(1 - md_{q,p,j}) \forall q, d \in p, p, j \quad (2.127)$$

$$fcc_{\text{MAX,GAS},q,a,g} \leq \sum_{j \in g} fcc_{J,q,d,j} \forall q, a, d \in a, g \quad (2.128)$$

$$\sum_{j \in g, (q,p,s) \in SH} (fcc_{J,q,d,j})(H_j)(SDD_{q,p,s}) \leq fx_{\text{LT},g} + fx_{\text{ST},q,d,g} \forall q, d \in p, p, g \quad (2.129)$$

$$fcc_{\text{GAS},q,a,g} \leq \sum_{j \in g} (\bar{X}_j)(1 - md_{q,p,j}) \forall p \in a, a, g \quad (2.130)$$

The forward capacity constraints map directly from their hourly counterparts.

### Risk aversion

The constraints to model risk aversion with respect to not being able to acquire enough transportation in the short term can be directly copied from the hourly unit commitment (Equations 2.80-2.83) because the hourly unit commitment balances gas on a daily basis. The constraints below repeat the constraints in Equations 2.80-2.83, replacing the discrete scenario variables with  $q$  for simplicity:

$$a_{\text{ST},q,d,g} \geq 1 - \frac{fx_{\text{LT},g}}{f_{q,d,g}} \forall q, g, d \quad (2.131)$$

$$a_{\text{LT},q,g} = 1 - \sum_d \frac{a_{\text{ST},q,d,g}}{D} \forall q, g \quad (2.132)$$

$$a_{\text{min},g} - \sum_q \frac{(P_q)(a_{q,g})}{1 - \beta_g} \geq A_{\text{min},g} \forall q, g \quad (2.133)$$

$$a_{q,g} \geq a_{\text{min},g} - a_{\text{LT},q,g} \forall q, g \quad (2.134)$$

### Positivity and integer constraints

And lastly, the positivity and integer constraints also map directly from their hourly counterparts.

$$x, w, y, z, fx_{\text{ST}}, fx_{\text{LT}}, f, s, fh,$$

$$umd, md, mS, mF, sACC, hACC,$$

$$fcc, fcc_{\text{NONGAS}}, fcc_{\text{GAS}}, fcc_{\text{NJ}}, fcc_J \geq 0 \quad \text{nonnegativity} \quad (2.135)$$

$$u_{q,s,s',p,i}, mb_{q,p,j}, mc_{j,l} \in \{0, 1\} \forall q, l, s, s', p, i, j \quad \text{binary decisions} \quad (2.136)$$



In summary, the system state approximation reformulation of the central planner’s combined gas-electricity problem is as follows. Let  $\Omega$  represent all of the decision variables enumerated in equations 2.135 and 2.136; then, the central planner solves:

$$\begin{array}{ll}
 \min_{\Omega} & \text{Eq. 2.93} \\
 \text{s.t.} & \text{Eqs. 2.94-2.102} \quad \text{unit commitment} \\
 & \text{Eqs. 2.103-2.105} \quad \text{fuel constraints} \\
 & \text{Eqs. 2.106-2.109} \quad \text{LTSA selection} \\
 & \text{Eqs. 2.110-2.122} \quad \text{maintenance} \\
 & \text{Eqs. 2.123-2.130} \quad \text{fwd. capacity} \\
 & \text{Eqs. 2.131-2.83} \quad \text{risk aversion} \\
 & \text{Eqs. 2.135-2.136} \quad \text{positivity, integers}
 \end{array}$$

## 2.4 Summary and next steps

To study the optimal behavior of firms with gas-fired power plants over the long and short term, we proposed a mathematical formulation of an equivalent centrally planned problem that relies on assumptions of perfect competition and equivalence between welfare maximization and cost minimization. The centrally planned problem, at its core, relies on a fuel-constrained unit commitment for scheduling and dispatch. To make the hourly unit commitment tractable over a period of many years, in this chapter we also described a method to solve different timescale problems independently and then reintegrate each solution as an approximation to solving the full hourly formulation. This approach relies on using system states to replace the hourly formulation in the long and medium term and holding these decisions constant when solving for shorter term decisions. The next chapter applies the mathematical models developed here to a real-size system to explore how decisions interact with one another and to study the reliability and market dynamics of a gas-constrained electric power system.

THIS PAGE INTENTIONALLY LEFT BLANK

# Chapter 3

## Case study

New England is the first region in the United States to experience substantial gas and electricity problems due to both increased consumption of natural gas by the electricity sector and scarcity of pipeline capacity in the gas sector. Leading up to 2013, a confluence of environmental, technical, and financial issues gradually reduced the number of coal and nuclear power plants in New England, and in 2013 the Independent System Operator of New England (ISO-NE) started to cite gas-electricity challenges as one of its most prominent concerns in its annual regional system planning report [ISO-New England, 2013a]. Today, approximately one-half of all power plant capacity in New England requires natural gas. The region's large fraction of gas-fired power plants limits the power system's ability to substitute other technologies during pipeline scarcity events, creating both financial correlations between New England's electricity and gas prices (see Figure 3-1<sup>1</sup>) and reliability concerns. Given New England's dependence on natural gas and the interesting market and policy problems that it faces, in this case study, we apply the gas-electricity model created in Chapter 2 to a representative system inspired by New England to examine how firms should make key decisions and to gain insight about some of the aggregate impacts of these individual decisions on the gas-electricity system as a whole.

---

<sup>1</sup>Sources: [http://www.iso-ne.com/markets/mkt\\_anlys\\_rpts/whlse\\_load/select/WhlseLoad.do](http://www.iso-ne.com/markets/mkt_anlys_rpts/whlse_load/select/WhlseLoad.do); [http://www.eia.gov/dnav/ng/ng\\_pri\\_sum\\_a\\_epg0\\_pg1\\_dmcf\\_m.htm](http://www.eia.gov/dnav/ng/ng_pri_sum_a_epg0_pg1_dmcf_m.htm)

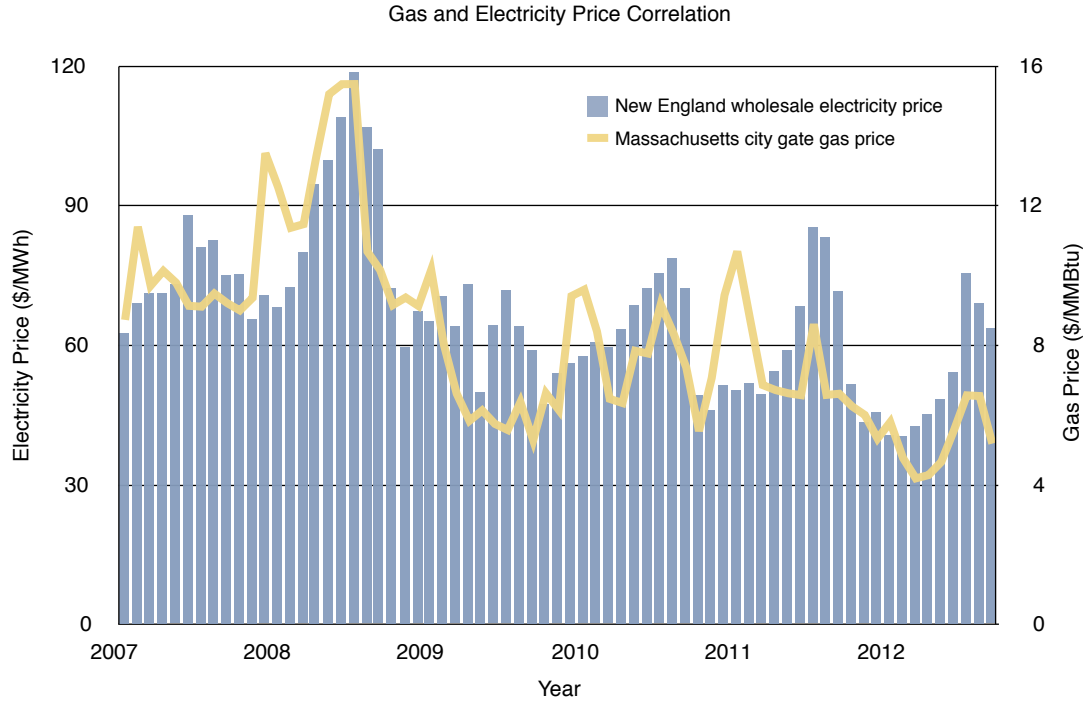

Figure 3-1: New England gas and electricity price correlation

### 3.1 Input data

The data for this case study is based on public data published by ISO-NE and the United States Energy Information Administration (EIA). The model's primary data inputs and parameters include ISO-NE's 2010-2013 hourly electricity demand, ISO-NE's 2013 winter seasonal availability report<sup>2</sup>, EIA's 2013 gas prices for the New England region, and EIA's estimate of average heat rates for power plants. Table 3.1 summarizes the set of power plants available for dispatch in this model based on ISO-NE and EIA's data; as previously noted, most of New England's power plant capacity consists of nuclear and gas technologies.

<sup>2</sup>[http://www.iso-ne.com/genrtion\\_resrcs/snl\\_clmd\\_cap/2013/index.html](http://www.iso-ne.com/genrtion_resrcs/snl_clmd_cap/2013/index.html)

	no. of plants	capacity range (MW)	average heat rate (MMBtu/MWh)	total capacity (MW)
nuclear	5	[556-1247]	10.4	4656
coal	10	[48-622]	10.3	2300
gas	48	[2-858]	7.7	11489
diesel	41	[1-49]	10.9	568
jet fuel	37	[5-68]	11	1140
oil	62	[10-606]	11	9926

Table 3.1: Summary of dispatchable ISO-NE power plants, 2013

New England’s electricity demand exhibits daily and seasonal patterns. Figure 3-2 shows New England’s annual electricity demand in 2013, while Figure 3-3 shows New England’s electricity demand for a typical week in the spring (April 11 to 18, 2013), and Figure 3-4 shows New England’s weekly electricity demand for a typical week in the summer (July 15 to 22, 2013). In the spring, electricity demand is at its lowest compared to the rest of the year, and daily demand tends to feature two intraday peaks—one in the morning and another in the evening. By contrast, in the summer, demand is at its highest relative to the rest of the year, and daily demand features a single mid-afternoon peak. Section 3.2.1 reviews the system state approximation’s representation of these different demand patterns given that they can strongly condition the investment and operation decisions that electricity generation firms make.

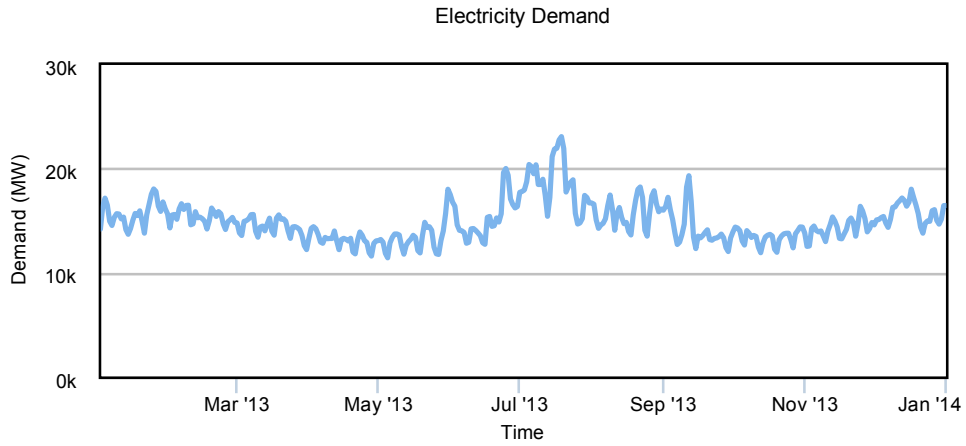

Figure 3-2: 2013 New England Annual Electricity Demand

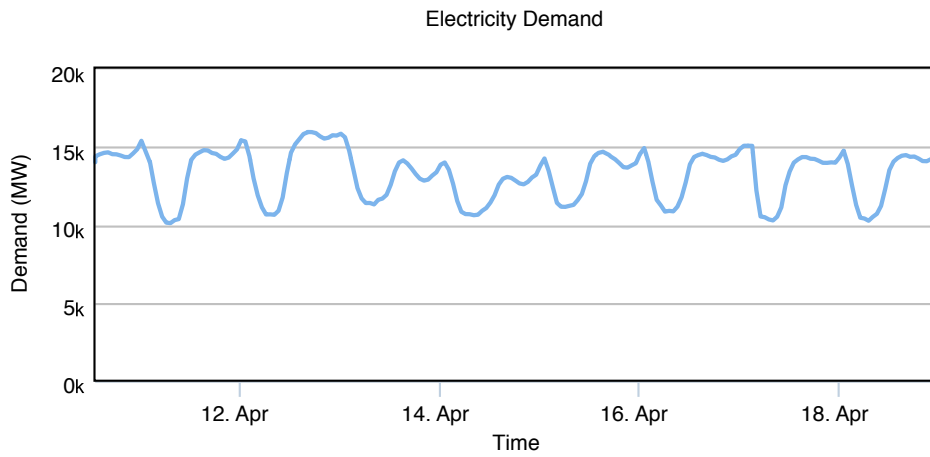

Figure 3-3: New England Electricity Demand, April 11-18, 2013

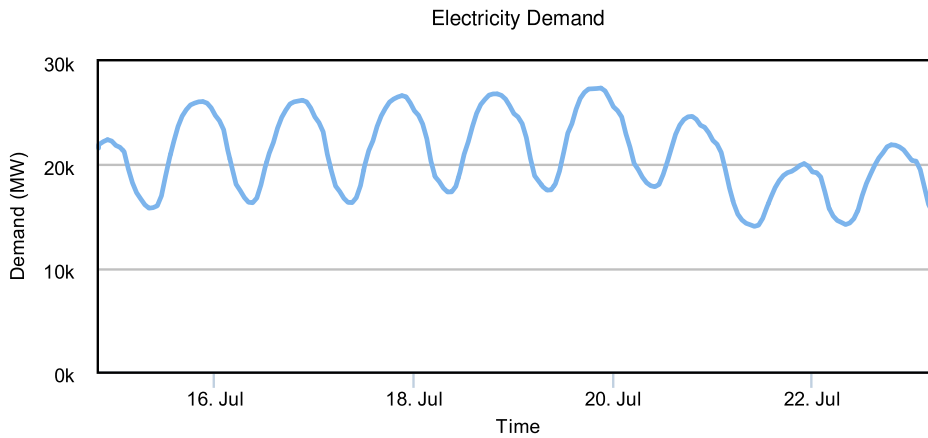

Figure 3-4: New England Electricity Demand, July 15 to July 22, 2013

Lastly for input data, Figure 3-5 shows representative historical gas prices at Al-

gonquin, the main pipeline by natural gas enters New England, in 2013 separated by transportation and commodity. The commodity component of the gas price reflects daily prices at Henry Hub, while the transportation component represents the difference between prices at Algonquin and Henry Hub. New England historically experiences its highest gas prices between the late fall and early spring, when demand for gas for both electricity and heating tends to consume almost all available pipeline capacity in the region.

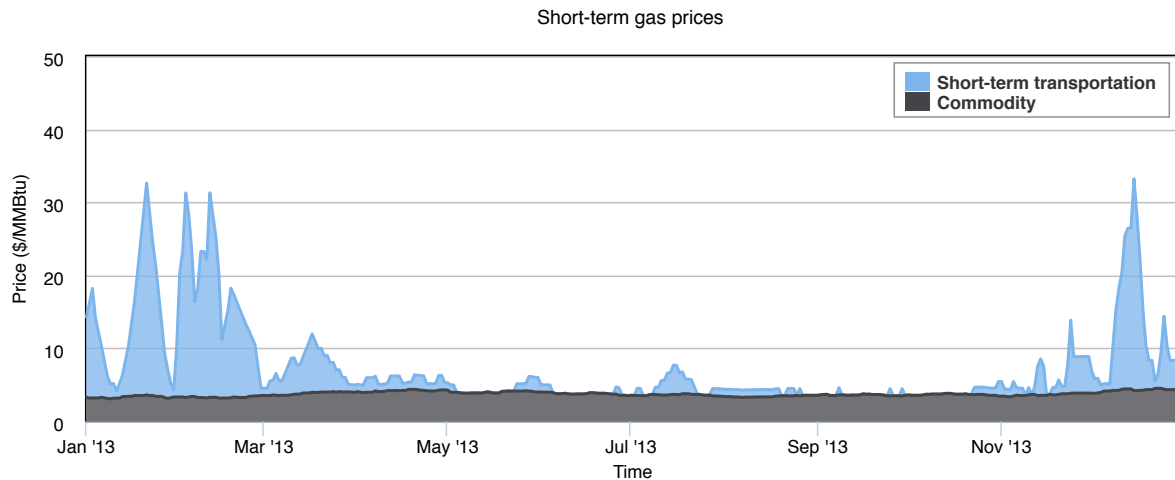

Figure 3-5: 2013 Algonquin Gas Prices (based on EIA data)

## 3.2 Benchmarks

To study pipeline adequacy issues and other gas-electricity interactions, in this case study, we will build a power system inspired by New England by combining ISO-NE’s list of dispatchable power plants, historical electricity demand EIA’s historical gas prices as described in section 3.1, and the single-node electricity and gas model presented in Chapter 2. Due to the number of new decisions that we have added to the basic unit commitment problem, as well as the system state approximation used to achieve computational tractability, the model presented in Chapter 2 can result in interactions between decisions that are difficult to understand.

To aid our understanding, in this section we examine decisions individually using a smaller set of input data. First, we will examine how well the system state ap-

proximation works by comparing unit commitment results with a basic hourly unit commitment model. Then, we highlight how the system behaves depending on the decisions made by conducting a series of “experiments” in which we fix all but one decision and then explore how that decision responds to different parameters. In aggregate, these exercises provide common-sense checks for the model formulated in Chapter 2. For example, if natural gas is free, then we would expect firms to use as much natural gas as possible on any given day. Conversely, if natural gas is extremely expensive relative to other fuels, then we would expect firms to use much less natural gas, unless there are no other suitable substitutes. In addition to serving as common-sense checks against intuition, these experiments may reveal interesting relationship for future exploration. All results were obtained from optimizations with relative tolerances of 0.01 or less.

### **3.2.1 System state versus hourly unit commitment**

As the modeling for this dissertation relies heavily on the system state approximation technique described in Chapter 2.3.1 to achieve computational tractability, we first provide benchmarks to compare results between a basic unit commitment based on system states versus an hourly formulation. For these benchmark runs, each unit commitment operates over a three-month time period from January 2013 to March 2013, using the full-sized power system input data described in section 3.1. The system state model approximates the hourly problem using eight, sixteen, and thirty two system states. The exact number of states is arbitrary, and more states allow more precision. However, the transition matrix grows by the square of the number of states, so increasing the number of states also quickly increases the number of decision variables. Figure 3-6 shows how each hour maps to a system state in January 2013 for the eight-state representation. Notably, because eight states is coarse, the approximation captures hourly dynamics accurately—but not necessarily with precision. Increasing the number of states would increase the precision of the approximation, but at the added cost of more computational time (Table 3.2 compares computational details for each approach).



January 2013 ISO-NE Electricity Demand

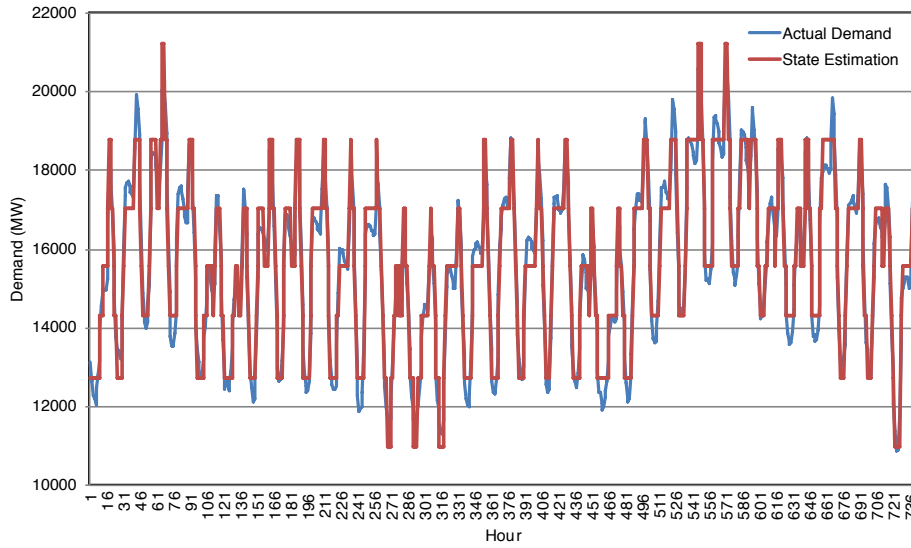

Figure 3-6: System state approximation of electricity demand

Figure 3-7 shows the hourly unit commitment and system state approximation's dispatch schedule for January 2013 given 203 individual power plants. Three common unit commitment features are visible in this figure. At the bottom of both schedules, for demand below approximately 2500 MW, baseload units serve constant demand throughout the month without cycling on and off. Between approximately 2500 MW and 10000 MW, power plants remain on most hours of the month, but ramp up and down to follow load. For the remaining peak demand above 10000 MW in both schedules, power plants ramp up and down and cycle on and off to balance electricity demand with supply.

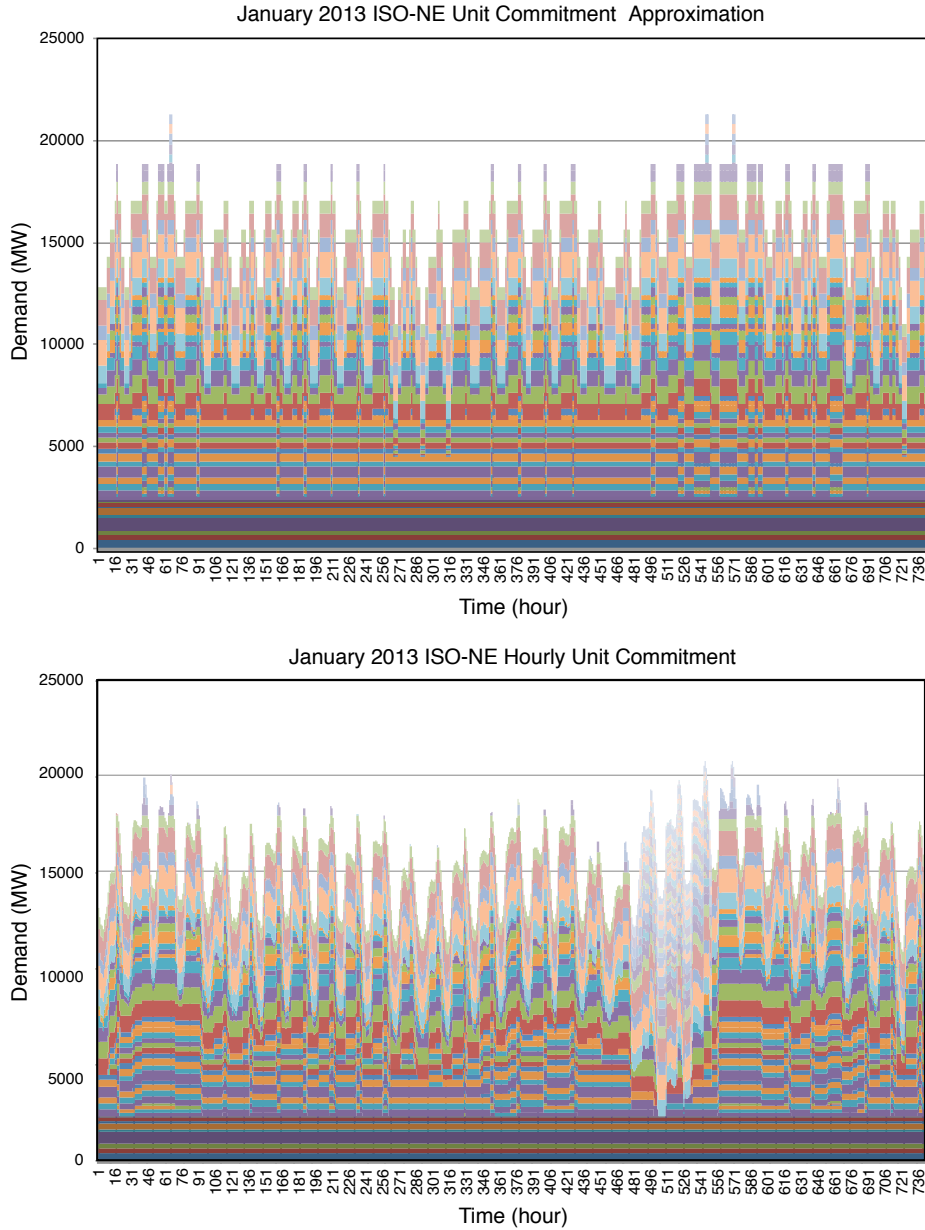

Figure 3-7: One-month dispatch: (top) system state; (bottom) hourly formulation

Figure 3-7 also qualitatively illustrates the system state approximation’s primary differences compared to the hourly unit commitment. Notable differences can occur between the dispatch schedules of both methods due to the fact that the approximation neither precisely replicates hourly demand nor the full hourly problem formulation. In this particular example, the system state approximation only uses eight load levels and does not explicitly enforce ramp constraints, leading to observable differences in the amount of energy generated between the dispatch schedules for intermediate units

throughout the month and particularly during the third week of January.

To quantitatively measure differences between the hourly formulation and the system state approach, we normalize and measure commitment plan differences as follows (this is the same metric used in [Palmintier and Webster, 2012] to study binary clustering as a dimensionality reduction technique for unit commitment):

$$\Delta U = \frac{\sum_{i,t} \frac{(u_{\text{state},i,t} - u_{\text{binary},i,t})}{u_{\text{binary},i,t}}}{T} \quad (3.1)$$

where  $u_{\text{state},i,t}$  represents the system state commitment decision for plant  $i$  at time  $t$ , and  $u_{\text{binary},i,t}$  represents the binary formulation's commitment decision for plant  $i$  at time  $t$ . Smaller values for  $\Delta U$  indicate commitment results that exhibit greater similarity. Tables 3.2 and 3.3 compare the two model's estimates of fuel consumption, commitment decisions, commitment costs, total system costs, and computation details for a three-month unit commitment from the beginning of January to the end of March 2013.<sup>3</sup> The results shown in these tables are from the same unit commitment problems shown in Figure 3-7; however, to make the dispatch schedule easier to visualize, Figure 3-7 only shows a subset of the total generation results.

In these numerical benchmarks, the system state approximation results closely match the hourly formulation's results for outputs of interest. Using eight system states resulted in a normalized mean unit commitment difference measure of  $\Delta U = 0.066$ . For comparison, using 16 states in this example resulted in  $\Delta U = 0.052$ , and using 32 states resulted in  $\Delta U = 0.053$  when solving each mixed-integer linear program with a tolerance of 0.001. The slight increase in the normalized error rate between 16 and 32 states is likely due to the nature of solving problems with binary variables because the solver stops once it finds a solution within the desired tolerance. For the purposes of benchmarking the system state approach, we can state that the normalized error for commitment decisions ranges between 5% to 6%.<sup>4</sup>

---

<sup>3</sup>Computation times are for a computer with an Intel 2.7 GHz i5 processor running GAMS/C-PLEX 12.5 on three cores and eight gigabytes of memory on OS X (10.9, Mavericks).

<sup>4</sup>For comparison to other approximation techniques, the error rate cited in [Palmintier and Webster, 2012], which clusters groups of identical power plants together and converts the binary unit commitment formulation into an integer problem, exhibits error rates

	hourly model	8 states	16 states	32 states
total cost	\$2.25 billion	\$2.27 billion	\$2.27 billion	\$2.27 billion
fuel	127 trillion BTU	135 trillion BTU	135 trillion BTU	135 trillion BTU
plant starts	1236	1273	1342	1306
commit. costs	\$236 million	\$243 million	\$245 million	\$246 million

Table 3.2: System state versus hourly unit commitment results

	hourly model	8 states	16 states	32 states
variables	1,762,652	88,220	333,020	1,292,636
equations	2,205,452	127,412	489,740	1,919,420
execution time	715 seconds	1.12 seconds	3.93 seconds	17.3 seconds
$\Delta U$	-	0.066	0.052	0.053

Table 3.3: System state versus hourly unit commitment computation details

The system state approximation does coarsely replicate hourly dispatch decisions with the added advantage of making long-term unit commitment problems computationally tractable. Given this, numerical results reported in this case study for costs, fuel usage, and other decisions should be treated as first-order estimates for the purpose of gaining insights about gas-electricity relationships.

### 3.2.2 Isolated decisions

Using the system state approximation technique to model a power system over a timeframe of three years, we now conduct a series of “experiments” to gain intuition about the relationships between individual decisions and parameters. In these “experiments,” we only consider a single, deterministic case consisting of high electricity demand (ISO-NE’s 2013 electricity demand plus an arbitrary additional base load demand of 10,000 MW throughout the year), high coal prices (approximately closer to 0.1%. However, due to the key decisions in this study related to long-term service agreements and maintenance scheduling, clustering is not an appropriate approximation technique to apply. For additional benchmarking using system states, see [Wogrin et al., 2012].

\$5/MMBtu), and the presence of a large gas consumer with pipeline capacity priority (e.g., a local distribution company). For the purpose of exploring decisions in isolation, these inputs should specifically allow interesting market effects to appear due to substitution between coal and gas technologies.

We will review isolated decisions for long-term gas purchases, maintenance contract selection, maintenance scheduling, and forward capacity obligations. For gas purchase decisions, all power plants were assigned to the same long-term service agreement with a cost of \$10 million, 250 starts, and 25,000 firing hours. Second, for service agreement decisions, long-term gas transportation decisions were frozen at 1 BCF. Third, for maintenance scheduling, power plants were split evenly between contract 0 (\$10 million, 250 starts, 25000 firing hours) and contract 1 (\$27.5 million, 750 starts, 25000 firing hours). The price for contract 1 reflects the price that evenly splits plants in the system between both contracts. For all runs in this exploration, the system operator sets a forward capacity threshold of 20,000 MW. Finally, to further reduce the computation time required for these exploratory runs, we only consider the reduced set of scaled power plants and firms shown in Table 3.4, which consists of one monolithic, coal-fired power plant and ten smaller gas-fired power plants.

	technology	# of plants	capacity per plant (MW)	avg. heat rate
firm 1	coal	1	10000	10
firm 2	gas	10	2000	10.3

Table 3.4: Power plant data subset for exploring isolated decisions

### Gas transportation and commodity purchases

For long-term gas transportation and short-term commodity decisions, the following set of charts explores a large range of price sensitivities for firm transportation. If we observe that despite high prices (relative to the spot market), firms continue to purchase long-term pipeline transportation, then we may be able to identify a key dependency of the electric power system on natural gas that either 1) existing technologies cannot currently serve as substitutes for, or 2) may signal investment op-

opportunities for new entrants. Therefore, although long-term pipeline transportation prices are unlikely to reach the upper bound of \$1000/MMBtu given that transportation costs in 2013 added no more than \$40/MMBtu to the commodity price in New England, starting with this wide range of transportation prices may provide useful insights about gas-electricity interactions.

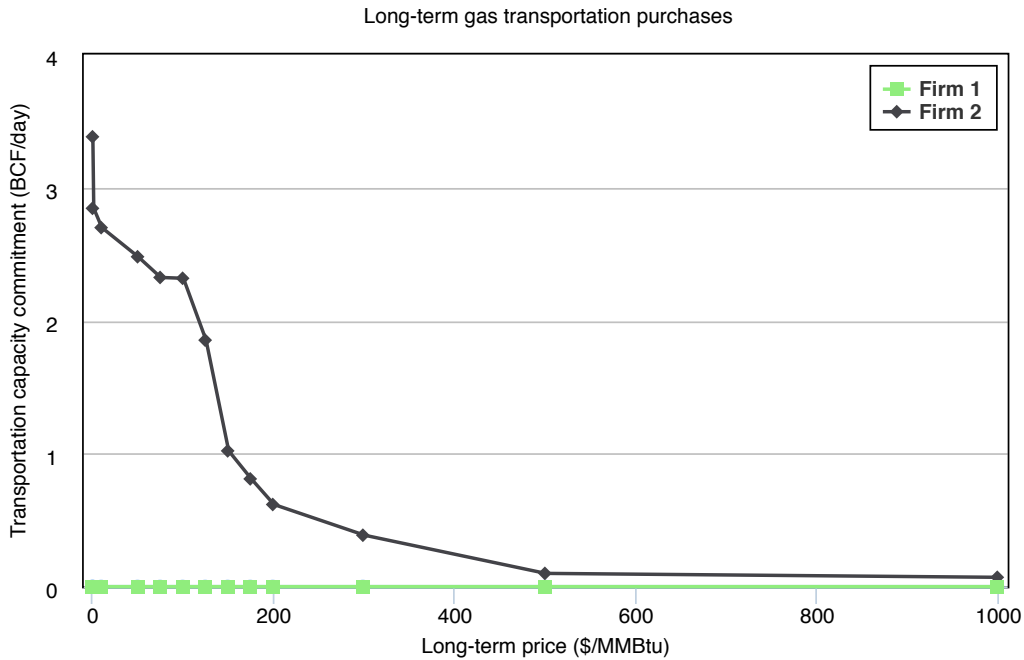

Figure 3-8: Isolated long-term pipeline firm transportation decision

Figure 3-8 shows firm 2’s commitment to long-term, firm pipeline capacity. Two interesting features appear in Figure 3-8 that merit further explanation. First, the “plateau” observed near the price of \$100/MMBtu enables the firm to offer forward capacity (this is further discussed in section 3.2.2). Second, the small quantity of transportation purchased when prices exceed \$300/MMBtu is due to the lack of other generation technologies in New England and the pipeline shortages that occur with certainty in this deterministic scenario.

Figure 3-9, which estimates firm 2’s daily gas purchases over the entire year, illustrates this interaction between a lack of generation alternatives and pipeline capacity shortages more clearly. Each data point in Figure 3-8 and each chart in Figure 3-9 represents a different optimization run. Over the set of six runs shown, the price of

long-term pipeline capacity varies from low ( $\$/\text{MMBtu}$ ) to high ( $\$1000/\text{MMBtu}$ ). When the price of transportation is zero, the generation firm purchases all of the transportation that it needs ahead of time. As the price of long-term pipeline transportation increases, the generation firm increasingly relies on the spot market to acquire pipeline capacity. During times of scarcity (for example, during January and February) if the price of long-term pipeline transportation is too high, the firm substantially reduces consumption. However, even at extremely high long-term prices that are one and two orders of magnitude higher than spot prices, the cost-minimizing solution still involves a small purchase of firm transportation to meet the firm's minimal gas requirements in January and February; this purchase highlights both a gas-electricity dependency and a potential investment opportunity for new entrants.

Comparing the firm's behavior when long-term pipeline transportation is inexpensive (the top two charts in Figure 3-9) with the firm's behavior when long-term pipeline transportation is expensive (the bottom two charts in Figure 3-9), when transportation is inexpensive, the firm's transportation purchases can exceed its actual gas consumption. In contrast, when transportation is extremely expensive, the firm buys just enough to meet its minimum requirements throughout the year. Additionally, high long-term pipeline transportation prices relative to spot market prices also suppress total gas consumption. From the central planner problem's perspective, these graphs illustrate the trade-off between investing in pipeline capacity to allow gas-fired power plants to run versus quitting consumption and substituting other technologies. From the individual firm's perspective, these graphs illustrate the prices and quantities at which securing guaranteed pipeline capacity could be profitable (keeping in mind the deterministic nature of this particular experiment). The firm's behavior largely follows economic intuition. As prices rise, the firm's consumption decreases. However, in section 3.2.2, we explore the relationship between forward capacity commitments and long-term gas purchases and highlight an interaction between the two that is not obvious by only examining Figures 3-8 and 3-9.

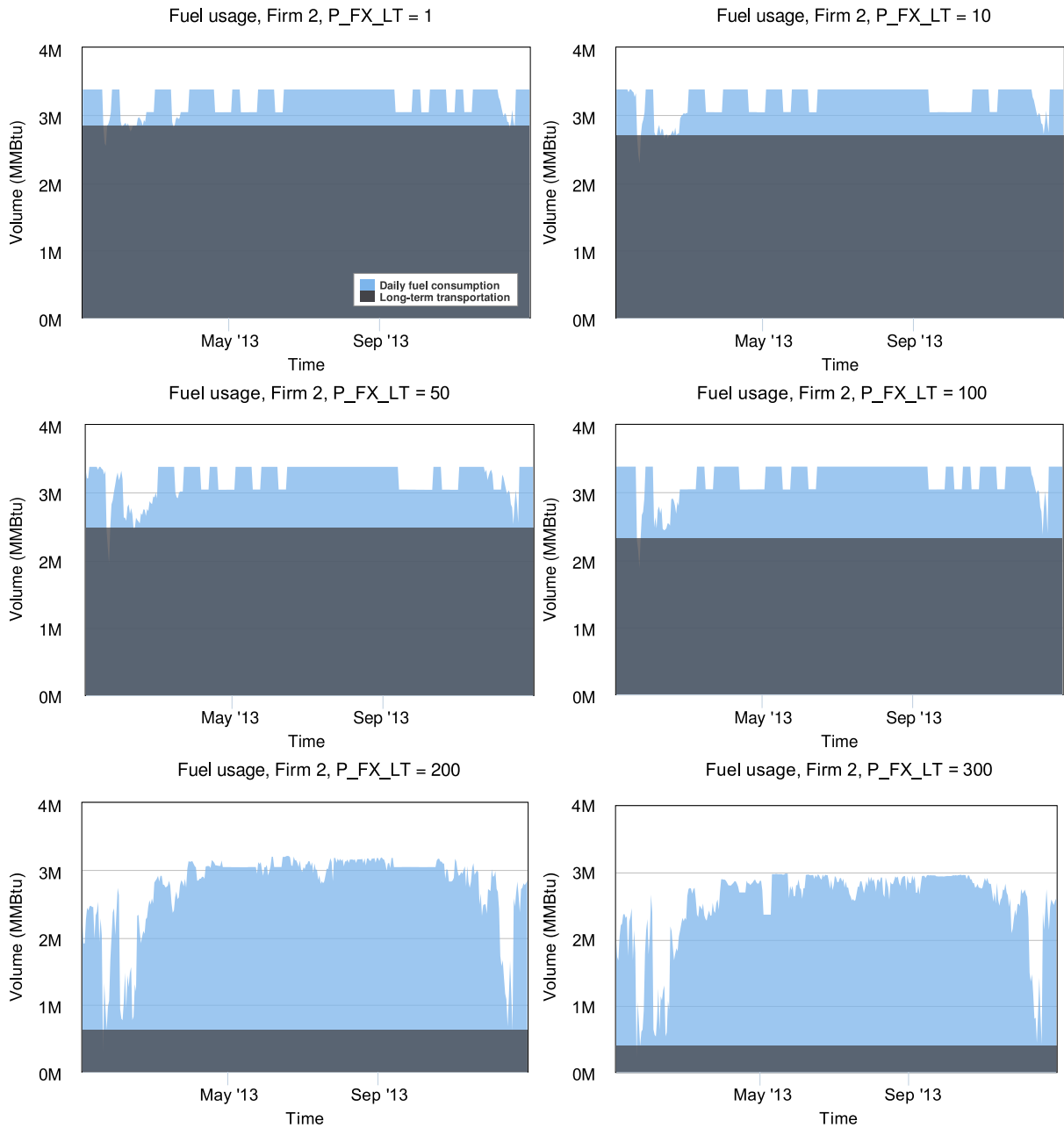

Figure 3-9: Estimation of firm 2’s daily short-term gas purchases for 2013

### Long-term service agreements

Choosing long-term service agreements (LTSAs) for gas-fired power plants requires a firm to decide how to trade off between cost and flexibility. In this case, “flexibility” represents a greater number of starts per maintenance agreement. Depending on the rest of the power system, however, a firm may not want or need this extra flexibility.



For example, in a power system in which gas-fired power plants remain constantly on and serve constant load, paying \$10 million more for a service agreement that allows 500 more starts may not make much sense if a power plant cannot use these extra starts before its service agreement expires. Alternatively, if a firm is uncertain about the future operating regime of its power plants, it may want the more flexible contract to hedge against uncertainty (Section 3.2.3 discusses this hedge in greater detail).

To examine the model's representation of service agreements, we fix firm 2's long-term gas purchase decisions at 1 BCF and the contract 0's premium at \$10 million. Then, we iteratively run optimizations with premiums ranging from \$0 to \$50 million for the contract 1, which offers 500 more starts than contract 0 and the same number of firing hours. Figure 3-8 shows how the firm that owns gas-fired power plants divides its ten plants among the two available service agreements at different price premiums for the more flexible service agreement. Matching intuition, the firm exclusively prefers contract 1 when its price is less than or equal to the fixed price for the less flexible contract. However, as the price for flexibility increases, the firm trades off between the two agreements and reaches a break-even split between the two contracts when the more flexible contract is priced at \$27.5 million. Shortly after the break-even point, the firm exclusively prefers the less flexible and less expensive contract (because the extra starts are no longer worth the extra cost). Observing how firms trade off between cost and flexibility in their selection for long-term service agreements can provide useful insights about how firms might adapt to new operating regimes and changes in the economic merit order (due to any number of reasons, including the introduction of renewables or high gas prices due to pipeline scarcities) to remain economically viable.

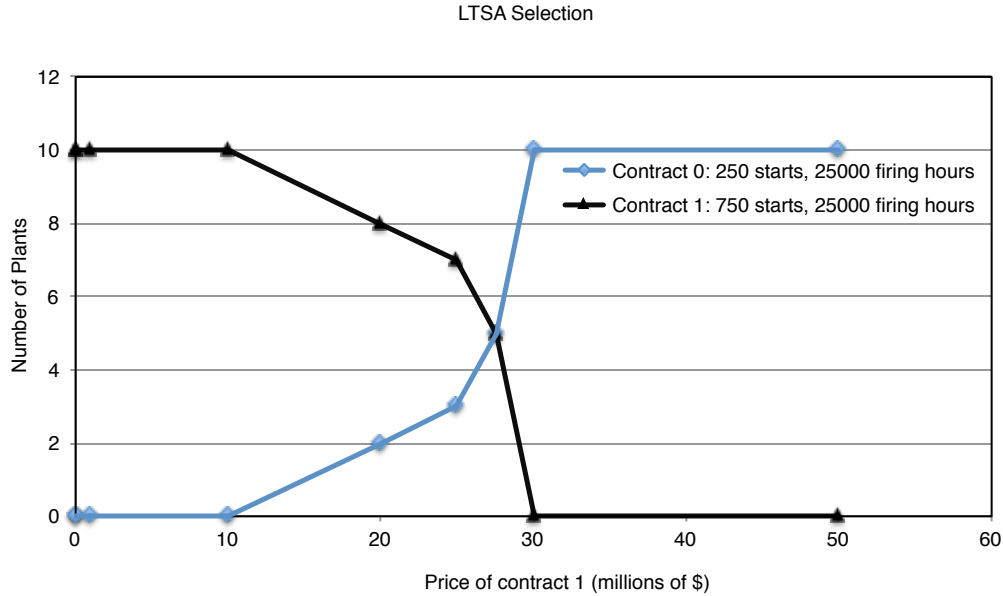

Figure 3-10: Isolated long-term service agreement decision

### Maintenance scheduling

Firms must perform regular maintenance on all of their power plants. In power systems with wholesale markets, firms try to schedule these maintenance events during times of the year when they otherwise would make little profit. Typically, this leads to maintenance schedules in which available gas-fired power plant capacity reaches its minimum in the late winter/early spring and its maximum during the summer. Figure 3-11 shows an approximate solution for maintenance schedules from a long-term run for firm 2's gas plants after fixing firm 2's long-term pipeline transportation decision at 1 BCF and setting the price for service contract 1 to \$27.5 million. Figure 3-12 shows the actual maintenance schedule from a medium-term run for firm 2's gas plants under the same set of long-term decisions. Each time period in a long-term run represents one month, while each time period in a medium-term run represents one week. The maintenance solution spreads maintenance amongst plants so that at any particular time, only one of the ten plants is offline for maintenance. The long- and medium-term maintenance schedules show the same general shape that maximizes gas-fired power plant capacity between June and August, matching empirical observations from the power sector.

Figures 3-11 and 3-12 also show, for the first time in this case study, the time step differences between the long and the medium term optimizations. In long-term runs, one period represents a month. In medium-term runs, one period represents a week. In long-term runs, as shown in Figure 3-11, when a plant is taken offline, the least amount of time that the plant must stay offline for is one month. By contrast, Figure 3-11 represents a maintenance schedule from a medium-term run that utilizes a time step of one week (a more realistic timeframe for actual maintenance). Importantly, the maintenance schedule approximation from the long-term run is just that—an approximation to help make long-term pipeline transportation and service agreement decisions. For actual maintenance scheduling, which requires more precision, we need to switch to the medium-term model. This is the same distinction that exists between the system state model and the hourly unit commitment with respect to short-term operations: while the system state model approximates the short-term for the purpose of informing medium- and long-term decisions and obtaining useful system insights, for actual short-term, hourly operations, we must switch back to the hourly unit commitment.

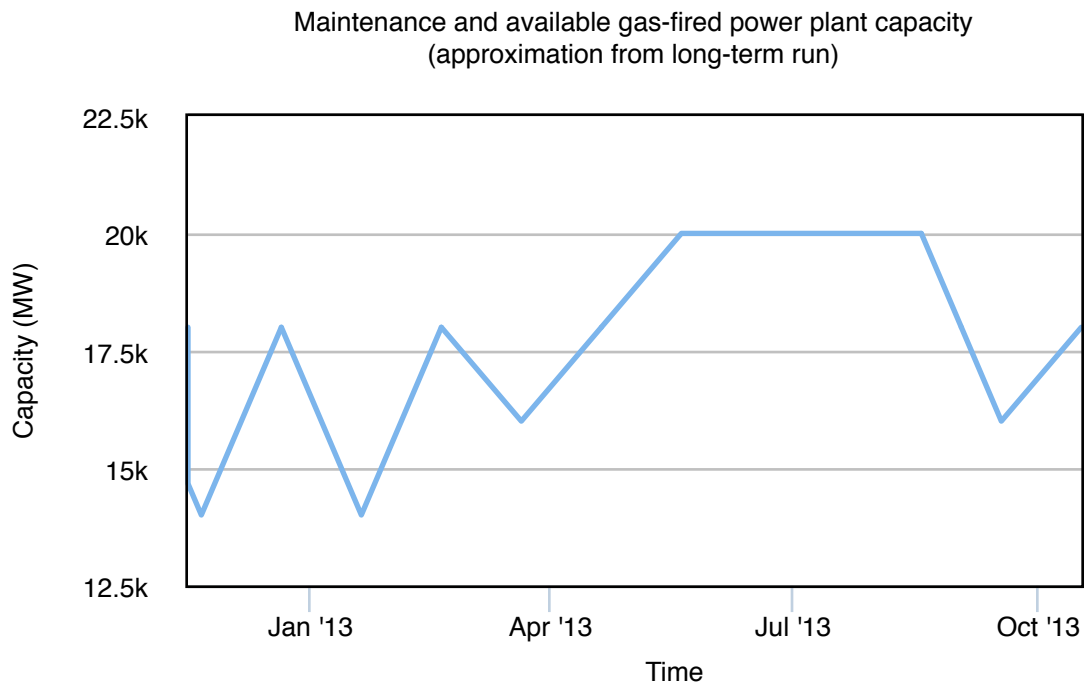

Figure 3-11: Estimated available gas-fired power plant capacity based on aggregate scheduled outages (long-term approximation)

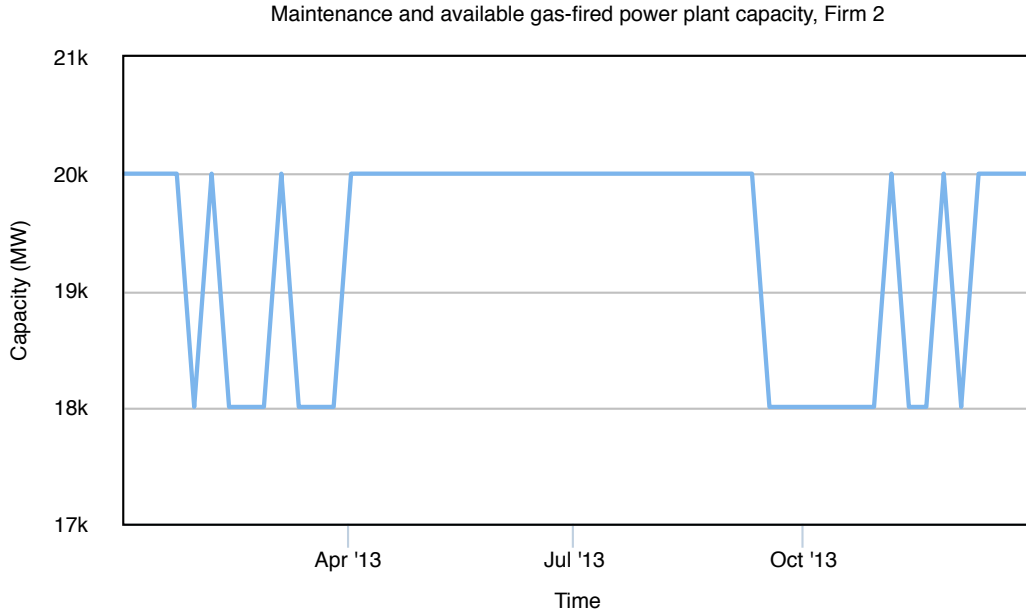

Figure 3-12: Estimated available gas-fired power plant capacity based on aggregate scheduled outages (medium-term solution)

### Forward capacity commitments

In the forward capacity market, we expect to observe two broad trends. First, as the price of long-term pipeline transportation increases, firms should respond by purchasing less firm transportation and offering less power plant capacity if they rely on long-term firm transportation to ensure that they have adequate gas supplies. Second, if acquiring forward capacity via other technologies costs more than acquiring that same capacity from natural gas technologies, then firms will continue to purchase long-term pipeline transportation as needed—even as the price rises—until another technology becomes economically competitive.

Figure 3-13 shows the medium-term results for the forward capacity market after fixing the long-term service agreements for all power plants to contract 0 (\$10 million, 250 starts, 25000 firing hours) and setting the forward capacity target at 20,000 MW. The results contain multiple runs, each with different prices for long-term pipeline transportation ranging from \$0/MMBtu to \$500/MMBtu. (Figure 3-8 contains the corresponding long-term pipeline transportation purchases for Figure 3-13.) Given this particular set of deterministic cases, the two firms' contributions to forward ca-

capacity exhibit both of the expected trends that relate long-term pipeline transportation prices to forward capacity commitments and technology substitutions. When the price of long-term pipeline transportation is less than \$100/MMBtu, the firm with gas-fired power plants always contributes nearly the maximum capacity of its portfolio (specifically, it always commits to making nine of its ten plants available to accommodate a maintenance schedule similar to the one shown in Figure 3-11). However, as the price of long-term pipeline transportation increases, acquiring forward capacity from the coal plant becomes less expensive, and technology substitution reduces the forward capacity contribution of gas-fired power plants. The interaction between the forward capacity market and long-term pipeline transportation is visible upon closer inspection of Figure 3-13. Absent other effects, we would expect long-term purchases to decline in a convex manner as the price of transportation increases. However, the long-term pipeline transportation purchases shown in Figure 3-13 do not match this pattern. In particular, a “plateau” exists in long-term pipeline transportation purchases near \$100/MMBtu. However, the plateau is consistent with the firm’s constant forward capacity offer of 18,000 MW up to a long-term pipeline transportation price of \$100/MMBtu, after which both its long-term pipeline transportation purchases and forward capacity commitments decline.

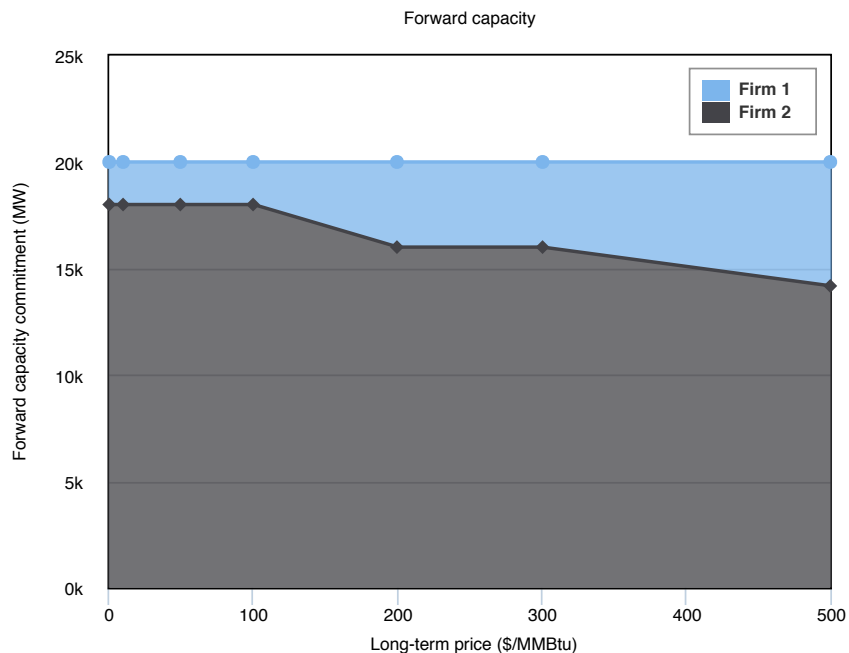

Figure 3-13: Forward capacity commitment for different long-term pipeline transportation prices

### 3.2.3 Simultaneous decisions

After having reviewed each of the firm's individual decisions in detail, now we allow all decisions to interact simultaneously with one another when (1) there is no other gas consumer (and hence, the electric power industry may use all of the region's available pipeline capacity); (2) a large gas consumer with pipeline capacity priority reduces the amount of short-term pipeline capacity available; and (3) pipeline capacity uncertainty exists, and both of the former pipeline scenarios can occur with equal probability. The uniform probabilities assigned to these two scenarios were selected arbitrarily for demonstration, and in reality scenario probabilities would reflect either a firm or a regulator's best estimates based on expertise.

#### Long-term pipeline transportation purchases

Figure 3-14 shows the impact of pipeline shortages and uncertainty on the firm's long-term pipeline transportation decisions. When there is no chance of a shortage, the firm buys the least amount of pipeline capacity relative to the other two scenarios and

completely quits after a specific price threshold (note that the vertical scale for the top chart is about one-third of the scale of the other two charts). However, as shown in the middle chart, when the firm's access to pipeline capacity varies depending on the demand of another gas consumer, the firm is willing secure a greater amount of firm transportation. When the firm does not know which gas scenario will occur, it purchases an intermediate amount of long-term pipeline transportation relative to the two deterministic cases. Interestingly, the possibility of not experiencing any gas shortages substantially attenuates the firm's transportation purchases, reducing both the previous "plateau" near \$100/MMBtu and the firm's corresponding forward capacity offer (see Figure 3-17). Although this result may minimize costs/maximize profits in expectation, depending on which scenario actually occurs, the electric power system will experience either no gas pipeline shortage or substantial gas pipeline shortage—not an "in between" mixing of these two possibilities. Section 3.3.2 explores modeling risk aversion to pipeline shortages and how this risk aversion can affect firm transportation purchases.

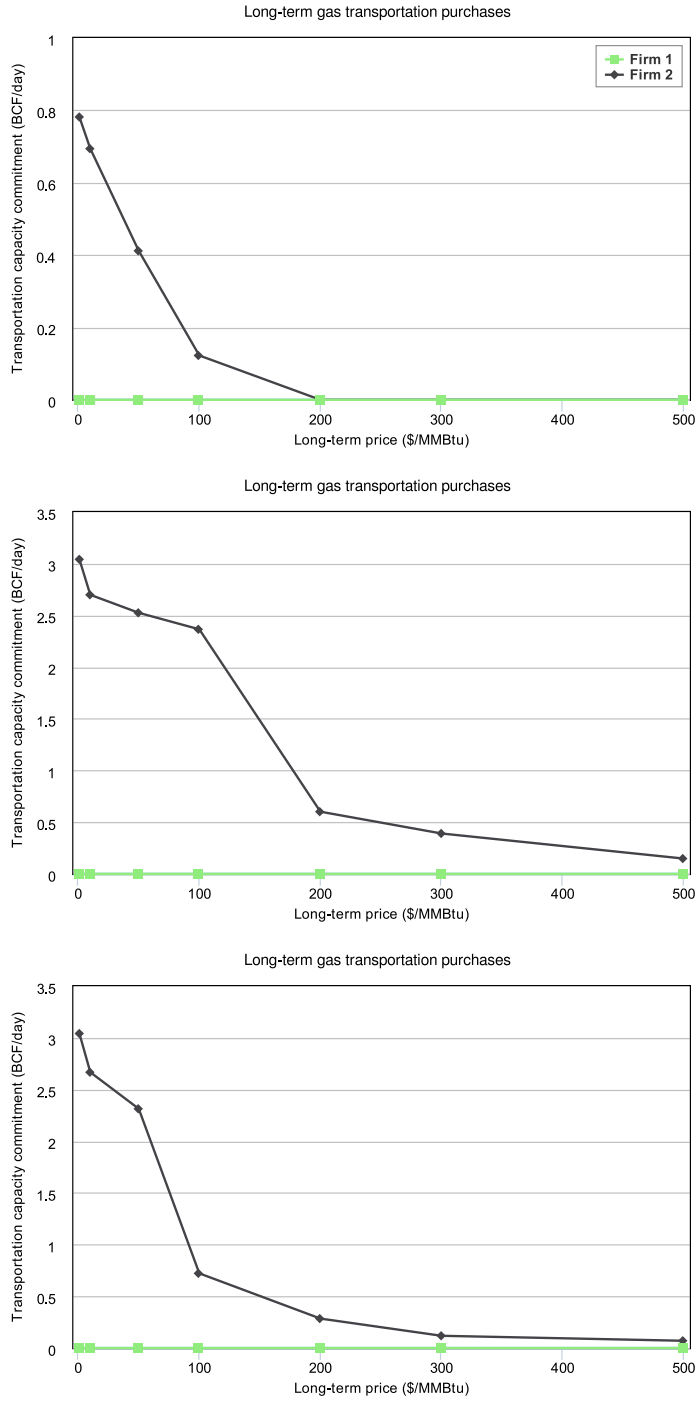

Figure 3-14: Long-term gas purchase, all decisions enabled: (top) no transportation cost; (middle) pipeline scarcity; (bottom) gas uncertainty



## LTSA selection

Figure 3-15 shows firm 2's long-term service agreement decisions under different long-term pipeline transportation prices and pipeline availability scenarios. For these runs, the less flexible contract offers 25,000 firing hours and 250 starts for \$10 million, while the more flexible contract offers 25,000 firing hours and 750 starts for \$20 million.

When there is no pipeline capacity shortage, the firm overwhelmingly prefers the less flexible contract—more of the firm's plants can operate as base load/intermediate units that cycle relatively infrequently, and the extra starts are less useful for most plants. In the pipeline capacity shortage scenario, the plants are almost split evenly between both contracts as the price of long-term pipeline transportation increases, suggesting that the firm operates more of its plants as peakers compared to the no pipeline capacity shortage scenario. Interestingly, when gas pipeline capacity uncertainty exists, the firm substantially prefers the more flexible contract as long-term pipeline transportation prices rise. The extra flexibility allows the firm to operate its power plants as either baseload or peaker units depending on which future actually occurs, and the trade-off in cost, given this particular set of input data, is worth the added flexibility.

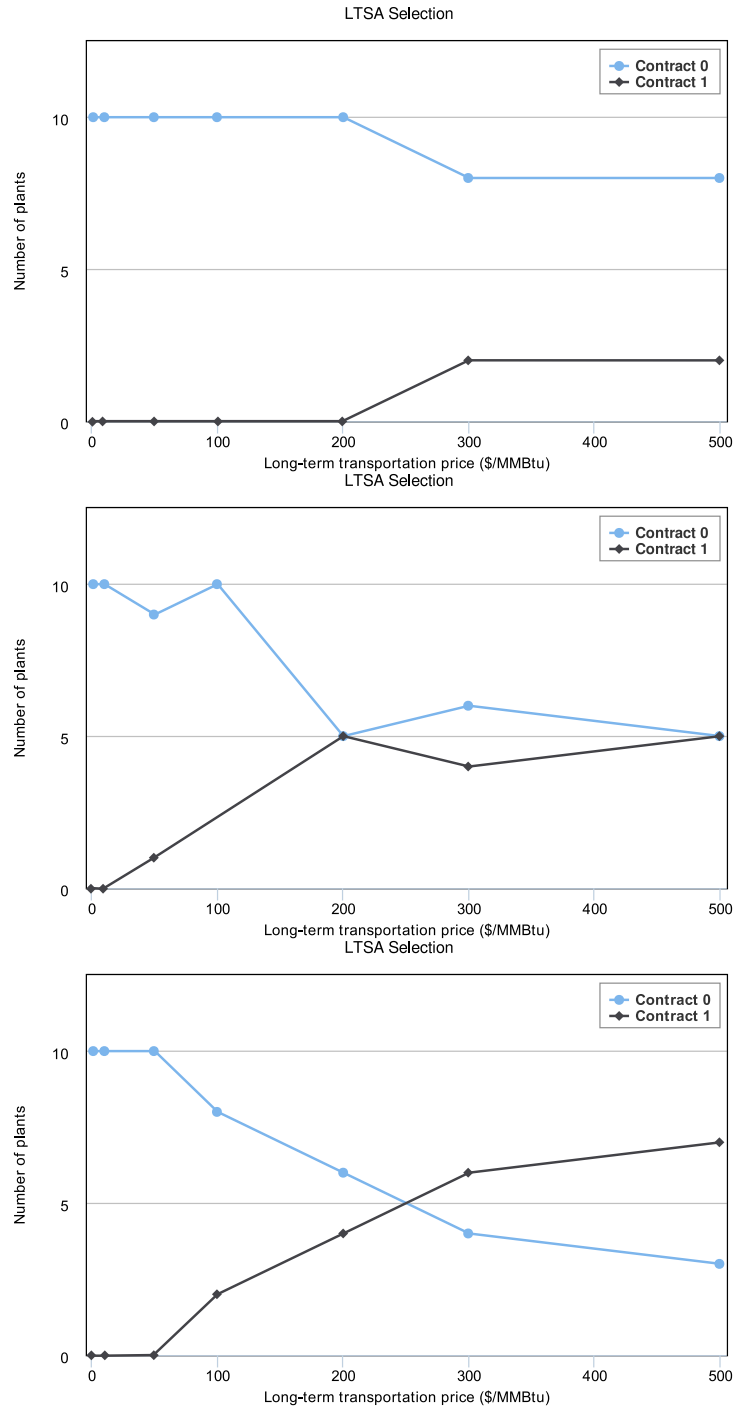

Figure 3-15: LTSA, all decisions enabled: (top) no transportation cost; (middle) pipeline scarcity; (bottom) gas uncertainty

## Maintenance schedule

Figure 3-16 illustrates available gas-fired power plant capacity throughout the year for different long-term pipeline transportation prices. Because higher long-term pipeline transportation prices tend to drive down gas consumption (as previously observed in Figure 3-9, all else being equal), exploring how maintenance schedules compare across different long-term pipeline transportation prices may reveal whether substantial maintenance pattern differences exist when a firm operates its power plants as base loaded units or as peakers.

The firm shown in these charts owns 20,000 MW of gas-fired power plant capacity. Out of all pipeline scenarios, at most, the firm only simultaneously takes two plants (4000 MW) of capacity offline. The consistent “empty” maintenance areas around January and the summer months in all three pipeline scenarios match empirical observations that firms should schedule maintenance during the spring and fall, when demand and electricity prices are typically lower than other times of the year. The consistency between all three maintenance schedules suggests that it is advantageous for the firm to spread out its maintenance across the early spring and fall months in this system, keeping as much of its capacity online as possible during the summer and winter

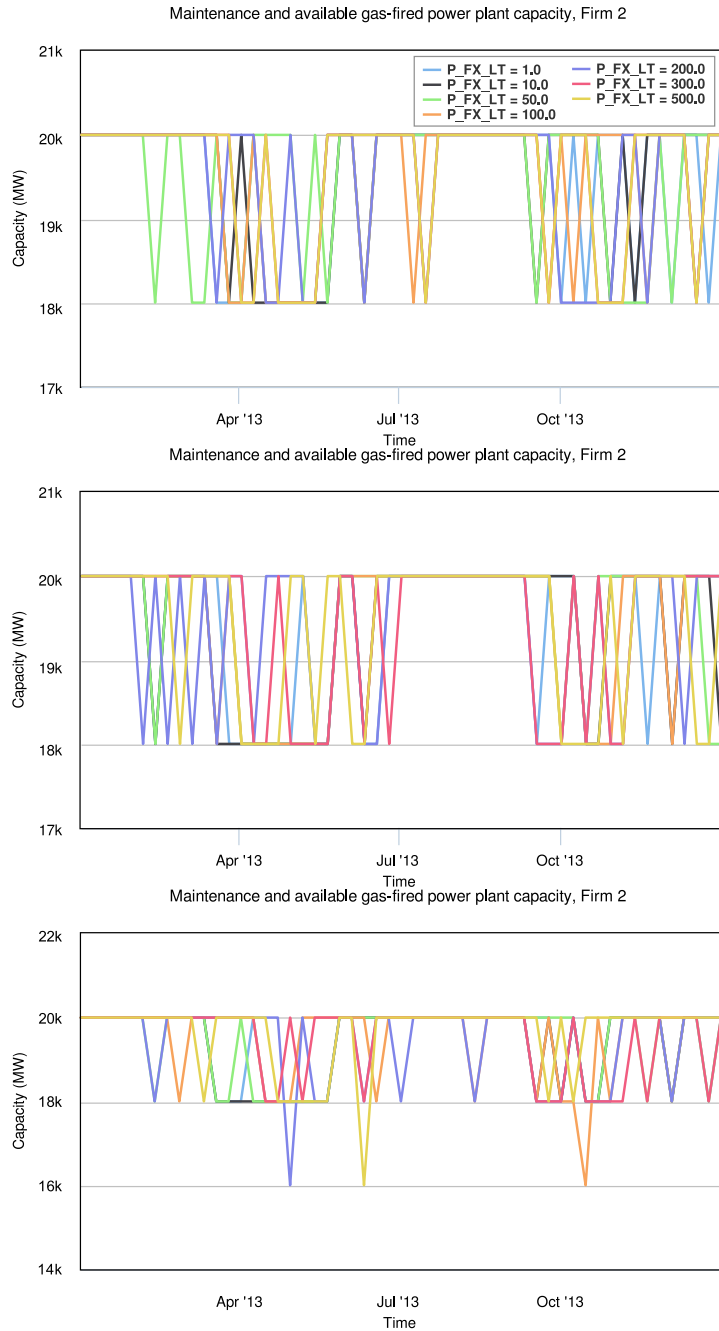

Figure 3-16: Maintenance schedule, all decisions enabled: (top) no transportation cost; (middle) pipeline scarcity; (bottom) gas uncertainty

### Forward capacity commitment

Figure 3-17 shows forward capacity commitments over a range of long-term pipeline transportation prices for each pipeline scenario. Surprisingly, in both deterministic cases—when there is no possibility of a shortage, and when shortages will occur with

certainty—firm 2 contributes a consistent amount of capacity. Yet, when the firm is uncertain about future gas availability, its forward capacity contribution sharply drops as the price of long-term pipeline transportation rises, and coal makes up the difference. In the uncertainty scenario, as the price of long-term pipeline transportation increases, acquiring forward capacity from coal technologies becomes cheaper than acquiring forward capacity from gas technologies because the firm may pay more than it needs for transportation if the no-shortage scenario occurs, and the firm *must* purchase long-term pipeline transportation to ensure that it has adequate gas supplies for its forward capacity offer. Therefore, interestingly, the welfare-maximizing choice is for the firm with gas-fired power plants to offer less in the forward capacity market and to allow the coal plant to make up the remainder.

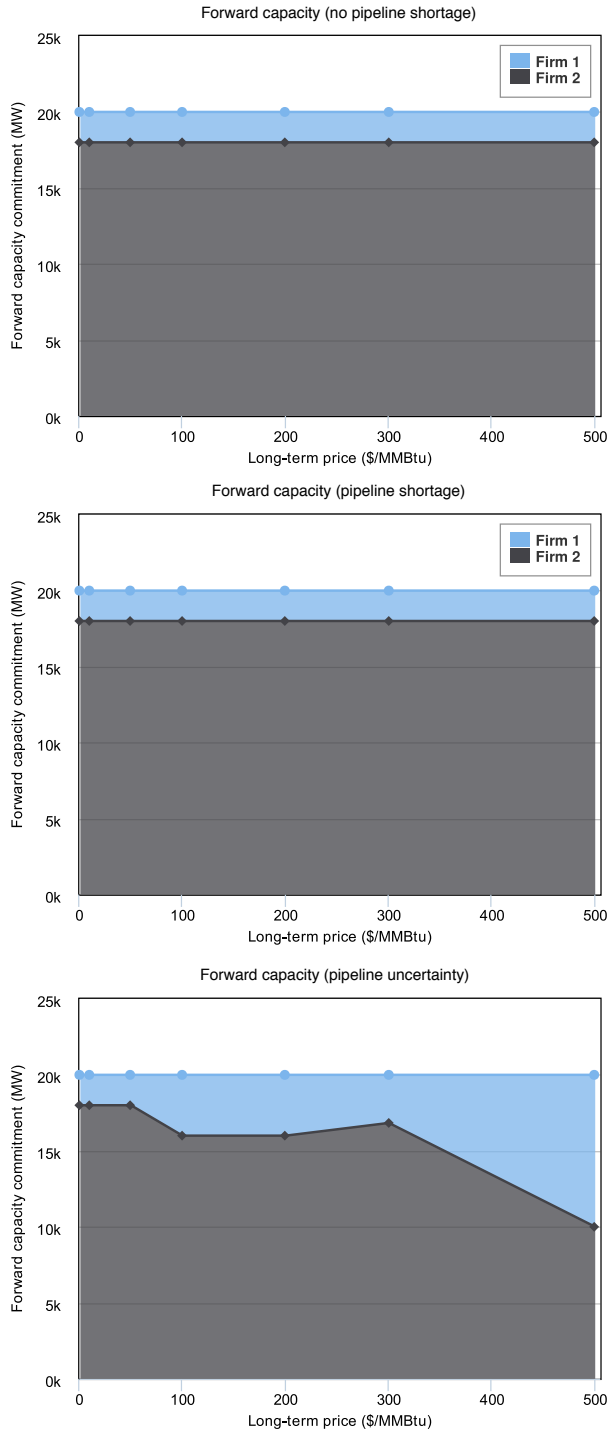

Figure 3-17: Forward capacity, all decisions enabled: (top) no transportation cost; (middle) pipeline scarcity; (bottom) gas uncertainty

### 3.3 Hypothetical explorations

After having reviewed decisions in isolation as a common-sense check on the model’s implementation, and after having reviewed decisions made simultaneously under uncertainty to gain greater insight about how decisions interact with one another, we now turn to analyze a full-sized power system based on the New England input data previously described in section 3.1. The pipeline connected to this power system can transport 2.6 BCF of natural gas per day, which mirrors the available capacity at Algonquin into New England. As before, this model of New England is a single-node market that does not represent the transmission or the gas network. Given that New England’s primary pipeline scarcity problems occur due to lack of adequate capacity at Algonquin and not the other smaller pipelines that feed into the region, we expect this single-node representation to be a reasonable abstraction.

In this power system, firms 1 through 5 collectively own 203 power plants as enumerated in ISO-NE’s 2013 Winter Seasonality Report<sup>5</sup> and summarized in Table 3.1. Five firms have been arbitrarily assigned to ownership of power plants. Broadly, firm 1 owns nuclear and coal plants; firms 2 and 3 own gas-fired power plants; and firms 4 and 5 own oil and diesel-fired power plants. In the results below, “firm 6” represents an imaginary power plant that can meet all unmet demand (nonserved energy) at a price of \$3500/MWh. This is equivalent to assigning all consumer demand a utility/price of \$3500/MWh; when the price of electricity rises above this price, the consumer stops consumption. (The existing academic literature typically assigns nonserved energy a value between \$2000/MWh and \$5000/MWh; in [LaFleur et al., 2014a], other agencies have used values that are an order of magnitude higher.)

#### 3.3.1 Full-sized power system

We start by presenting the decisions that each firm should make given ISO-NE’s electricity demand (Figure 3-2) and gas prices (Figure 3-5), and then analyze how these decisions might change after introducing electricity demand and pipeline uncertainty.

---

<sup>5</sup>[http://www.iso-ne.com/genrtion\\_resrcs/snl\\_clmd\\_cap/2013/index.html](http://www.iso-ne.com/genrtion_resrcs/snl_clmd_cap/2013/index.html)

As before, for many of these explorations, we analyze a decision’s sensitivity to the price of long-term pipeline transportation because this price and the corresponding quantity purchased by each firm can reveal useful interactions that may signal a dependency or an investment opportunity for new entrants.

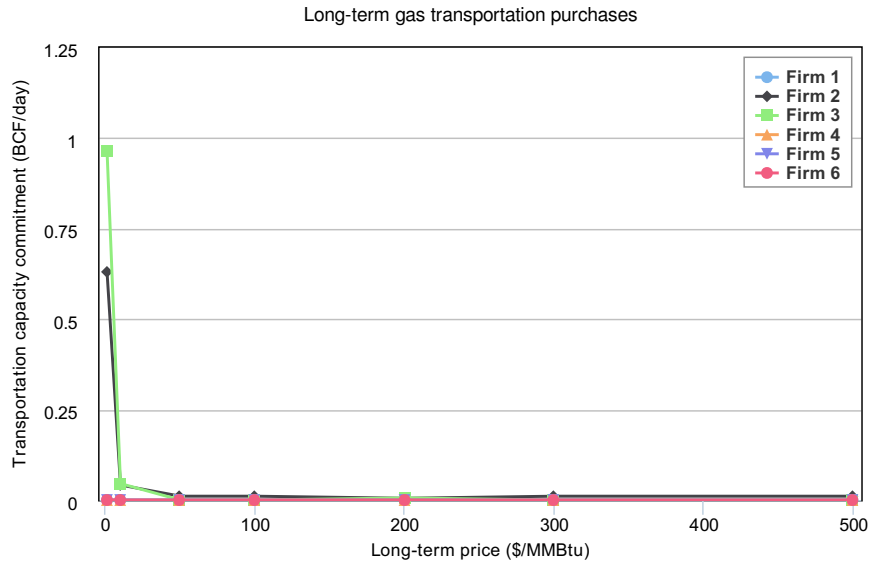

Figure 3-18: Long-term gas purchase, full power system

For the deterministic scenario described at the beginning of this section, Figure 3-18 illustrates the long-term pipeline transportation purchases that all firms make for prices ranging between \$1/MMBtu/day to \$500/MMBtu/day. As only Firms 2 and 3 own gas-fired power plants in this system, no other firms require nor purchase long-term pipeline transportation. In contrast to the purchasing patterns observed in the “toy” power system (see Figure 3-8), in this full-sized power system, an increase in the cost of long-term gas transportation leads to a sharp decline in the optimal purchase quantity. Even long-term prices of \$10/MMBtu produce little investment in long-term pipeline transportation, despite high winter prices near \$40/MMBtu.

The sharp decline in demand for gas transportation as prices increase in Figure 3-18 demonstrates one of the strengths of studying a firm’s behavior with mathematical modeling: although intuition alone yields an inverse relationship between the price of long-term pipeline transportation and the quantity demanded, intuition does not



necessarily describe what functional form the relationship between transportation and prices might take. For this particular power system and input data, taking into consideration all of the decisions and constraints described in Chapter 2, we can observe that a small price increase can create a substantial decline in the quantity of long-term pipeline transportation demanded.

We expect and observe, in Figure 3-19, that firms should make a trade off between long-term costs and expected short-term costs when purchasing long-term pipeline transportation. The dark blue in Figure 3-19 shows firm 2's long-term pipeline transportation purchase, while the light blue indicates the firm's actual natural gas consumption and the additional pipeline capacity that the firm must acquire in the short term. In the top chart, when long-term pipeline transportation is inexpensive, the firm trades off between long-term and spot markets by buying long-term pipeline transportation in excess of the amount that it needs on days when the firm burns little natural gas. In the middle chart, when the price of firm transportation rises to \$10/MMBtu/day, demand for long-term pipeline transportation falls substantially as prices increase, and the firm never buys long-term pipeline transportation in excess of what it needs on a daily basis within the year. Comparing the top and middle charts, the firm's overall consumption of natural gas also decreases as the price of long-term pipeline transportation increases. This result occurs because as long-term prices increase, the firm's overall costs increase relative to other technologies. Rather than dispatch expensive gas-fired power plants, the power system begins to substitute generation from less expensive technologies, suppressing total gas consumption.

In addition to the interplay between long- and short-term pipeline capacity decisions, we can also observe the impact of this system's gas-centric capacity mix on long-term pipeline transportation in Figure 3-19. As shown in the bottom chart, despite the sharp decline for long-term pipeline transportation as prices increase, firm 2 still acquires a small amount of long-term pipeline transportation even as prices increase by an order of magnitude. Relative to the value of loss load, it remains welfare-maximizing for firm 2 to secure a small amount of firm capacity to ensure that it has adequate pipeline capacity in the winter months. This purchase high-

lights both how heavily gas-dependent the current power system is and a potential opportunity for new entrants.

Fuel usage, Firm 2, P\_FX\_LT = 1 (approximation from long term)

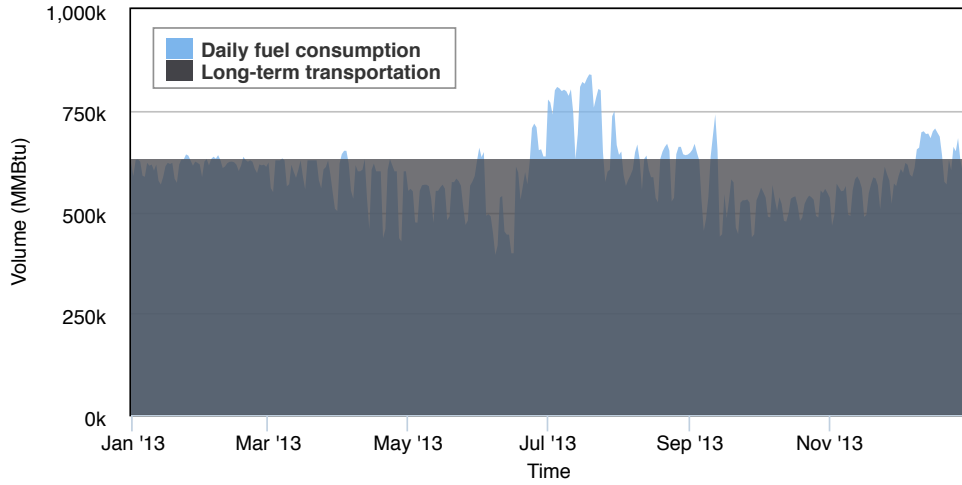

Fuel usage, Firm 2, P\_FX\_LT = 10 (approximation from long term)

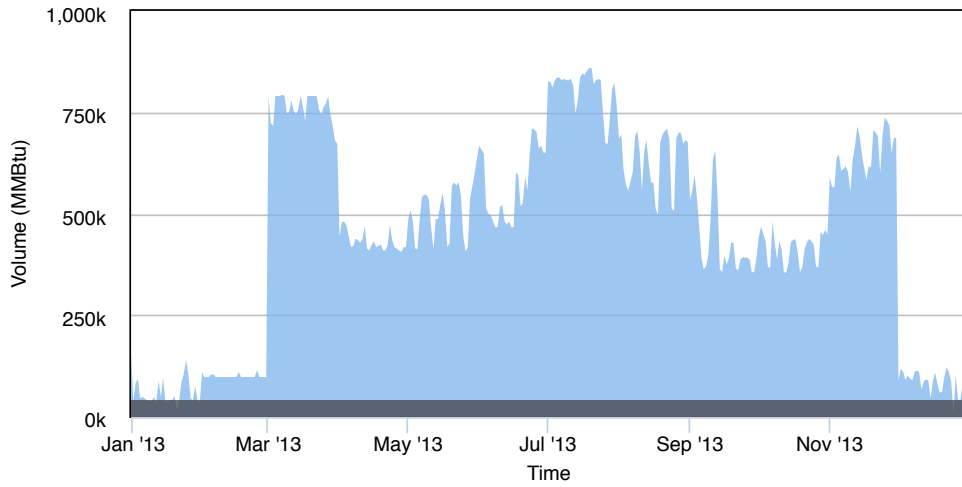

Fuel usage, Firm 2, P\_FX\_LT = 50 (approximation from long term)

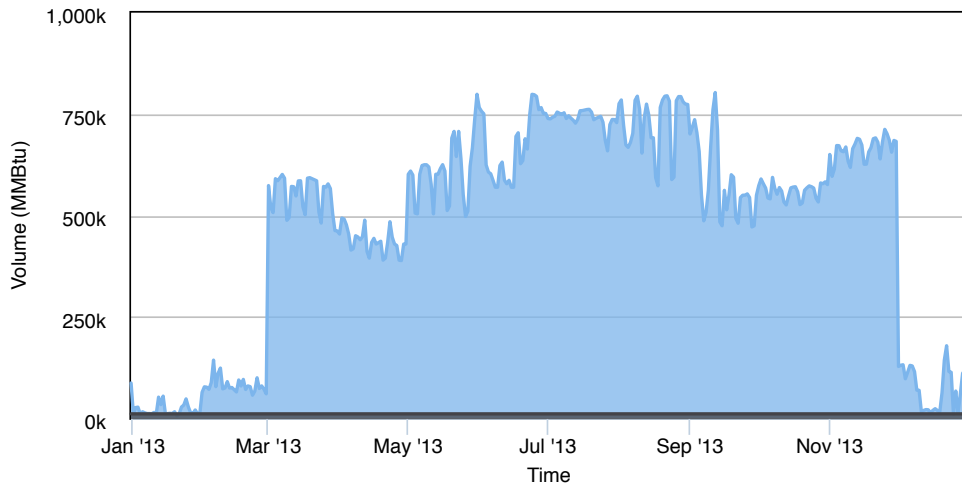

Figure 3-19: Estimated annual fuel purchases, full power system

For long-term service agreement decisions, Figure 3-20 shows the optimal number of gas-fired power plants assigned to each available contract starting “greenfield,” with no prior binding commitments. (In reality, firms in most power systems will not simultaneously make new long-term service agreement decisions for all of their power plants, and in future sections, we will fix long-term service agreements to the same contract to better reflect reality.) However, without loss of generality, the model can make long-term service agreement decisions for any number of power plants, making this tool useful for renegotiating the long-term service agreement of even a single power plant. For this case study, contract 0 carries a premium of \$10 million and allows 250 starts and 20,000 firing hours, while contract 1 carries a premium of \$20 million and allows 750 starts and 20,000 firing hours. Contract 1 allows firms greater flexibility to operate their power plants, but if firms do not use the extra flexibility, then they may end up paying more than they would under contract 0. For example, if a firm purchases the more flexible maintenance contract under the assumption that intermittent renewables investment will force its gas-fired power plants to cycle more frequently, and the investment in intermittent renewables does not emerge, then the firm will not use the extra starts that it purchased under the more flexible contract.

In general, firms in this power system tend to always prefer the more flexible contract for at least half of all of their power plants. However, for this particular power system and input data, between long-term pipeline transportation prices of \$50/MMBtu and \$200/MMBtu, firms substantially choose the less flexible and less expensive contract due to the following reasons. First, as long-term prices increase, gas-fired power plants become less economically competitive with non-gas technologies. Second, as power plants cycle more frequently, the more flexible contract becomes less expensive per unit start. Because a gas-fired power plant’s costs comprise both its fuel and its operations and maintenance costs, for this particular power system and deterministic input data, the two available contracts are similar enough that although firms tend to prefer the more flexible contract as long-term pipeline transportation prices increase, when firm transportation ranges from \$50/MMBtu/day to \$200/MMBtu/day, operational costs for as many as 10 gas-fired power plants

are quite similar regardless of which service agreement they operate under. Table 3.5 compares relevant details for a representative power plant when the price of long-term pipeline transportation is \$50/MMBtu, \$100/MMBtu, and \$300/MMBtu to confirm that other important decisions remain largely unchanged. Given the similarity of cost trade-offs within these prices, the solver picks the first set of service agreements found that meets the MILP tolerance (in this case, a relative tolerance of 0.005), resulting in the local minimum and maximum that appears at \$100/MMBtu for both contracts. Overall, as firm transportation prices rise and gas consumption decreases (see Figure 3-19), firms in this system prefer the more flexible service agreement.

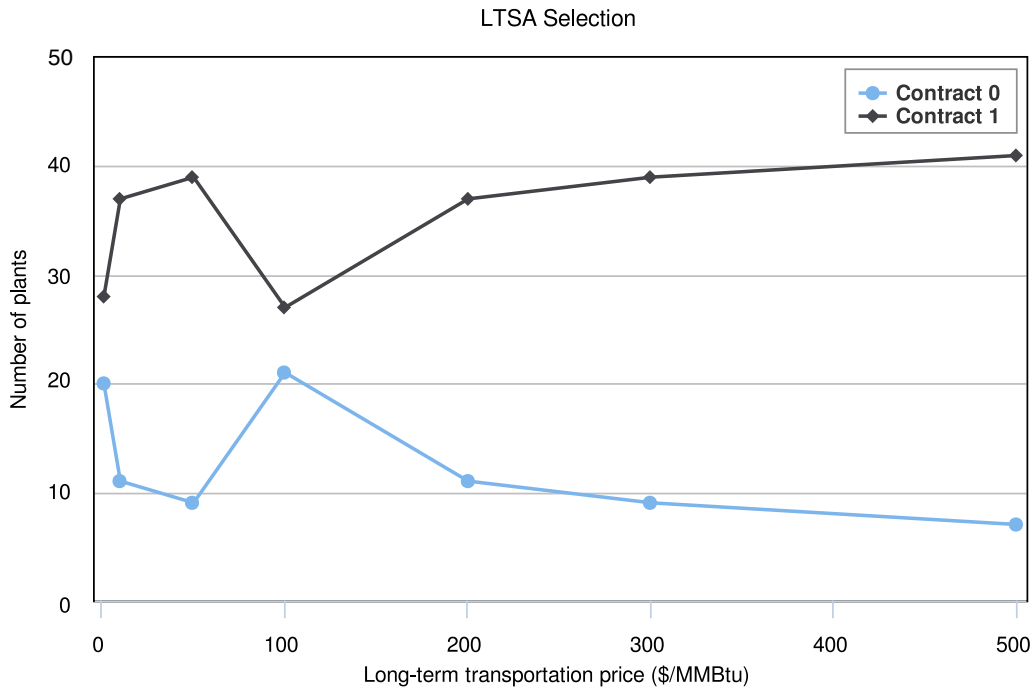

Figure 3-20: LTSA selection, full power system

transportation price (\$/MMBtu)	LTSA contract	starts	firing hours	maintenance costs (\$)
50	1	139	6950	5.6 million
100	0	134	6077	5.4 million
200	1	145	6344	5.8 million

Table 3.5: LTSA/long-term pipeline transportation operations and costs comparison for a representative power plant

Figure 3-21 shows the aggregate gas-fired power plant capacity available for Firm 2, and Figure 3-22 shows the the aggregate gas-fired power plant capacity available for Firm 3 across a range of long-term pipeline transportation prices based on each firm’s optimal maintenance schedule throughout the year. Consistent with the trends observed in the isolated decisions experiments, firms should generally take their plants offline in the late spring and early fall and keep as much capacity available as possible during the summer months.

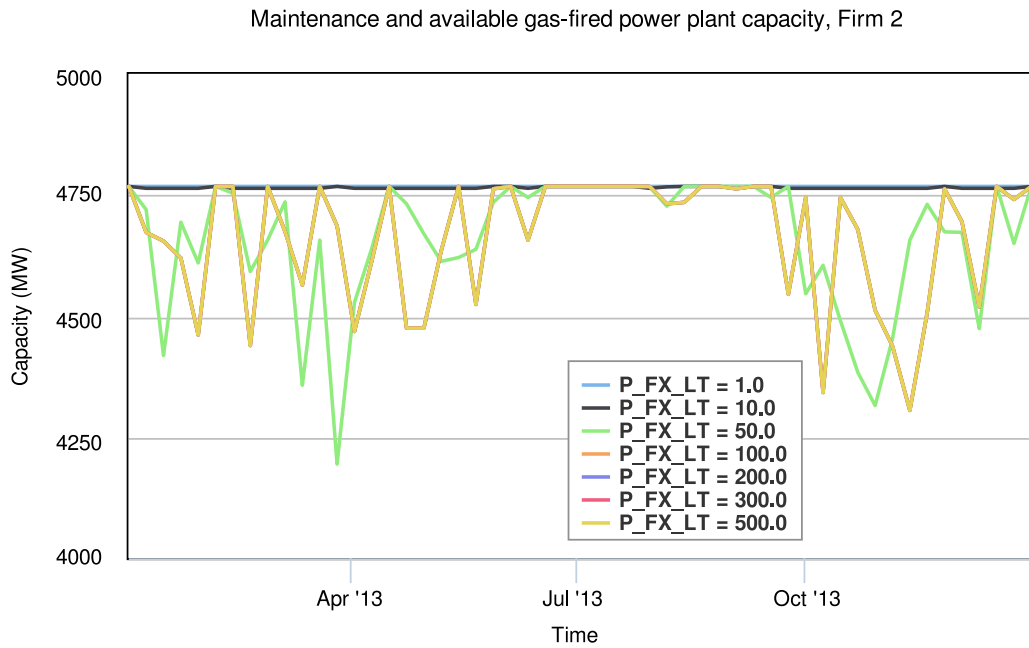

Figure 3-21: Maintenance schedule, Firm 2

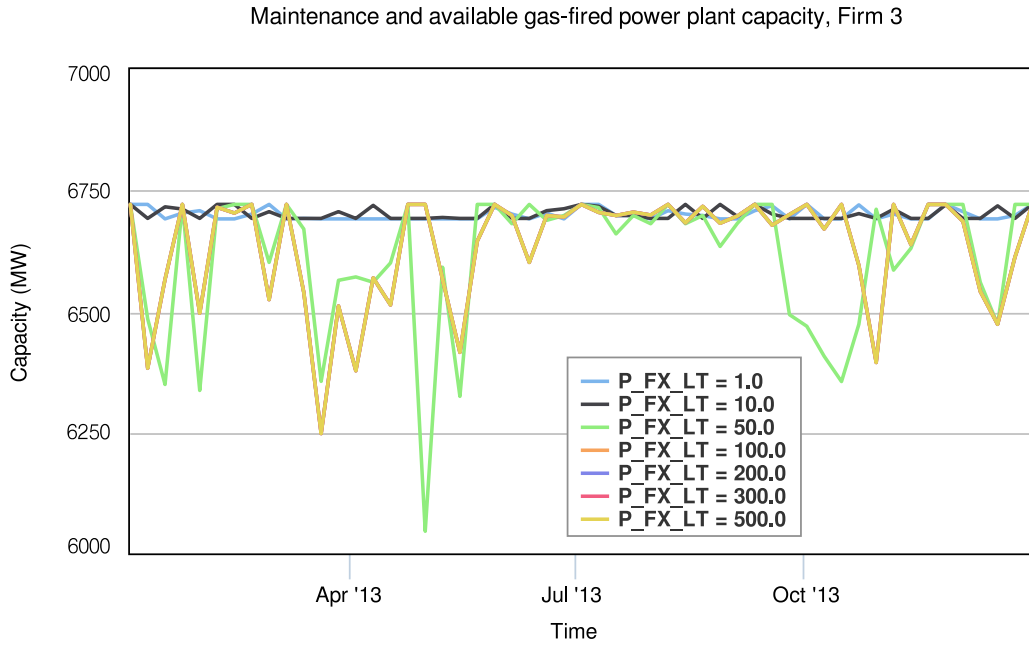

Figure 3-22: Maintenance schedule, Firm 3

However, a different maintenance trend emerges when the long-term pipeline transportation price is low (in Figures 3-21 and 3-22, the dark and light blue lines represent low long-term pipeline transportation prices of \$1/MMBtu and \$10/MMBtu), and firms have access to more natural gas: rather than clump maintenance together in the late spring and early fall, which leads to periods of relatively low and high gas-fired power plant capacity, firms should spread out their maintenance evenly throughout the year and maintain a consistent level of availability. We can observe the generation differences corresponding to these distinct maintenance patterns in Figures 3-23 and 3-23, which aggregate the amount of energy produced by Firms 2 and 3 on a weekly basis throughout the year. When the long-term pipeline transportation price is low and gas transportation is not scarce (Figure 3-23), Firms 2 and 3 consistently generate more energy throughout the year than when the long-term pipeline transportation price is high and firms have less access to gas transportation (Figure 3-24). The two distinct maintenance schedules observed in Figures 3-21 and 3-22 support each firm's operations dependent on other inputs to the gas and power system, such as the long-term pipeline transportation price and the amount of long-term pipeline transportation capacity that each firm purchases.

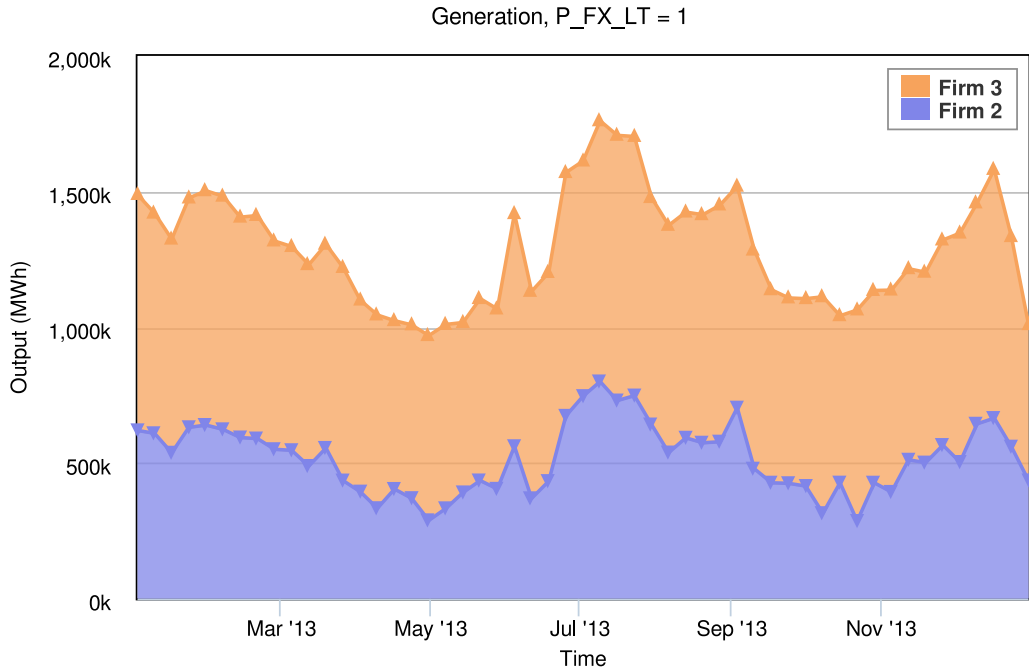

Figure 3-23: Weekly energy output, long-term pipeline transportation price: \$1/MMBtu

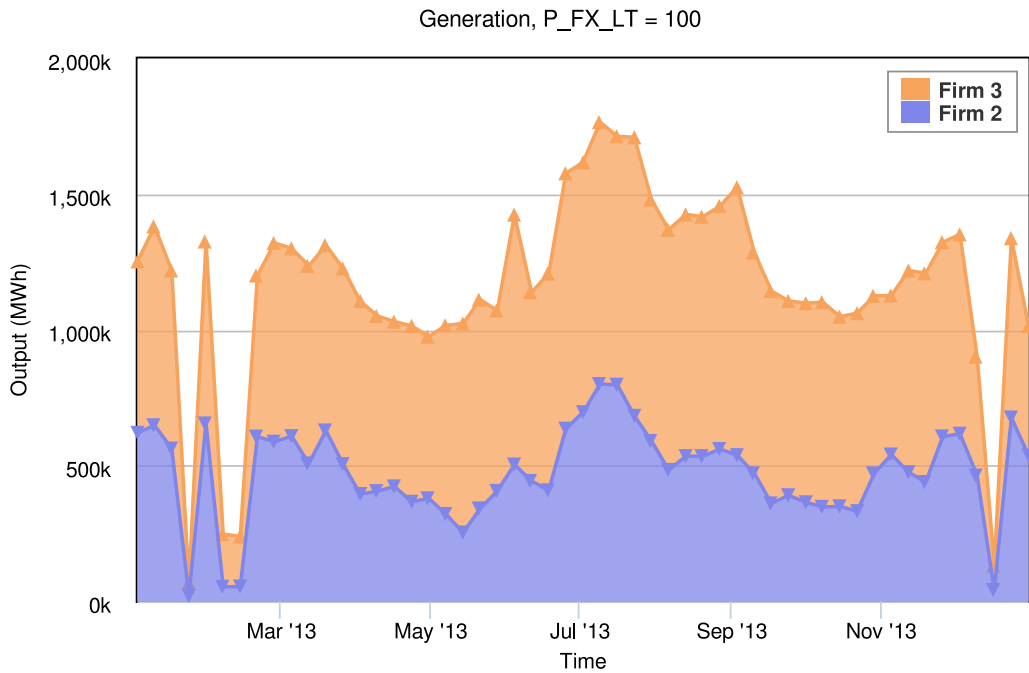

Figure 3-24: Weekly energy output, long-term pipeline transportation price: \$100/MMBtu

Turning to the remaining annual decision, Figure 3-25 shows the forward capacity commitments for each firm across a range of long-term pipeline transportation prices,



and Figure 3-26 shows the corresponding forward capacity profits for each firm. For this case study, the system operator sets a forward capacity target of 20,000 MW. We calculate profits by multiplying each firm’s final forward capacity commitment with the dual variable of the forward capacity constraint in Equation 2.71. As with long-term pipeline transportation decisions, the broad trends are not surprising—as the price of long-term pipeline transportation increases, and firms have less guaranteed access to pipeline capacity because they must rely more on the spot market, their forward capacity commitments decrease. However, as with long-term pipeline transportation, the functional relationship between long-term pipeline transportation prices and the forward capacity contributions of gas-fired technologies is nonlinear and drops sharply with the price of long-term pipeline transportation. Given that gas-fired power plants constitute one-third of all power plant capacity in this system, the sharp decline suggests that at long-term pipeline transportation prices reflecting the upper-bound of short-term prices in 2013, other technologies can provide forward capacity at less cost than natural gas.

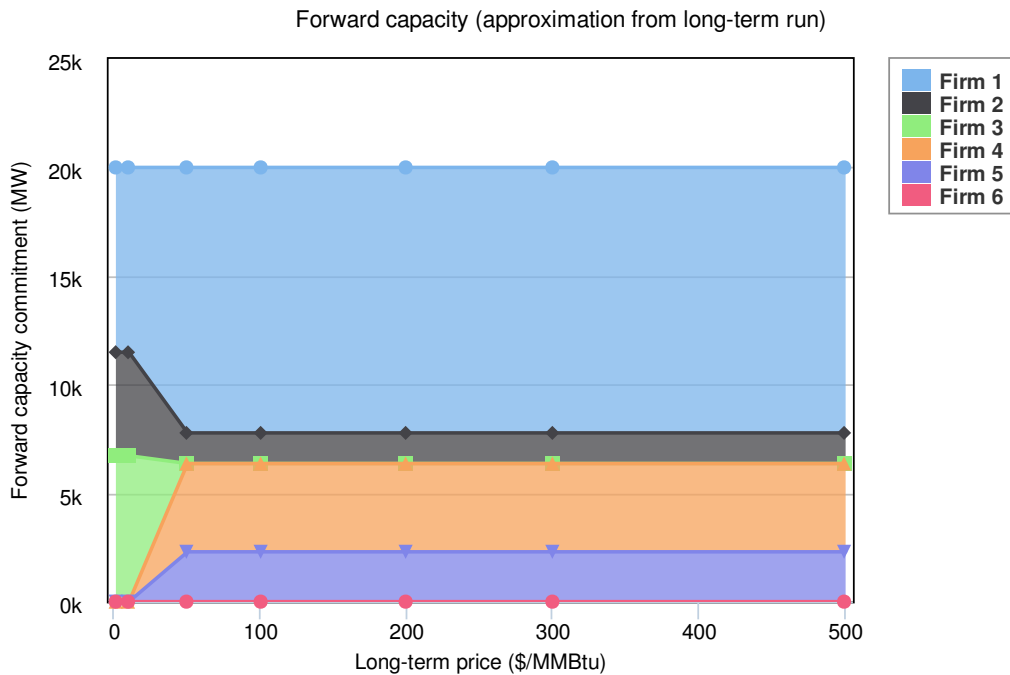

Figure 3-25: Annual forward capacity commitments

The corresponding forward capacity profits shown in Figure 3-26 tell a similar story. The baseload plants owned by Firm 1 earn the lion's share of forward capacity profits, and other non-gas-fired technologies quickly displace gas-fired power plants as the price of long-term pipeline transportation increases. Of all of the firms in the power system, gas-fired power plants earn the least amount from the forward capacity market as long-term pipeline transportation prices increase.

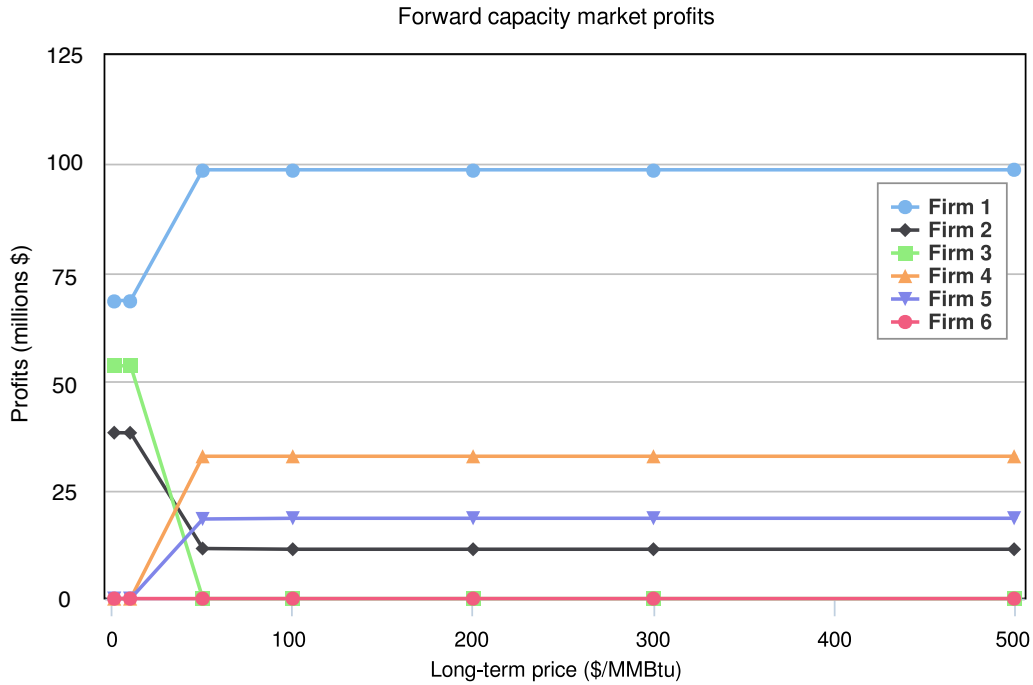

Figure 3-26: Annual forward capacity profits

Lastly, for comparison to the forward capacity market profits, Figure 3-27 shows the corresponding energy market profits for each firm over the same range of long-term pipeline transportation prices. We calculate energy profits as the revenue that each firm collects based on their generation level and the dual variable of the demand constraint (Equation 2.94) less all nonconvex costs (starting, stopping, and no-load), fuel costs, and operations and maintenance costs. Again, the baseload plants owned by Firm 1 take in the lion's share of profits. However, unlike in the forward capacity market, both firms that own gas-fired power plants continue to make money as the price of long-term pipeline transportation increases. Interestingly, expensive long-

term pipeline transportation initially lifts the inframarginal rents of all firms in the power system until prices reach approximately \$100/MMBtu. Afterward, the cost of operating gas-fired power plants increases enough to allow other technologies to become economically competitive, leveling off the amount of transportation that firms commit to.

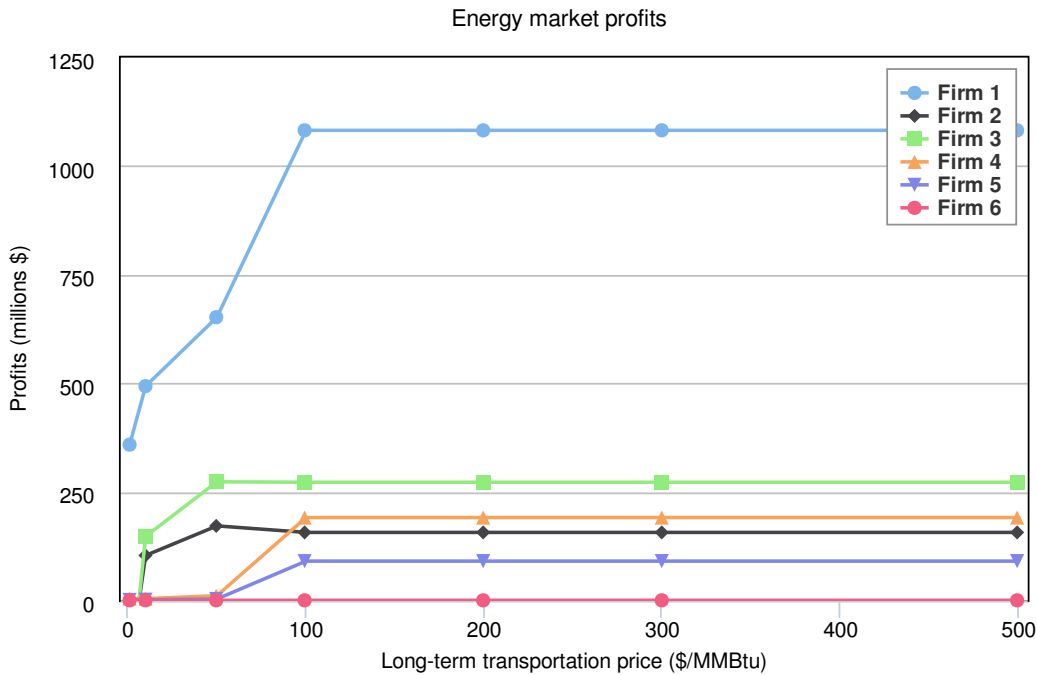

Figure 3-27: Annual energy profits

### 3.3.2 Explorations under uncertainty

For the remaining parts of the case study, we will introduce pipeline availability and electricity demand uncertainty and explore firm transportation and forward capacity market decisions. In total, this section will introduce six possible future scenarios that combine three different electricity demand possibilities with two different gas transportation possibilities. Benchmark scenarios, as previously noted, are based on data from ISO-NE and EIA. New scenarios were arbitrarily created to mimic constant and peak demand growth, as well as to represent normal and below-average temperature years. The three electricity demand scenarios consist of 1) the benchmark case shown in Figure 3-2; 2) a demand growth case that adds an additional base load

demand of 2000MW to every hour; and 3) a “peak” demand growth case that adds 10% additional demand to every hour in the benchmark case. The two gas scenarios consist of 1) the benchmark scenario shown in Figure 3-5, which represents a “bad weather” year with large demand for heating; and 2) a congestion-free scenario with no transportation costs to represent a “good weather” year. For these explorations, we only consider a single long-term pipeline transportation price of \$10/MMBtu/day, which strikes a balance in between 2013’s historical range of short-term transportation prices from \$0/MMBtu/day to just under \$40/MMBtu/day. Table 3.6 summarizes these six uncertainty scenarios.

elec. index	gas index	description
1	1	Benchmark electricity and gas demand
2	1	Benchmark demand + 2k constant load; benchmark gas demand
3	1	1.1x benchmark electricity demand; benchmark gas demand
1	2	Benchmark electricity demand; no pipeline congestion
2	2	Benchmark electricity demand + 2k const. load; no pipeline congestion
3	2	1.1x benchmark electricity demand; no pipeline congestion

Table 3.6: Gas and electricity uncertainty scenarios

Using the uncertainty scenarios just described, we will explore how firms may consider 1) risk aversion to not having enough pipeline transportation to meet gas consumption; 2) risk premiums for unexpected forced plant outages when bidding in forward capacity markets; and 3) risk premiums for forward capacity performance penalties and incentives. In the last two sections, we introduce a method for evaluating forced outages and unmet capacity obligations based on probabilistic production cost methods that regulators and researchers have traditionally applied to power systems for reliability analyses.

### Forward capacity bidding

Prior to February 2015, ISO-New England’s forward capacity market empirically did not lead to improved power plant availability during times of high electricity demand

and supply scarcity. Many participants in market restructuring discussions noted that ISO-New England’s old forward capacity market carried penalties that were too weak, and the defined commodity was based on only capacity, not real-time performance. To address the short-comings of its old forward capacity market, ISO-New England updated its market design using a “pay for performance” scheme that FERC approved in June 2014.

In this new market design, buyers (consumers) initially pay the costs of the forward capacity auction. The forward capacity auction operates with a reverse-auction mechanism. All firms receive the clearing price multiplied by their forward capacity obligation, and this payment marks the first of two settlements. For the second settlement, as shortage events occur in real time, firms that are unable to meet their capacity obligations pay for deviations based on the forward capacity auction *starting* price—not the clearing price. Firms that are able to exceed their capacity obligations and firms that perform but did not initially win an obligation in the forward capacity market receive the money collected from under-performing firms. As the starting price is greater than or equal to the clearing price, firms can lose more money than they earned in the forward capacity market if they are unable to perform during shortage events. Currently, ISO-NE caps an individual firm’s loss at three times its annual forward capacity obligation multiplied by the forward capacity auction’s starting price. As the starting price is known prior to the first bid, firms can measure with certainty their absolute risk when deciding how to bid in the forward capacity market. [LaFleur et al., 2014a]

Chapter 4 analyzes in greater detail the various social, economic, and regulatory challenges that designing forward capacity markets pose. With respect to the model formulation presented in Chapter 2, no change is required to accommodate ISO-NE’s two-stage settlement process. The formulation as is currently accounts for the initial cost that consumers pay (in particular, the costs required for firms to acquire natural gas transportation and maintain their power plants), and penalties and credits that exchange hands in the second settlement are transacted solely between firms and cancel out in the welfare equation.

However, for any particular firm, penalties and credits related to availability can change the profit that each firm earns, even when the power system's overall welfare remains the same. For risk-neutral firms, we would expect their forward capacity contributions to mirror the central planner's solution. For risk-averse firms, we would expect the central planner's solution to reflect an upper-bound on each firm's contribution to the forward capacity market and a lower-bound on each firm's forward capacity bid. By using the risk constraints presented in Section 3.3.2, we can estimate how much additional long-term pipeline transportation a risk-averse firm might purchase (relative to a risk-neutral firm) to guarantee its gas transportation needs. Using a heuristic technique developed in this dissertation based on probabilistic production cost algorithms, we can also estimate the risk premium that firms will likely include in their forward capacity bids based on the expected forced outage rates for each power plant and estimates of marginal electricity prices throughout the year.

To determine forward capacity market bids, we compare a firm's annual costs after solving the full system state model once with a forward capacity target of 20k MW, and once with a forward capacity target of 0 MW and forcing all forward capacity commitment variables to zero. The difference in operation costs for each firm between these two runs represents the cost of providing forward capacity. Table 3.7 shows the operations, start-up/shut-down/no-load, fuel, and long-term pipeline transportation costs for one of the two firms that owns gas-fired power plants with and without the forward capacity market.

	with forward capacity market	without forward capacity market	difference
nonconvex costs (\$)	510 million	530 million	-20 million
fuel costs (\$)	1,300 million	920 million	380 million
operations costs (\$)	87 million	97 million	-10 million
long-term trans. (BCF)	0.12	0.02	0.10
committed capacity (MW)	700	-	-
available capacity (MW)	4768	-	-

Table 3.7: Firm 2’s forward capacity market bid information (\$10/MMBtu/day firm transportation)

The fourth column in Table 3.7 calculates the difference between the firm’s costs with and without a forward capacity market. The net difference represents the impact of the forward capacity market on the firm’s costs. For some costs, such as the start-up/shut-down/no-load costs that were aggregated into the “nonconvex costs” column, the difference can be negative because the presence or absence of the forward capacity market can change fuel decisions for firms, which in turn impacts the generation decisions for individual power plants. The largest cost component difference between the two scenarios is the cost of long-term pipeline transportation. In the forward capacity market scenario, the firm purchases an additional 97,964 MMBtu at \$10/MMBtu/-day, resulting in an additional cost of \$320 million. For comparison, the firm’s total firm transportation in the forward capacity market scenario is approximately 5% of the entire pipeline capacity at Algonquin.

When a firm purchases long-term pipeline transportation, in this model its opportunity cost for that capacity is zero once purchased because there are no other consumers to sell to. In reality, firms can sell unused portions of their long-term pipeline transportation. However, generally the only other consumers available are other generation firms because utilities and industrial consumers historically have secured enough firm transportation to meet their expected peak demand (and generation firms have met their own transportation needs by purchasing excess capacity from utilities and industrial consumers on a short-term basis). In a perfectly competi-

tive electricity market where all generation firms have access to the same information, we would expect the most efficient generation firms to acquire their own long-term pipeline transportation and for only minimal trading to take place between generation firms (e.g., to release unused capacity during forced outages).

Given this information, we can estimate the firm’s forward capacity market unit bid by summing the net cost differences and then dividing by the firm’s committed capacity:

$$\frac{\text{cost difference}}{\text{committed capacity}} = \frac{\$320 \text{ million}}{700 \text{ MW-year}} = \frac{\$455,097}{\text{MW-year}} = \frac{\$38.15}{\text{kW-month}} \quad (3.2)$$

For comparison, in ISO-NE’s forward capacity auction for 2017 (under the old market rules), the reverse auction started at \$15.82/kW-month and stopped at \$15.00/kW-month. New entrants earn \$15.00/kW-month starting in 2017, but existing facilities only earn \$7.025/kW-month. [ISO-New England, 2014a] The estimated bid in this case study suggests that forward capacity prices may need to be anywhere between twice to four times as high as they currently are to incentivize firms with gas-fired power plants to commit to firm transportation.

### **Forward capacity market physical obligation risks**

The costs in Table 3.7 represent sums of costs from individual power plants. To determine the risk premium for this bid due to forced outages, we can use each individual power plant’s historical forced outage rate to calculate an inverted cumulative probability distribution (CDF) that describes the fraction of its forward capacity obligation that a firm is unlikely to be able to supply. This approach is directly analogous to treating the forward capacity obligation as load and applying the probabilistic production algorithm originally pioneered by [Baleriaux et al., 1967] and [Booth, 1972]; a detailed explanation of probabilistic production cost algorithms with implementation details can be found in [Leung, 2012]. Then, we can use the estimated marginal electricity prices from the optimization to estimate how much money a firm might lose when it must make energy purchases to cover its forward capacity obligations.



Marginal electricity prices are calculated as the dual variable of Equation 2.94 divided by the duration of state  $s$  and aggregated and weighted across all uncertainty scenarios by each scenario  $q$ 's probability,  $P_q$ . For this example, Figure 3-28 shows the inverted CDF for firm 2's forward capacity obligation after applying a 5% expected forced outage rate for each power plant. This inverted CDF describes the number of hours ( $f(x) \times 8760$ ) that a firm will probabilistically not meet  $x$  MW or more of its forward capacity obligation in a year.

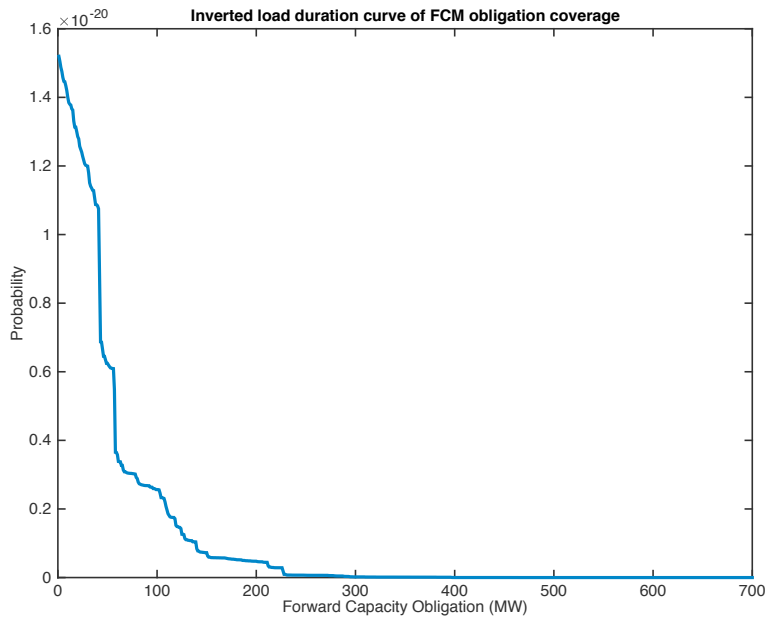

Figure 3-28: Forward capacity obligation risk

Following the interpretation of the inverted CDF/inverted load duration curve in traditional probabilistic production cost methods, the average of the forward capacity obligation values in Figure 3-28 represents the expected amount of capacity at any given instance that the firm will not be able to meet due to forced outages for one or more of its power plants. This interpretation arises from the fact that the initial inverted load duration curve was created by normalizing the time axis of the actual load duration curve. In this example, firm 2's expected unmet obligation is  $4.2e-17$  MW at any instant, and  $3.7e-13$  MWh over the course of the year. Given how small this unmet obligation is, we could stop here for practical purposes and add no risk premium to the firm's bid.

However, for the purpose of demonstrating how such a risk premium could be calculated, we continue with an examination of marginal prices and apply a technique similar to the method used in [Vázquez et al., 2002]. Figure 3-29 shows a cumulative distribution function for marginal prices in the benchmark electricity and gas scenario. If the firm were risk averse and wanted to estimate its risk premium based on the possibility of forced outages happening only during higher priced electricity hours of the year, then we can introduce a parameter  $\gamma$  that specifies an arbitrary percentage of the highest priced electricity hours that forced outages may occur over. For the risk-neutral firm,  $\gamma$  takes on a value of 0, and the firm evaluates its risk over all 8760 hours of the year. The firm can calculate its risk premium by multiplying its expected unmet obligation by the average of the hourly electricity prices described by Figure 3-29:

$$\frac{3.7 \times 10^{-13} \text{ MWh}}{\text{year}} \times \frac{\$51.71}{\text{MWh}} = \frac{\$1.9 \times 10^{-11}}{\text{year}} \quad (3.3)$$

We repeat this process for each scenario and then take a weighted average based on the probability of each scenario to determine the final risk premium to add to the bid.

Suppose, however, that the firm in this example is not risk neutral to when forced outages may occur, and instead is most concerned about the highest-priced quintile of hours. Then,  $\gamma = 0.8$ , the average hourly electricity price characterized by the CDF in Figure 3-29 increases to \$232/MWh, and the firm's estimate of its risks due to forced outages increases to \$8.58e-11. As before, we would repeat this calculation across all scenarios and then take a weighted average to determine the final risk premium to add to the bid. However, practically speaking, because the expected unmet forward obligation is so small in this example, the risk premium can simply be rounded down to zero. Figure 3-30 shows the relationship between the firm's risk aversion and the risk premium that it adds to its forward capacity bid due to forced outages for the benchmark scenario.

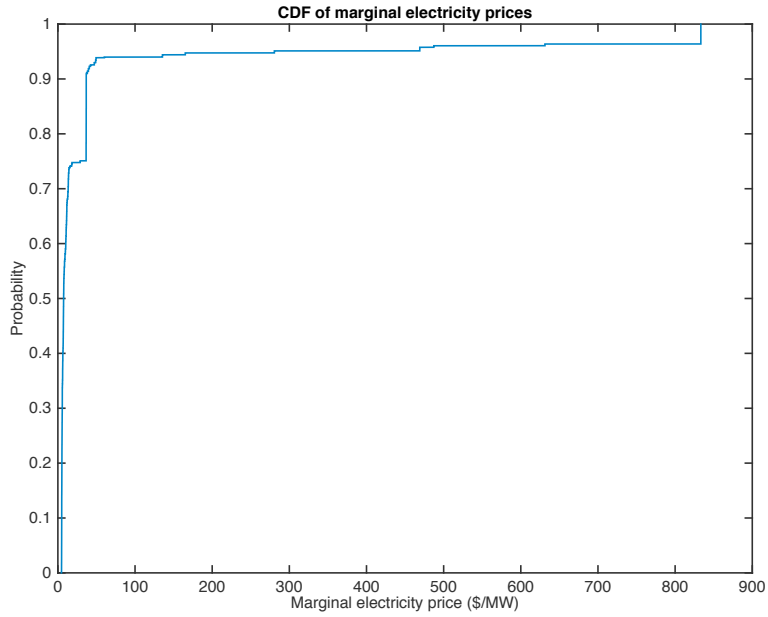

Figure 3-29: CDF of marginal electricity prices

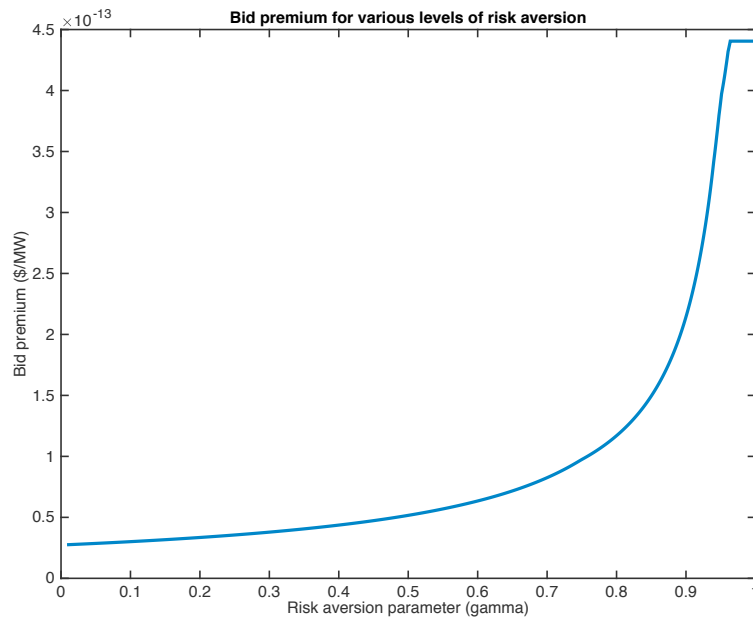

Figure 3-30: Risk premium and risk aversion in forward capacity bid

### Forward capacity market financial penalty risks

Lastly, as part of ISO-NE's new pay-for-performance market design, firms that do not deliver their forward capacity obligation during scarcity conditions will have their payments reduced at a penalty rate that starts at \$2,000/MWh in 2018 and eventually

rises to \$5,455/MWh in 2024. [LaFleur et al., 2014a] Firms that outperform their forward capacity obligations during scarcity conditions will receive performance incentives in the same amount. To estimate the revenue loss that a firm might incur due to these penalties and forced outages, we can use the expected unmet forward capacity obligation calculation obtained from the probabilistic production cost estimate and then multiply by the number of hours of shortage events. Arbitrarily assuming that shortage events occur during 5% of the year (438 hours), the firm’s expected performance penalty is

$$438 \text{ hours} \times 4.2 \times 10^{-17} \text{ MW} \times \frac{\$5,455}{\text{MWh}} = \$1.00 \times 10^{-10} \quad (3.4)$$

and the firm could include this cost in the risk component of its forward capacity market bid.

Currently, FERC, ISO-New England, and market participants are actively discussing ISO-New England’s redesign of its forward capacity market. These forward capacity explorations illustrate how the modeling tool developed in this dissertation can be used in a regulatory setting to understand, quantitatively on the order-of-magnitude level, the risk that firms can face and how firms might respond to new market designs.

### **Gas shortage and risk modeling**

Generation firms face risks from forced outages as well as not being able to secure enough pipeline capacity to meet their daily fuel requirements. We use a technique presented in [Dueñas et al., 2011] that adapts traditional conditional value at risk (CVAR) constraints to explore how firm transportation decisions might change if a central planner is risk averse to not having enough transportation to meet its gas consumption. In that formulation and the formulation previously presented in Chapter 2, the central planner requires each firm  $g$  to meet with arbitrary probability  $\beta_g$  an arbitrary fraction,  $A_{\min,g}$  of its gas transportation using firm contracts. Here, we apply this technique to the case study to learn broad trends about the gas-electricity

system. However, it is important to note that for practical business decisions, the number of scenarios considered likely needs to be at least an order of magnitude larger to more thoroughly represent the range of possible future scenarios.

To establish a risk-neutral benchmark, we first run the system state optimization with no conditional value at risk constraints. Then, the daily fuel consumption decisions for each firm and scenario serve as estimates of the firm’s daily fuel consumption in the CVAR optimizations. Figure 3-31 shows how firm 2’s long-term pipeline transportation decisions change with different values for its risk averseness parameters.

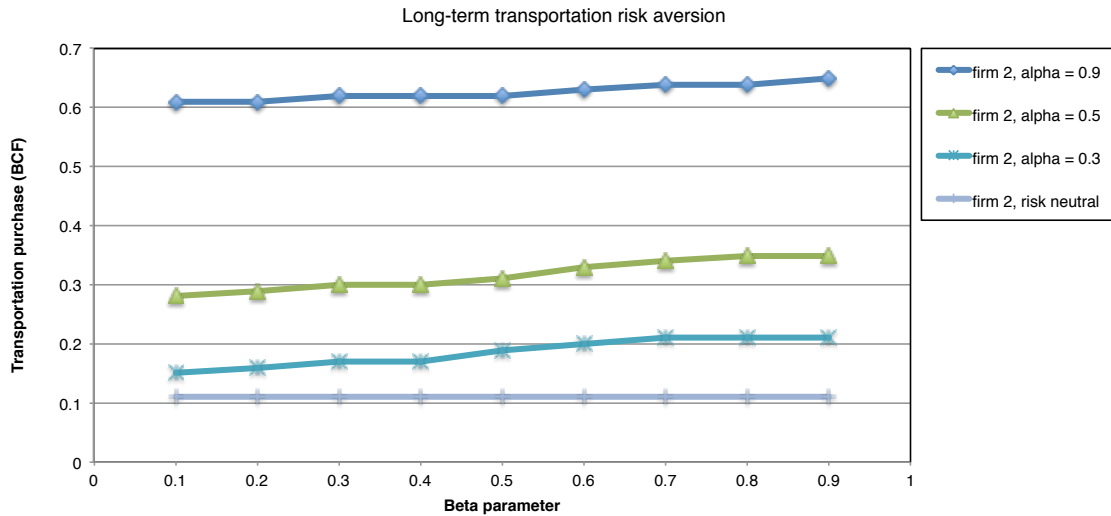

Figure 3-31: Long-term pipeline transportation purchases with risk aversion

As a firm’s risk averseness to not having enough transportation to meet its daily gas consumption increases, so does its long-term pipeline transportation purchase. Figure 3-31 shows the firm’s purchases at different values for each risk aversion parameter. For this example, if firm 2 wants to meet 90% of its pipeline capacity requirements with firm transportation for 90% of all days, then it needs to purchase six times more capacity than it otherwise would if it were risk neutral. The firm’s transportation requirements on any given day over the course of three years has a large dynamic range and is upper bounded at approximately 0.55 BCF, or one-fifth of the size of the entire pipeline coming into this power system. This range suggests

that any substantial purchase of capacity in an attempt to guarantee adequate gas transportation will likely result in excess capacity on other days that the firm then may or may not be able to use in some other capacity, depending on the electricity and gas markets that day and the nature of the firm’s long-term purchase. Regulators and policymakers that have wondered why power generation firms in New England tend to not purchase firm transportation thus far may find this particular set of relationships between daily gas consumption, short-term interruptible transportation, long-term firm transportation, and risk aversion useful in designing economic incentives to encourage fuel assurance.

### 3.4 Conclusions

The experiments and hypothetical explorations conducted for this case study serve as common-sense checks for the proposed gas-electricity model in Chapter 2 and as a vehicle to gain greater understanding of the interactions between the gas and electricity decisions of generation firms and the risks that they face. This case study abstracted key historical data and aspects of New England’s gas-and-electricity system and generated several lessons, including:

1. Given current demand levels and New England’s capacity mix, New England can substitute some generation technologies in place of natural gas when transportation prices are high. New England depends heavily on natural gas, but it can dispatch other power plants—typically oil-fired power plants—during substantial shortage events. This may lead to a dual-fuel dependency problem if New England is unable to acquire enough natural gas and oil, as there are no other power plants to dispatch.
2. During high demand electricity hours, New England’s gas-centric capacity mix leaves the power system dependent on natural gas and highly inelastic to the price of gas transportation. In the immediate term, this poses a reliability problem during pipeline scarcity events, and either ISO-New England or poli-

cymakers may need to intervene in the short term to prevent pipeline scarcities from affecting power system reliability. In the intermediate and long term, this may present an investment opportunity for new entrants.

3. Pipeline availability and long-term pipeline transportation prices play the largest role in determining a firm's forward capacity bid relative to other factors such as plant maintenance and unforced plant outages.
4. New England's consumption of natural gas for electricity can vary drastically from day to day. This wide range poses a large risk for generation firms with respect to securing long-term pipeline transportation because on many days, firms can secure interruptible pipeline capacity from the short-term spot market. The wide range of available pipeline capacity from day to day may partially explain why generation firms in New England, thus far, have hesitated to commit to long-term pipeline transportation despite high short-term congestion prices and pipeline capacity shortages.

In addition to these broad findings, this case study introduced a method to evaluate how forced outage rates may impact a firm's ability to meet its forward capacity obligations based on a probabilistic production cost algorithm. Continuing this chapter's exploration of forward capacity markets, in the next chapter, we will discuss the regulatory, policy, and social challenges of using forward capacity markets to procure capacity for electricity and draw a few generalizable infrastructure ideas that may also apply to other basic goods.

THIS PAGE INTENTIONALLY LEFT BLANK



# Chapter 4

## General lessons

Gas and electricity systems provide a rich set of interactions for policy makers and regulators to study, particularly with respect to the successes and problems associated with wholesale electricity markets. A decade ago, power systems in New England and other parts of the United States featured relatively small amounts of gas-fired generation in an environment with ample short-term, interruptible (unguaranteed) pipeline capacity from local distribution companies and industrial users, as well as relatively high natural gas prices. As market and environmental forces played out over the last decade, natural gas prices fell and investment in gas-fired power plant capacity increased substantially. In 2013, gas-fired power plants accounted for 41% of ISO-New England’s capacity mix, and gas failures—mostly the inability to transport gas due to limited pipeline capacity—emerged as a new and substantial reliability problem for the electric power system. [ISO-New England, 2013b][ISO-New England, 2013a]

As described in [Pérez-Arriaga, 2013], reliability problems encompass a large set of concerns that span multiple temporal dimensions. Representative examples of these temporal dimensions include security of supply (matching demand and supply in the immediate future), firmness of supply (matching demand and supply looking out a few hours to the next one or two years), and adequacy of supply (ensuring that enough capacity exists to meet future demand a few years out). New England’s gas-and-electricity issues demonstrate the important link between a system’s adequacy and its firmness—even when enough capacity exists to meet demand, firmness prob-

lems related to forced outages, pipeline scarcities, maintenance schedules, and other unforeseen circumstances can still create reliability challenges.

In power systems with wholesale electricity markets, regulators and system operators have known that investment in power plant capacity to meet future demand may be inadequate given the uncertainty and risk that individual firms face. [Pérez-Arriaga, 2013][Vázquez et al., 2002][Rodilla, 2010] The adequacy problem arises due to a key difference between theory and practice: although mathematical models may suggest that a few hours of extremely high electricity prices will allow a firm to make a positive profit over time if that firm makes a particular investment decision, firms themselves may be too risk averse to depend on the realization of a handful of high-priced electricity hours each year to earn a profit. Rather than invest, these firms may instead opt to do nothing. Power systems with wholesale markets have implemented a variety of solutions to try to address the problem of adequacy ranging from modifying electricity prices during times of scarcity to implementing forward capacity markets, which create a new electricity commodity—future power plant capacity—for firms to offer. [Vázquez et al., 2002]

Forward capacity markets, ideally, should improve future short-term reliability by providing revenue certainty to firms in exchange for their guarantee of available capacity. Typically, both new and existing market agents participate, allowing new entrants and technologies to potentially set the marginal price. In New England, the system operator determines how much forward capacity it needs by geographic region, and then generation firms offer into this market until the market clears under a reverse-auction mechanism. [Ausubel and Ashcroft, 2007] In other power systems, such as New York and California, the system operator requires load serving entities to purchase a qualified “capacity product” from generation firms in proportion to their projected future demand. Generation firms, in exchange, are only qualified to sell a fixed amount of capacity based on the past performance of their power plants, or an estimate of future performance for new entrants. Firms implicitly have an incentive to keep their power plants operational so that they remain eligible to bid into the capacity market in future years.

However, in New England, the forward capacity market design to date has not strongly connected the issue of system adequacy with system firmness, and the New England power system now experiences more reliability challenges than it did in the past due to its dependence on natural gas and scarcities of pipeline capacity despite having an ample supply of gas-fired power plant capacity. In this chapter, we primarily focus on lessons learned from the application of forward capacity markets to electricity because (1) forward capacity markets represent a technology-neutral approach to solve the adequacy problem; (2) participants in current gas-electricity firmness discussions for New England have heavily focused on the failures of the current forward capacity market; and (3) the lessons learned from forward capacity markets for electricity may have broader applications to other basic goods.

To complement the work in previous chapters that modeled coupled gas-electricity systems, we identify the properties of electricity that can be difficult to fully value and capture with market approaches and the impact that these difficulties may pose for the design and implementation of wholesale electricity markets in general, and forward capacity markets specifically. We focus on electricity's importance as an energy source for basic services and its real-time physical operating difficulties to explore the following questions: what might New England's reliability concerns teach about using forward capacity markets to ensure system adequacy and firmness for other basic goods? What defining traits does electricity share with other basic goods that might make these lessons transferable?

## 4.1 A description of electricity

In this section, we review the overarching qualities of electricity to understand why scarcities of electricity differ from scarcities of other energy commodities. Then, in the remainder of the chapter, we refer back to this description to try to understand and explain why certain features of electricity markets and regulations are structured as they are, and then try to identify other basic goods with similar attributes to electricity that may benefit from some of the market and regulatory tools in power

systems.

### 4.1.1 Defining features

Electricity exhibits several social and physical features that make it a useful, difficult to substitute, and difficult to physically manage energy commodity. First and foremost, most citizens in first-world countries perceive electricity as a necessity good, and few would argue against the idea that everyone should be entitled to at least a basic amount of electricity that enables lighting, heating, cooling, and cooking for shelter and food. Second, electricity has many potential “fuel” inputs (e.g., coal, natural gas, and wind), but none of these input fuels are viable substitutes for all of the ways that consumers use electricity. Of the basic ways that most consumers use electricity, cooking and heating are likely the least labor intensive to substitute another fuel for. However, given that many of these substitutions also involve durable goods with high fixed costs (e.g., gas/electric cooking ranges), consumers are unlikely to switch frequently, if at all. Consequently, the large number of basic needs that electricity fulfills for consumers and the lack of easy alternatives makes scarcities of electricity socially and politically unpalatable.

To supply electricity reliably for basic needs and other uses, power systems must constantly balance supply and demand as a matter of physical law. Two factors complicate this physical requirement. First, due to network and physical power plant operation constraints, not all market solutions that balance supply and demand are feasible. Depending on how much demand changes from hour to hour and where these changes occur geographically, a power system may not be able to dispatch all of its available power plants to meet these changes. Second, the lack of economical storage options for electricity in most power systems (with the exception of geographically-specific pumped hydro and hydro reservoir technologies) greatly limits opportunities to store excess generation from one hour for use in a future hour. The inability to store electricity also limits the power system’s flexibility to dispatch power plants that cannot quickly change their output levels. The combination of the electric power system’s physical need to remain in constant supply and demand balance, combined

with the lack of economic storage for managing short-term excesses and shortages, substantially increases the real-time difficulties of operating a power system.

Electricity acts as an important energy carrier to enable basic services for shelter and food, but reliable transmission and consumption of electricity requires that a power system balance supply and demand in real time. To this description of electricity’s characteristics we add the fact that social expectations in the form of regulations and policies can further complicate what the technical and physical power system must accomplish. For example, environmental concerns have led to laws that will force some power systems to increasingly remove coal capacity and incorporate renewables. In other power systems, safety concerns and social pressures have shut down nuclear power plants. These types of social expectations limit the range of technologies that power systems can deploy. In aggregate, the decisions makers responsible for supplying electricity need to do more than just provide reliable electricity—they must provide reliable electricity that is also affordable, environmentally friendly, and safe.

Electricity enables basic services for consumers such as cooking, heating, cooling, and lighting. As a commodity, electricity can be made with different energy inputs such as oil, coal, gas, and wind, but few viable alternatives exist for electricity itself. Given electricity’s importance as a basic good, the lack of viable alternative fuels for its end uses, the physical difficulties inherent to operating a reliable power system, and the demands that society places on its power systems, how should decision makers for power systems respond to scarcities of supply?

#### **4.1.2 Commodity versus basic good**

One of the interesting aspects regarding how a power system should respond to supply scarcities stems from the fact economic theory already contains a well-established framework for how supply and demand should reach an equilibrium. Broadly, economic theory states that high prices and supply failures should teach consumers to either withdraw demand or learn to “express their risk aversion to shortages” [Rodilla, 2010] via instruments such as hedging contracts. Under this framework,

price volatility and iterative supply/demand failures are not necessarily undesirable in and of themselves because they provide consumers and suppliers with information and investment signals. Microeconomic theory also states that welfare is maximized when scarce resources are allocated to those who have the highest utility for those resources. Because the most common method to measure utility is in monetary units, in a straightforward market response to supply scarcity, prices should increase and the available limited supply of electricity should be allocated to consumers who demonstrate the highest willingness to pay. [Varian, 2010]

However, electricity's status as a basic good complicates such a straightforward economic allocation of scarce supply. Scarcities of basic goods can drastically impact a society and tend to produce social and political problems.<sup>1</sup> Allocating scarce electricity supply to those who express the highest willingness to pay contains ethical implications for the poor, who may not be able to fully express their utility for electricity in monetary units. The first few kilowatt-hours of electricity that enable basic services have high utility to all users, but poor consumers are the least able to pay for those first few necessary units.

Power systems with wholesale electricity markets have already developed several solutions to handle scarce electricity supplies that do not require consumers to experience iterative shortages and volatile prices. These solutions include voluntary demand response programs for consumers that are able to withdraw consumption, as well as tiered, average tariffs that shield small consumers from real-time prices and allow them to affordably consume a minimum level of electricity for basic uses. Generally, larger companies such as electricity retailers and demand response aggregators represent groups of small consumers and participate in wholesale electricity markets on their behalf. While these larger companies are exposed to real-time pricing volatility, the small consumers that they represent typically are not (although this is also beginning to change with smart meters that can tell consumers how much their elec-

---

<sup>1</sup>In 2001, California experienced substantial electricity shortage issues in the summer due to a series of unrelated events that led to rotating, scheduled blackouts throughout the state for months. The shortages featured prominently in a recall election that then-presiding governor Gray Davis eventually lost.

tricity costs in real time). Most power systems with wholesale electricity markets also impose price caps to suppress extremely high prices and deploy out-of-market instruments to ensure reliable supplies during times of shortages. However, these market modifications can dampen real-time prices that simultaneously serve as signals for large consumers to quit consumption in the short term and for generation firms to invest in additional capacity in the long term, resulting in more pricing distortions that require further attention.

Broadly, these commodity-based concerns highlight how strict market implementations for electricity commodities—not just energy, but also forward capacity—may ignore important characteristics of the underlying commodity. Consequently, using markets to address a power system’s adequacy and firmness concerns requires implementations that acknowledge 1) the social value of electricity as a basic good; 2) the inability of demand to fully withdraw; and 3) that high prices and supply shortages serve as important, technology-neutral signals to guide individual short- and long-term behaviors.

## 4.2 Lessons from New England

The basic services that electricity enables and the potential inability for demand to significantly withdraw during times of shortage support the importance of ensuring system adequacy and firmness by encouraging investment. In particular, in situations when demand is unable to respond for any reason, the “basic good” aspect of electricity and the physical need for supply and demand balance throughout the network depend on power plant capacity to perform during shortages. While firmness problems can occur in real time for any number of reasons, New England has experienced a substantial disconnect between the outcome of its forward capacity market—which should have guaranteed the power system sufficient available power plant capacity to meet demand throughout the year—with the actual real-time performance of its gas-fired power plants during cold weather events.

Despite substantial installed gas-fired power plant capacity in New England, a

lack of fuel assurance on the part of individual generation firms has led to large declines in the amount of actual gas-fired capacity that was able to perform during cold weather events in past years. In 2014, generation firms in ISO-New England committed to forward capacity obligations totaling 29,835 MW out of a total possible 32,445 MW; i.e., in aggregate, generation firms in New England promised that 92% of their total capacity would be available throughout the year. However, gas-fired power plants accounted for approximately 11,000 MW of all of New England’s power plant capacity, which implies that gas-fired power plants must have held forward capacity obligations between 28% to 37% of the total 29,835 MW that cleared the forward capacity market, or approximately 10,000 MW. As noted by ISO-New England in [ISO-New England, 2015], winter storm events such as “Nemo” in January 2013 have shown that during cold weather events, “pipelines are capable of supporting less than half this amount.” [ISO-New England, 2015] Empirically, New England’s forward capacity market thus far has not led participants to take the preemptive actions necessary to ensure that they can meet their obligations.

Regulators, system operators, market participants, and other vested interests from the energy sector have debated the relationship between fuel assurance and forward capacity markets in regulatory proceedings aimed at resolving the disconnect between system adequacy and firmness. Some generation companies have argued that the forward capacity market’s intent is solely to ensure a minimum level of power plant capacity in the power system, while regulators and system operators have reiterated the importance that any firms with forward capacity obligations must actually perform during supply shortages. [LaFleur et al., 2014b][LaFleur et al., 2014a] Learning from the implementation and results of its original forward capacity market design, in 2014 ISO-New England proposed, and the Federal Energy Regulatory Commission (FERC) accepted, a new forward capacity market design that more closely links real-time performance with a firm’s forward capacity obligation. To address the three-year gap between when its new forward capacity auction takes place (2015) and when the first set of obligations from this auction begins (2018), ISO-New England also implemented a winter reliability program based on indicative planning to secure



demand response and dual-fuel capable capacity. With these changes, ISO-New England should be able to fix the disconnect between system adequacy and firmness in its forward capacity market, as well as mitigate the immediate reliability concerns over the next three years before the first obligations for the new forward capacity market design take effect. In this section, we describe the key challenges of New England’s past forward capacity market and the key features of its new market design and indicative planning measures.

#### 4.2.1 New England’s original forward capacity market

In the original design of New England’s forward capacity market, the system operator set a fixed forward capacity target based on its projection of future electricity demand, and generation firms could offer “qualified” capacity from each of their power plants toward this capacity target. Each firm’s capacity offer is how much capacity that firm essentially promises to be available three years in the future. From each power plant, firms can offer up to the median of that power plant’s seasonal claimed availability over the last five years. [ISO-New England, 2014b]

ISO-New England’s original forward capacity market carried shortage/unavailability penalties for firms that received payment for a forward capacity obligation, but then were unable to meet that obligation in real time. The penalty allows ISO-NE to claw back forward capacity payments as defined in III.13.7.27.1.2 of Market Rule 1 and operates as follows: [ISO-New England, 2014b]

$$p = (a)(f)(1 - s) \tag{4.1}$$

where  $p$  is the total penalty owed by a firm;  $a$  is a firm’s total annual forward capacity payment;  $f$  is a penalty factor that starts at 0.05 and increases by 0.01 for each hour that a shortage event extends beyond 5 hours; and  $s$  is a shortage event availability score that expresses the fraction of time that a plant is unavailable during a shortage event. Importantly, on any given day, penalties cannot exceed 10% of a firm’s annual forward capacity payment; for any given month, penalties for the firm were capped

at 2.5 times the firm's annual forward capacity payment divided by 12; and for any given commitment period, the entire penalty could not exceed the firm's total capacity payment. If a power plant received three consecutive annual availability scores of 40% or less, then that power plant could no longer participate in future forward capacity markets until it demonstrated three consecutive annual availability scores of 60%.

When shortage events occurred during cold weather events, gas-fired power plants frequently could not contribute their total capacity because they could not acquire enough pipeline capacity. During these shortage events, generation firms had to pay the penalty specified above for missing their forward capacity obligation, but they did not have to pay in real time for energy in an equal amount to their deviation from their forward capacity obligation. Because firms also could not lose any more than the revenue that they earned from the forward capacity market, firms took on no risk to participate in New England's original forward capacity market. This market did not lead to more real-time capacity to manage electricity shortages because the underperformance penalties only weakly connected forward capacity revenues with real-time performance. [FERC, 2014]

#### **4.2.2 New England's new forward capacity market**

ISO-New England's new forward capacity market design, which FERC approved in June 2014, contains two distinct changes to address the disconnect between system adequacy and firmness. First, to address performance problems, firms acquire a physical obligation with their forward capacity award and must now settle deviations at real-time prices during shortage events. In addition to acquiring a physical obligation to supply or purchase energy in real time, firms will also receive a performance-based penalty or incentive payment relative to their forward capacity obligation. [LaFleur et al., 2014a] Firms that supply energy during shortage events in excess of their forward capacity obligations will receive revenue from firms that underperform relative to their forward capacity obligations. The underperformance penalties start at \$2,000/MWh and increase to \$5,455/MWh over six years, to allow market participants an opportunity to adjust to the new forward capacity market.

[LaFleur et al., 2014a] These changes to the forward capacity product allow all generators in the system, regardless of whether they initially were awarded a forward capacity obligation or not, to receive additional income in recognition of their energy contributions during shortage events. Additionally, the financial penalties now allow generators to lose more money than they might earn from the forward capacity market if they offer capacity from a poorly performing unit.

Second, to limit the risk that firms face if they are unable to meet their forward capacity obligation, the maximum amount of money that each firm can lose is three times the starting price of the reverse auction multiplied by the firm's cleared capacity obligation. Under this new penalty structure, firms can lose more than the amount of money that they originally earned when acquiring their forward capacity obligation. Firms also have a variety of techniques to mitigate their risk throughout the year, including trading under- and over-performance with other firms. ISO-New England's market changes attempt to address both the performance shortcomings of its previous forward capacity market and the potential participation shortcomings that its new forward capacity market may experience due to risk aversion on the part of individual firms.

Interestingly, both of ISO-New England's forward capacity market designs match suppliers against a target capacity threshold, with small consumers participating via demand response aggregators only as another potential supplier.<sup>2</sup> The system operator makes a forward projection of how much capacity the system will need three years into the future on behalf of consumers, and then suppliers make offers that include their own estimation of risks and the associated costs of those risks if they are awarded a forward capacity obligation. The decision to administratively set the desired level of forward capacity reflects a difference in the sophistication of electricity consumers with respect to their ability to evaluate and hedge risks

---

<sup>2</sup>Given the technology-neutral nature of the forward capacity market, as distribution networks evolve and small consumers increasingly utilize technologies such as roof-top solar installations, electric vehicles, and micro combined-heat-and-power units to supply their own energy needs and sell energy back to the power system, these consumers could potentially participate in forward capacity markets via aggregator companies much in the same manner that small consumers currently contribute to demand response via large aggregators.

compared to electricity suppliers, and FERC itself has acknowledged as much in its regulatory statements:

“We generally agree with ISO-NE that under this market design suppliers, not consumers, are in the best position to assess and price the performance risk associated with their resources. This includes risks beyond a resource’s control, including weather-related outages. Because suppliers are expected to price this risk into their offers, it is fair to assume that those resources with better performance characteristics will include a lower risk premium than other resources and be more likely to clear, thereby improving overall fleet performance.” [LaFleur et al., 2014a]

### **4.2.3 Winter reliability program**

The first set of obligations for ISO-New England’s new forward capacity market design will take place in 2018. However, given the immediate reliability problems for the winter of 2013/2014 and 2014/2015, ISO-New England also implemented a winter reliability program to ensure that the power system had enough power plant capacity and fuel to operate reliably throughout the winter. The three substantial components of this reliability program consist of securing additional demand response from electricity consumers to withdraw consumption during shortages, guaranteeing oil inventory, and dual-fuel testing for power plants that can burn both oil and natural gas. [ISO-New England, 2015]

In its regulatory filing to FERC, ISO-New England expressed concern that New England’s gas dependence and subsequent gas failures could cascade into a dependence on oil-fired generators and dual-fuel units capable of burning both types of fuels. Given the limited generation technologies available in New England and the relatively simpler supply chain for oil versus natural gas and other fuels, the ISO decided to specify oil reserves as one of the components of its winter reliability program:

In contrast to the issues presented by a gas or fuel-neutral solution, an oil solution provides a strategic fuel reserve with far fewer complications for

this short-term winter solution. Oil has a simple supply chain that results in the transfer of measurable amounts of fuel to a tank that is within the generators control. There is no need for the ISO to distribute or otherwise trigger the transfer of fuel. [ISO-New England, 2013c]

In total, ISO-New England determined based on historical data from its coldest winter over the last decade that it would need to secure guarantees for approximately 2.4 million MWh of energy from dual-fuel generators and demand response. For both programs, participants that were awarded obligations would be paid what they had bid for their capacity. Additionally, participants would also earn compensation for their energy based on real-time prices (with a price floor for demand response participants). The ISO explains that paying participants as bid, instead of a uniform clearing price, appropriately reflects the fact that the selection process for winners discriminates between bids based on many factors, not just price:

In designing the Winter Reliability Program, stakeholders and the ISO discussed the appropriate payment mechanism, and whether there should be a uniform clearing price or bidders should be paid their “as bid” price for the demand response and oil inventory services. The ISO concluded that the “as bid” price would be more appropriate for this particular winter solution, as the assessment of the winning bids will not consider price alone (a uniform clearing price would be the design choice if price were the only consideration in the selection of winning bids)...Under these conditions, where winners are being selected based on non-uniform characteristics, applying a uniform price is inappropriate because all of the selected resources are not the same.

Lastly, in choosing the components of its winter reliability program as an out-of-market, indicative planning measure, the ISO notes that practical time limits strongly constrained the measures that it proposed to solve the region’s immediate reliability problems:

The ISO stated that its objectives for winter 2013-14 were to develop a solution that (i) obtained the incremental energy needed if colder than normal weather occurs; (ii) in time for the winter; (iii) with minimal market distortions.

These objectives, and, in particular, the “in time for winter” requirement, limited the universe of possible solutions. After accounting for the time for the stakeholder process and Commission approval, the ISO estimated that stakeholders and the ISO would have about two to three months to implement the chosen solution. This time frame effectively precluded solutions that required significant software or market changes.

[ISO-New England, 2013c]

In summary, New England’s old forward capacity market improved system adequacy, but did not improve firmness because of weak penalties between a power plant’s forward capacity obligation and its real-time performance. To address the disconnect between its power system’s adequacy and firmness, in New England’s new forward capacity market, participants now acquire both a physical obligation to deliver energy (either by generating energy itself or by purchasing energy in real time) during shortage events and a separate financial obligation to pay penalties for deviations. Additionally, all generation firms can receive compensation in real-time during shortage events if they exceed their forward capacity obligation. These market reforms should address New England’s longer term gas-electricity dependencies. However, for the next few winters before obligations from the new forward capacity market take place, ISO-New England (with FERC’s approval) has put into place several additional indicative planning measures to secure oil inventory, demand response, and dual-fuel switching capability for use during shortage events.

### **4.3 The role of indicative and mandatory planning**

Establishing a forward capacity market, determining the amount of required firm capacity, and implementing a winter reliability program to mitigate reliability prob-

lems represent clear exercises in indicative and mandatory planning in which system operators and regulators directly *indicate* or *mandate* targets and criteria for suppliers to meet. Yet, for commodities with well-established markets such as electricity and natural gas, indicative and mandatory planning measures may appear to exist in direct contradiction to relying on competitive markets to efficiently organize the behavior of consumers and suppliers. In this context, what are the ideal attributes of a forward capacity market, and when is it appropriate for policymakers to intervene in wholesale markets on behalf of consumers using indicative and mandatory planning instruments?

Given electricity's defining characteristics and New England's gas-electricity reliability problems and forward capacity market experiences, a well-designed forward capacity market should exhibit the following characteristics. First, the definition of the commodity that participants will transact should be technology neutral and allow market participants to "find" the most economically efficient technology through competition. Second, the commodity definition and settlement design should implicitly link a system's adequacy with its firmness by sufficiently penalizing nonperformance for any reason, rather than enumerating a specific set of future nonperformance events and penalties. Market designs that specify explicit nonperformance events and exemptions run the risk of not placing sufficient responsibility on market participants to internalize the cost of future uncertainties. Third, to encourage market participants to act preemptively and take the actions necessary to guarantee their forward capacity obligations, market participants must face the risk of negative revenues (i.e., penalties) in excess of what they can earn from the forward capacity market for underperformance. Fourth, the obligation that a forward capacity market imposes on individual firms should be short enough to not implicitly represent a mandate, but long enough to present a stable source of revenue to allow firms to make longer time horizon decisions in light of uncertainty and risk about the future. And fifth, as consumers tend to be less sophisticated than suppliers about evaluating and hedging risks in electricity markets, and consumers ultimately pay all of the costs for the forward capacity market, a forward capacity market should allow participants to declare their

full costs due to any risks that they believe that they may face, but must also allow regulators and market operators to monitor bids for market power.

In an ideal forward capacity market, fuel assurance represents only one of many risks that generation firms face. Viewing fuel assurance in this manner, as opposed to viewing fuel scarcity as a substantial and known risk that markets should specifically resolve, highlights a difficult policy and regulatory problem for consideration: what role should indicative or mandatory planning play for known and substantial problems that markets have not internalized?

Historically, natural gas is not the only fuel that New England has experienced problems with. In [LaFleur et al., 2014b], FERC notes that while “comments from the Capacity Markets Technical Conference and Polar Vortex Technical Conference brought recent attention to the issue of fuel assurance in RTOs/ISOs, the Commission has highlighted such concerns in the past. For example, as early as 2006, the Commission met with utility and railroad representatives to discuss railroad coal-delivery matters and their impact on markets and electric reliability.” [LaFleur et al., 2014b] Currently, however, in 2015, coal reliability is not a concern for New England given its gas-centric capacity mix. The non-uniqueness of fuel assurance concerns for natural gas serves as a reminder that if system operators and regulators are able to successfully define a technology-neutral forward capacity commodity with strong performance penalties that solve current fuel assurance concerns, then this same market design may be able to address future fuel assurance problems that arise for other technologies.

More generally, to what extent (if any) should the system operator try to explicitly guarantee that firms will be able to meet their obligations when clearing bids? For example, should the system operator explicitly require firms to demonstrate fuel availability, which may implicitly bias the market toward technologies with fewer fuel uncertainties? Or should the system operator implicitly try to ensure performance by setting large nonperformance penalties, which would require that the system operator correctly estimate how large the penalty must be to adequately encourage firms to act with due diligence? On the one hand, the system operator should not



award capacity obligations to firms that have no hope of acquiring fuel. On the other hand, even with perfect fuel assurance, firms may still experience other failures that prevent them from meeting their energy obligations. Requiring fuel assurance only guards against fuel supply failures, which represents one of many potential electricity reliability problems.

In light of New England’s current situation and the significance of natural gas uncertainty over the next three years relative to other reliability threats, ISO-NE and FERC’s indicative planning measures—administratively setting a forward capacity target and establishing a winter reliability program—should be viewed as complementary policy instruments to improve reliability for commodities that operate under wholesale markets. The efficiency/welfare losses that may occur will be accompanied by greater certainty that a substantial and well-known threat will not emerge. Given the previous characterization of electricity as a basic good for society in which scarcities of supply can carry tremendous negative repercussions, rather than view indicative planning tools as anathema to market-oriented approaches, perhaps an appropriate interpretation of any efficiency or welfare loss is to view these losses as the cost of certainty to hedge against a known, important problem that markets have thus far unsuccessfully internalized on their own.

## **4.4 Forward capacity markets for basic goods**

Electricity, as a basic good, exhibits characteristics and constraints that make it a difficult commodity to manage in times of scarcity. These characteristics and constraints include the fact that few, if any, viable alternatives exist for the uses that society has for electricity; that electricity supply and demand must always remain in balance; that economical storage technologies for electricity are rare and tend to be geographically specific; and that consumers tend to be less sophisticated market participants than suppliers. Consequently, shortages of supply can create social and political problems, and the lack of utility-scale storage options limits the power system’s ability to respond to real-time demand and supply fluctuations compared to

other energy commodities such as oil. Additionally, because an electric power system is essentially one large machine, supply and demand imbalances at any node can propagate quickly throughout the network. These attributes of electric power system make ensuring reliability a particularly challenging problem.

To address the adequacy and firmness component of these concerns, ISO-New England introduced forward capacity markets to give firms an incentive to invest in additional capacity and to link a firm's forward capacity revenues with its real-time performance. The basic concept of forward capacity markets in electricity—to provide companies with a longer term signal to invest and take preemptive actions to ensure available capacity—potentially can address similar adequacy and firmness concerns for other basic goods with wholesale markets.

Of electricity's many characteristics, perhaps the most relevant and general traits that help explain the existence and design of current forward capacity markets are 1) electricity's perception as a basic good and the lack of viable substitutes, 2) the relative difference in sophistication between electricity's consumers and suppliers, and 3) the difficulty of storing electricity. Due to electricity's perception as a basic good, even in spite of demand response programs, strong social and political incentives exist to ensure that supply appears rather than have demand respond. Given this fact, and given the physical reality that electric power systems need to constantly balance demand and supply because of limited storage options, reliably operating a power system requires that the power system have power plant capacity in excess of forecasted peak demand. Due to the combination of electricity's perception as a basic good and the relative difference in sophistication between consumers and suppliers, the structure of the forward capacity market specifically places the burden of risk on suppliers and the cost on consumers. While few basic goods, if any, share electricity's unique physical constraints, almost all basic goods, such as immunizations or water, share many of the social implications that arise from shortages. Additionally, almost all basic goods exhibit the same market sophistication difference between small consumers and large suppliers. For other basic goods, then, forward capacity markets may represent a useful market-oriented approach to secure future investment

in capacity and avoid shortages.<sup>3</sup>

#### 4.4.1 Forward capacity markets for pharmaceuticals

As an example, consider basic pharmaceuticals. Currently, pharmaceutical factories can manufacture a variety of drugs and immunizations. However, within a given production cycle (for example, each year), generally a factory will only manufacture a specific drug for a fixed period of time and then retools to produce a different drug. Due to the cost and downtime required to modify a factory, pharmaceutical companies typically will produce a set quantity of a drug for the entire year, and then not produce any more until the next cycle. Shortages can occur for a variety of reasons. Just like power plants, pharmaceutical factories can fail; firms may underestimate demand for the year; certain pharmaceuticals may have a limited shelf life; and quality problems may occur, reducing yields for a production cycle. The fact that pharmaceutical companies tend to produce high-margin drugs rather than low-margin drugs further exacerbates certain shortages, especially when substantial demand exists for the lower margin pharmaceuticals, such as sterile injectable fluids.<sup>4</sup> [Tavernise, 2014]

As in power systems, consumers of pharmaceuticals tend to not be in a position to withdraw demand, and they tend to be less sophisticated market participants

---

<sup>3</sup>Given this dissertation's exploration of the relationship between gas and electricity, a natural question arises regarding whether forward capacity markets could be used to directly secure additional investment in natural gas pipelines. The question is somewhat misleading because of the different business models that govern the production of electricity and natural gas versus the transmission of electricity and natural gas. While wholesale electricity markets allow generation firms to compete to sell electricity, all generation firms and consumers connect to a singular transmission system that facilitates competitive trade between suppliers and consumers. Due to economies of scale, concerns about market power if transmission operators also owned generation assets, and the economic difficulties that merchant transmission investors face with respect to owning firm transmission rights and collecting congestion revenues (see [Pérez-Arriaga, 2013] for more details), transmission remains a regulated monopoly under cost-of-service. Natural gas pipelines closely resemble electricity transmission networks, even though multiple pipeline operators can serve the same large geographic region. As previously reviewed in Chapter 1, FERC Order 636 required pipeline operators to divest all gas production assets in order to facilitate competitive trade between gas consumers and producers. In exchange, pipeline operators earn regulated rates of return based on the volume of gas that moves through their networks, and new pipeline investment requires regulatory approval. In this business context, forward capacity markets to competitively secure additional pipeline investment from pipeline operators do not make much sense because pipelines are not competitively built.

<sup>4</sup>The original idea for applying forward capacity markets to drugs came from Tal Levy, my colleague and coauthor of the gas-electricity paper in Appendix A.

than pharmaceutical companies with respect to hedging against the risk of shortages. Given the similarities between pharmaceuticals and electricity with respect to being “basic” goods and to the relative sophistication of market participants, forward capacity markets may represent a market-based solution for the pharmaceutical industry’s adequacy and firmness challenges. As in electricity, a forward capacity market could be set up by a central agent—in the United States, perhaps the Federal Drug Administration (FDA). The FDA, on behalf of consumers, could project future demand for important low-margin drugs, and then establish a forward capacity target and market for pharmaceutical companies to offer into. As in forward capacity markets for electricity, pharmaceutical companies would be allowed to bid their opportunity cost and risk premiums (subject to market monitoring by the FDA), and proportional costs for forward capacity could be allocated to consumers at the time of consumption. Such an arrangement would give pharmaceutical companies a new incentive to maintain their factories to minimize outages and improve yields, and this arrangement would help ensure adequate supplies for low-margin pharmaceuticals that meet basic needs.

#### **4.4.2 Forward capacity markets for water**

Water shares many of the public good characteristics of electricity and basic pharmaceuticals. Everyone needs access to a minimum level of clean water to survive, and access to clean water contributes to the public good in vast and difficult to quantify manners that range from improving sanitation to enabling farming for an entire society. Water also shares many of electricity’s physical characteristics. From year to year, supplies are subject to tremendous uncertainties due to difficulties such as forecasting future snow and rainfall, estimating ground absorption rates, and measuring underground water resources. Additionally, water can be difficult to store depending on geography and is not always easy to track. Massive physical structures such as dams, reservoirs, and aqueducts are needed to transport water through time and over long distances.

Countries such as Australia and Chile and states such as California have implemented water markets to varying degrees that allow owners of water rights to trade

with one another with some success in conserving limited water supplies for high economic value uses. [Hanak, 2014] Yet, as noted by [Howitt and Hansen, 2005], “because water has both private and public good characteristics, it has often been developed with some degree of public financing or subsidies. Hence, its reallocation generates heated controversy—especially when potential profits are involved.” In California, the use of water markets to allocate scarce water resources has particularly large global implications given the state’s recent drought over the last half-decade and California’s importance to global agriculture. In California’s water market, participants can trade “wet” water that they own the rights to. “Wet” water refers to water that actually is available for consumption, not water that a market participant simply owns paper rights for. As noted in [Hanak and Stryjewski, 2012], wet water can come from excess water in surface reservoirs, conserved water that a participant owns the rights to but does not use, and groundwater. In California, most available water for trade is either conserved water or groundwater from farmers. During times of drought, water trading allows farmers that grow less economically valuable crops to transfer their water to crops with higher economic value. More generally, when water is scarce, water markets can help efficiently allocate scarce supplies.

Based on lessons from electricity and given water’s numerous similarities to electricity, can water markets benefit from the use of forward capacity markets to improve system adequacy and firmness during times of drought? On the one hand, forward capacity markets could certainly be established to motivate further conservation (demand response) and investment in desalination technologies that are currently too expensive. On the other hand, unlike electricity and basic pharmaceuticals, water “production” is not easily controlled, and regions that rely on forward capacity markets may run into substantial firmness challenges similar to the fuel assurance problems discussed in this chapter. Water markets mostly facilitate trading of existing water rights between agents. As previously noted, in markets such as California, participants can only trade “wet” water rights. In other water markets such as the Colorado-Big Thompson water market, a participant’s annual water share depends on the actual total water supply in a given year, and this share rises and falls depending

on what actually happens. [Howitt and Hansen, 2005] The underlying commodity that water market participants trade is fundamentally uncertain, and a substantial and practical firmness problem would likely exist for any forward capacity market implementation. That said, this water supply risk is analogous to the risk that market participants face with forward capacity obligations in electric power systems; if water market operators are able to define a forward capacity product and implement a market that closely links capacity commitments to real-time performance, a forward capacity market for water may competitively incentivize efficient conservation and technology investment.

## 4.5 Conclusions

Concerns about system adequacy in electricity markets originally led many system operators to implement forward capacity markets to incentivize investment. However, the coupling issues between New England's gas and electricity systems has shown that in practice, the commodity definition and implementation for forward capacity markets need to not only address the adequacy dimension of reliability, but also the firmness dimension. Although forward capacity markets are relatively new, the traits that electricity exhibits suggest that forward capacity markets may serve as a reasonable market-based approach to adequacy and firmness problems with other basic goods. Specifically, for other basic goods in which demand cannot easily withdraw and a substantial difference in market sophistication exists between demand and supply, a forward capacity market that links adequacy with firmness via performance incentives and penalties may represent a neutral, market-based approach to resolve shortages while respecting the underlying commodity's more difficult to capture social value.

# Chapter 5

## Conclusions

In recent years, power systems around the world have increasingly relied on natural gas as a fuel for electricity generation due to primarily three economic and environmental reasons. First, hydraulic fracturing (fracking) has led to discoveries of abundant natural gas supplies in many countries. Second, power plants that burn natural gas emit less carbon and particulate matter than their coal-burning counterparts. Third, gas-fired power plants can operate with greater flexibility than other thermal power plants, enabling power systems to adopt larger penetrations of intermittent renewables.

For power systems that feature large fractions of natural-gas generation technologies and that experience substantial pipeline constraints, the price and availability of natural gas can strongly influence the price and reliability of the electric power system. Stakeholders from public, private, and academic groups have raised concerns about the growing interdependence between natural gas and electricity. These concerns include scarce pipeline capacities and inadequate supplies resulting in an inability to meet the electric power sector's natural gas demand, cascading fuel failures as the electric power sector increasingly substitutes oil for natural gas, and reductions in fuel diversity as firms retire nuclear and coal capacity due to market dynamics and age. Taken in aggregate, these concerns highlight the emergence of natural gas as a common potential cause of multiple failures in natural-gas-constrained power systems.

## 5.1 Contributions

To explore the coupling effects between natural gas and electric power systems, we investigated the post-investment decisions for individual firms that own gas-fired power plants because these firms uniquely operate at the intersection of gas and electricity markets, purchasing one commodity to generate and sell another. To conduct this investigation, we developed a series of mixed-integer linear programming models that explicitly represent the following decisions for individual firms over a three-year period: (1) long-term, firm pipeline transportation commitments; (2) long-term service agreements; (3) annual forward capacity offers and maintenance schedules; and (4) daily fuel purchases and generation levels. To mitigate practical computation challenges related to solving a three-year stochastic unit commitment model at the hourly scale, we described an approximation technique to separate the original formulation into a series of individual and computationally tractable subproblems. Additionally, we described a technique to evaluate a firm’s forward capacity market bid, as well as to probabilistically evaluate the impact of forced outages and quantify the firm’s risk premium due to forced outages.

This dissertation’s primary contributions include a detailed representation of a gas-fired power-plant owner’s planning problem (Chapter 2); a hierarchical application of the system states dimensionality reduction technique to solve the hourly unit commitment problem over multiple temporal scales (Chapter 2); a technique to evaluate a firm’s forward capacity market offer, including a probabilistic approach to evaluate the risk of forced outages (Chapter 3); and an exploration of the applicability of forward capacity markets to reliability problems for other basic goods (Chapter 4). The decision models developed in this dissertation can be applied to real-sized electric power systems with hundreds of power plants to analyze how individual generation firms may respond in gas and electricity markets to uncertainty about natural gas supply and electricity demand, as well as specific changes to market rules such as requiring fuel assurance for forward capacity. Lastly, the decision models developed in this dissertation can also be extended to model how firms may react to new market



rules over multiple temporal scales for power systems in which a single-node network representation suffices as a first-order approximation of the actual, underlying physical gas-electricity system.

## 5.2 Findings

This dissertation’s inspiration to study gas and electricity interactions by exploring how generation firms coordinate decisions in both markets came from New England, where the regional electric power system has experienced substantial reliability challenges due to its heavy reliance on gas-fired power plants. New England’s challenges raise several important, general questions about gas-constrained power systems. For example, how do uncertainties about gas supply and electricity demand influence a generation firm’s decisions across multiple timescales? How do these decisions in turn affect power system reliability? In gas-constrained power systems with a substantial fraction of gas-fired power plant capacity, are forward capacity markets effective policy and market instruments for securing not only investment in power plant capacity, but also other necessary goods for reliability such as transportation capacity for input fuels?

Pipeline-constrained and gas-fired-capacity-centric power systems represent one of the types of power systems that can be modeled with this dissertation’s decision tools. Applying these tools to a stylized representation of the New England power system, we learned the following trends:

1. Given that power systems that need to dispatch gas-fired power plants will likely have already dispatched their available coal and nuclear plants, the most likely candidates to replace gas-fired power plants are either dual-fuel power plants that can also burn oil and peaker plants that burn jet fuel. During severe and prolonged gas supply shortages (for example, during cold weather events), the electric power system’s inability to acquire natural gas may cause cascading fuel problems for not only natural gas, but also for oil and jet fuel. As most power systems do not have substantial storage technologies such as pumped hydro or

hydro reservoirs, a cascading fuel problem that starts with natural gas and ends with oil and jet fuel can leave a power system with very few, if any, alternative supply options.

2. Depending on a power system's size and peak demand, a generation firm's natural gas consumption can vary drastically from day to day. This wide range poses a large risk for firms with respect to securing long-term pipeline transportation because on many days, firms may be able to acquire short-term capacity rights from the spot market. In turn, this allows firms to avoid the risk of owning long-term pipeline transportation rights that they may not be able to profitably resell on days that they happen to have excess pipeline capacity. This risk may partially explain why generation firms, even in gas-constrained power systems, are hesitant to commit to long-term, firm pipeline transportation despite high short-term congestion prices and pipeline capacity shortages.
3. Certainty about pipeline availability plays a large role in determining both a firm's long-term, uninterruptible pipeline transportation purchase and its forward capacity bid. In a gas-constrained power system, certainty about pipeline availability can play a dominant role relative to other factors that can influence a power plant's availability, such as its maintenance contract decisions, maintenance schedules, and unforced outages. Firms that have certainty about their future access to pipeline capacity—regardless of whether the amount of available pipeline capacity is large or small—can make larger forward capacity commitments because they do not face the possibility of purchasing capacity that they cannot use and may not be able to profitably resell.
4. If forced to guarantee fuel availability as a condition of participating in the forward capacity market, firms that own gas-fired power plants in pipeline-constrained power systems will substantially commit less forward capacity than they otherwise would without the fuel assurance requirement if they are unable to resell their excess fuel and pipeline capacity. Given this relationship, forward capacity markets and stronger penalties may simply discourage firms

from participating in forward capacity markets, rather than encouraging further investment in pipelines.

To complement the lessons learned by modeling a pipeline-constrained and gas-fired-capacity-centric power system, this dissertation's case study of the policy and regulatory discussions in New England between the Federal Energy Regulatory Commission, the Independent System Operator of New England, and other stakeholders explored the design and failure of forward capacity markets as a mechanism to improve the region's natural gas supply and electricity reliability. Evidence from New England since the inception of its forward capacity market suggests that forward capacity products based on historical availability alone do not necessarily improve fuel assurance nor power system reliability, and a well-functioning forward capacity market must include some form of real-time performance obligation that penalizes firms if they are unable to meet their capacity obligation for any reason—including, but not limited to, the inability to acquire sufficient fuel supplies on any given day.

More generally, forward capacity markets for electricity represent an interesting mechanism to competitively secure adequate capacity and to ensure system firmness that may be applicable to other commodities. The key features of electricity that have resulted in the structure and use of forward capacity markets in some of the power systems that have adopted them include the fact that few, if any, viable alternatives exist for the uses that society has for electricity; that electricity supply and demand must always physically remain in balance, exacerbated by the fact that economical storage technologies for electricity are rare and tend to be geographically specific; that electricity is marginally priced, making investment to meet peak demand a financially risky venture; and that consumers tend to be less sophisticated market participants than suppliers and are usually unable to directly express their preferences for reliability. Consequently, although electricity trades as a market commodity, policymakers, regulators and system operators have often intervened on behalf of consumers to avoid supply and demand imbalances. Forward capacity markets and administratively set capacity targets represent one such medium-to-long-term intervention (on the timescale of multiple years) in which suppliers—including demand response from

consumers that are willing and able to quit consumption—competitively bid to provide capacity to the system, up to the administratively set target. For other basic goods that share electricity’s key physical, social, and market characteristics, forward capacity market designs that successfully link capacity obligations to real-time performance may represent a technology-neutral mechanism to secure supply.

Lastly, forward capacity markets and administratively set targets are two examples of indicative planning measures in which market participants are asked to meet a specific, administratively determined goal. If implemented correctly, these policy tools can mitigate well-known and well-understood problems. Rather than view indicative planning policy tools as anathema to entirely market-oriented approaches, perhaps an appropriate interpretation of any efficiency or welfare loss—which can be estimated using tools such as the decision models in this dissertation—is to view these losses as the cost of certainty to hedge against problems that markets have not fully internalized.

### 5.3 Limitations and future work

This dissertation represents an initial effort to model decisions specific to firms that own gas-fired power plants across multiple timescales while incorporating important hourly and daily details to study gas-electricity interactions. While the methods and models presented in this dissertation have resulted in interesting and potentially useful conclusions for decisionmakers, the speed and precision of the model formulation only allow a limited study of uncertainty scenarios. For future work, more refinements could be made to simplify the time-coupling requirements for the maintenance formulation; to endogenously incorporate the gas market (see [Dueñas et al., 2014] for one such approach); to adapt the system state formulation to incorporate more hourly constraints, such as ramping and minimum on and off times; to incorporate network representations for electricity transmission and gas pipelines; and to consider market power effects between both markets. Briefly, the ideas below describe a few of these ideas for future work:

1. Currently, the maintenance formulation endogenously makes maintenance contract and schedule decisions for each gas-fired power plant. Costs for maintenance and requirements for scheduling downtime depend on the number of starts and the number of firing hours that a power plant incurs. Because the constraints for maintenance temporally couple each power plant's generation decisions from week-to-week for one year in the medium-term problem and month-to-month for three years in the long-term problem, despite the system state representation's decoupling of individual hours in the hourly unit commitment problem, the formulation of each firm's maintenance problem presented in this dissertation still links decisions from one time interval to the next, trading a portion of the computational speed gained by using system states for the ability to model maintenance decisions. To improve the speed of each optimization run and to enable a larger exploration of uncertainty scenarios, one might try to decouple the maintenance constraints that link decisions for power plant generation levels, starts, and stops together throughout the central planner's main optimization problem.
2. The model formulation in this dissertation classifies each hour by state to achieve computational tractability when analyzing the hourly unit commitment problem for a real-sized power system over three years. However, the system state approach does not currently represent features such as ramp constraints and minimum on and off times. While these features, in reality, tend to not constrain the dispatch schedule of gas-fired power plants, a more accurate representation of the hourly unit commitment problem using system states could add support for these time-coupled constraints. For example, one could try to approximate the effect of ramping and minimum on/off times by limiting the total energy that a power plant can produce per start and stop period.
3. The model formulation in this dissertation represents firms that own gas-fired power plants as price takers in the gas market. Gas prices are exogenously set based on the daily commodity price plus the pipeline transportation price as

a function of the inelastic portion of gas demand from utilities and industrial consumers on a given day. In this market, generation firms that own firm pipeline transportation capacity have no other gas consumers to sell their excess capacity to. While this assumption reflects reality given the business models of other large gas consumers in the United States, there exists no legal reason that prevents a generation firm from reselling its capacity if it were able to find a willing buyer. A more detailed representation of the price dynamics between gas and electricity markets could endogenously incorporate considerations for reselling capacity. For more information on how to incorporate such details into the system state model, see [Dueñas et al., 2014].

4. The model formulation in this dissertation represents both the electric power system and the gas system as single node markets, with no consideration for the transmission or pipeline network. For gas-constrained power systems such as New England, this assumption is reasonable because New England receives most of its gas through the Algonquin pipeline, and Algonquin does, in fact, represent a single bottleneck for the entire northeast gas system. However, this single node model does not represent all gas-constrained power systems, and a more detailed representation of the gas and electricity network in the central planner's scheduling problem could reveal other gas-electricity relationships and dependencies.
5. This dissertation assumes perfect competition to intuit the behavior of individual firms from the central planner's scheduling problem. However, in reality, firms can exercise market power in many ways, and removing the assumption of perfect competition and simultaneously solving  $N$  profit maximization problems, one for each firm, may reveal unexpected and potentially more realistic behaviors and patterns in both markets that regulators will need to address.
6. Regarding policies for electricity and natural gas, the reliability mechanisms that this dissertation has reviewed based on forward capacity markets and indicative planning may be applicable to other goods, and electricity markets may

offer an interesting case study in market-based adequacy and firmness tools for other systems that share electricity's physical and social characteristics, such as desalination (with electricity as the input commodity and water as the output).

To the reader that has made it through this entire dissertation, this work represents the culmination of my interests in energy policy and my efforts to learn a set of diverse computational modeling skills that I could use to generate new ideas and insights for policy discussions. Having embarked on the daunting task of reading this document, I hope that you've learned much on this journey. Thank you for your time and attention.

THIS PAGE INTENTIONALLY LEFT BLANK



# Appendix A

## Gas-electricity price dynamics

Natural Gas and Electricity Markets:  
Price Dynamics for Long-Term Fuel Transportation and Pipeline Investment

Tal Levy<sup>a</sup>, Tommy Leung<sup>b,\*</sup>, Mort Webster<sup>c</sup>

<sup>a</sup>Technology and Policy Program, Massachusetts Institute of Technology, Cambridge, MA, 02139, USA

<sup>b</sup>Engineering Systems Division, Massachusetts Institute of Technology, Cambridge, MA, 02139, USA

<sup>c</sup>Pennsylvania State University, Energy and Mineral Engineering, University Park, PA, 16802, USA

\*Corresponding author; +13105618253; mail: E19-307, 77 Massachusetts Avenue, Cambridge, MA, 02139, USA

Email addresses: [tzlevy@mit.edu](mailto:tzlevy@mit.edu) (T. Levy), [tleung@mit.edu](mailto:tleung@mit.edu) (T. Leung), [mdw18@psu.edu](mailto:mdw18@psu.edu) (M. Webster)

### **Abstract**

Over the last three years, the New England region of the United States has experienced high natural gas prices and frequent pipeline capacity scarcities due to higher demand for natural gas as a primary fuel for electricity generation and heat. In this paper, we explore the incentives of key participants in the gas and electricity system—ranging from generation firms to local distribution companies, third-party arbitrage agents, and electricity consumers—to make long-term commitments for pipeline capacity. Based on the price dynamics between gas and electricity markets, we conclude that in any gas-constrained power system that operates under marginal pricing, no private group other than electricity consumers has a strong incentive to commit to long-term pipeline capacity. Yet, electricity consumers also face a collective action problem. Consequently, despite high marginal natural gas and electricity prices due to gas transportation scarcities, pipeline investment will generally fail to emerge without public intervention.

**Keywords:** gas, electricity, pipeline scarcity, congestion, transportation

## **1 Introduction**

Natural gas plays a unique role as a primary fuel in electric power systems. Gas-fired power plants emit fewer greenhouse gasses than their coal-fired counterparts, and power systems with substantial fractions of intermittent renewable energy tend to rely on gas-fired power plants for their operational flexibility. In recent years, the discovery of abundant shale formations has also lowered the commodity cost of natural gas enough to make it economically competitive with coal. For these reasons, power systems around the world have started to transition toward more gas-centric capacity mixes.

In the northeast United States, the electric power sector's growing reliance on natural gas and increasing share of overall gas consumption has raised discussions about potential reliability problems (ISO-New England 2013). In recent policy symposiums, public agencies such as the Independent System Operator of New England (ISO-NE), the New York Independent System Operator (NYISO), and the Federal Energy Regulatory Commission (FERC) and private consortiums such as the Edison Electric Institute have expressed concerns about (1) the increasing regularity of pipeline capacity scarcities, (2) the ability of the region's pipeline infrastructure to meet future gas demand, and (3) the long-term implications of gas dependence on the electric power system's fuel diversity and reliability (FERC 2012). In particular, public and private stakeholders have wondered why despite substantially elevated natural gas transportation costs and high marginal electricity prices, and despite the fact that long-term pipeline capacity purchases could reduce the uncertainty of available capacity and gas transportation costs, electricity market participants thus far notably prefer to not purchase long-term pipeline capacity.

The reliability concerns related to pipeline capacity shortages and gas-centric capacity mixes in electric power systems are relatively new, but not unique, to New England. A few authors have explored related problems. For examples, see (Leahy et al. 2012), who wrote about the substantial impacts of natural gas shortages and the resulting electricity supply disruptions on consumer surplus in Ireland; and (Woo et al. 2006), who investigated the bidirectional effects between electricity and gas systems in California and concluded that in regions where the electric power system's capacity mix is heavily gas-dependent, problems in one market can quickly precipitate problems in the other. (Woo et al. 2006)'s description of coupled gas-electricity systems aptly applies to New England, where natural gas technologies currently accounts for over 50% of all power plant installed capacity and over 40% of all generation. (ISO-New England 2013)

In this paper, we present a stylized, analytical model of a gas-electricity system and an empirical case study of actual gas and electricity prices in New England to highlight the price dynamics that can occur in gas-electricity systems with wholesale markets and to explore why market agents may have insufficient incentive to commit to long-term gas transportation. For the remainder of section 1, we review the organization of electricity and gas market in New England and the historical role of long-term transportation contracts as investment signals for the natural gas industry. In section 2, we analyze the incentives for electricity generation firms and other market participants to commit to long-term fuel transportation using an analytical model and an empirical case study of gas and electricity prices in New England during the winter of 2012. In section 3, we discuss the welfare distribution problems that can result from the interaction of gas and

electricity markets and highlight policy instruments that some states are considering or have already implemented; and in section 4, we conclude.

### **1.1 New England's Gas and Electricity Markets**

New England's wholesale gas and electricity markets operate independently of each other. For electricity, ISO-NE acts as both the system and market operator and has the responsibility of matching supply and demand and calculating marginal prices. By contrast, the wholesale natural gas market has no central clearing agent and remains dominated by bilateral transactions between "shippers" (any agent that wants to send or receive gas through a pipeline).

Because the gas market predominately relies on bilateral transactions, producers that want to sell natural gas to consumers in New England must first secure capacity rights along the entire pipeline between the point of injection and the point of delivery. In the United States, regulation from agencies such as FERC has strongly defined pipeline capacity rights, and a robust secondary market exists for trading capacity. In the winter, heavy gas demand for heating and electricity generation can lead to pipeline congestion and high prices for capacity at Algonquin, the primary natural gas market center for New England. By contrast, if a consumer takes delivery of gas at Henry Hub, a market center in Louisiana where many pipelines intersect and capacity is rarely scarce, transportation costs are usually negligible or zero; for this reason, market participants often interpret the price of gas at Henry Hub as the pure commodity price. When prices between Henry Hub and Algonquin differ, the price difference indicates the cost of transportation. Because of the marginal pricing structure of New England's electricity market, and because New

England relies heavily on gas-fired power plants, high gas transportation costs into Algonquin often translate into high marginal prices for electricity.

A large volume of economic literature exists that describe the relationships between marginal electricity prices, optimal spot prices, profits, and investments for electricity markets. For example, authors such as (Steiner 1957) and (Boiteux 1960) have explored the use of marginal-cost pricing as the optimal policy to incentivize efficient capacity investment and utilization for nonstorable commodities such as electricity. The theory on optimal spot pricing that many electricity markets operate on today, pioneered by authors such as (Mwasinghe 1981), (Caramanis 1982), (Caramanis et al. 1982), and (Schweppe 1987) and later refined by authors such as (Perez-Arriaga & Meseguer 1997), predicts that (1) the optimal spot price for every time instant is the variable cost of the marginal generation plant, and (2) that by paying each generator marginal prices, in perfectly adapted power systems, all generation technologies should earn just enough money to recover their fixed and variable costs. As a consequence of these two predictions, generation technologies with positive profits, over time, should incentivize further investment until those profits disappear. Given this prediction, and given the similarities between electricity and gas systems with respect to the lumpiness of investments and economies of scale, why have recent marginal gas and electricity prices—which are high by historical standards—thus far not incentivized more long-term commitments for more pipeline capacity?

## **1.2 United States pipeline regulation**

Long-term commitments for pipeline capacity have served as an important investment signal for pipeline owners since the 1930s, when the regulation of the natural gas industry in the United States dramatically changed from vertically integrated entities to today's competitive trading markets and regulated pipeline monopolies. The existing literature on transportation contracts and the history of natural gas regulation in the United States includes comprehensive papers by authors such as (Juris 1998), who describes the current state of gas trading in the United States; (Makholm 2006), who examines the changing environment for pipeline investments and long-term contracts from the early 1900s onward, paying special attention to the asset specificities<sup>1</sup> of the business that made pipeline investments a unique challenge for the gas industry; (Petrash 2005), who analyzes the decline of long-term capacity contracts and the growing preference for short term commitments after the start of deregulation and liberalization in the 1980s; and (Lee 2004), who provides an extensive overview of the evolution of the country's natural gas regulatory framework and highlights policy problems related to pipeline investment using California's electric power and gas system as a case study.

After the discovery of large deposits of gas in the early 1900s, utilities began building long, interstate pipelines that could transport gas from the middle of the country to local markets. After Congress passed the Natural Gas Act (NGA) in 1938 to regulate these interstate pipelines, long-term bilateral sales contracts emerged as a viable business structure. These bilateral contracts between pipeline operators and producers, and

---

<sup>1</sup> The term "asset specificities" in this situation specifically refers to the phenomenon that a pipeline's value, once constructed, depends highly on a producer's gas commodity supply at one of the pipeline and a consumer's willingness and commitment to purchase on the other end.

between pipeline operators and distributors, specified “bundled” sales of both gas commodity and transport capacity. Section 7 of the NGA facilitated the development of these long-term contracts by granting the federal regulator the authority to approve new pipeline construction projects if operators could demonstrate long-term demand for new capacity.

Currently, the most relevant regulatory acts governing pipeline investment in the United States continue to be Section 7 of the Natural Gas Act (1938) and FERC’s 1999 Policy Statement [88 FERC ¶ 61,227] regarding the certification and pricing of new pipeline projects. In the past, FERC has required the proof of demand component of new pipeline applications to include long-term contract commitments for at least 25% of the proposed capacity before the Commission would consider the application. In its 1999 policy statement, FERC removed the explicit requirement of contractual commitments, noting that the policy “no longer reflects the reality of the natural gas industry’s structure;” however, the agency continues to regard contractual commitments to new pipeline capacity as “significant evidence of demand for a project.”

Although FERC has removed the explicit requirement of using long-term contracts as the single metric for demonstrating public need for new pipelines, clearly the agency still considers long-term contracts as useful proxies for public benefit. Additionally, long-term transportation contracts, as they have always done, serve as important investment signals to pipeline operators by promising stable revenue streams. To try to understand why market participants have not committed to long-term transportation contracts despite high gas transportation costs and marginal electricity prices, in section 2, we explore the commitment incentives for key market participants.



## **2 Case study: Investment incentives for market participants**

The primary market participants in gas and electricity markets include: (1) firms that own gas-fired power plants and burn natural gas to generate electricity for sale; (2) electricity consumers, ranging from large industrial consumers to individual residential customers, who either directly purchase electricity from wholesale markets or via intermediary local distribution companies; (3) local distribution companies, who, similar to electricity utility companies (and often are the same entities), operate regional monopolies and have the responsibility to acquire and distribute gas to captive customers; and (4) private investors who seek price arbitrage opportunities. In this section, we explore the impact of rising gas transportation costs on each market participant, paying particular attention to power generation firms because of their substantial gas consumption relative to other consumers and their importance in electric power systems.

### **2.1 Generation firms with gas-fired power plants**

To highlight the price dynamics that can occur between gas and electricity markets for power generation firms, we present an analytical model of a profit-maximizing firm that owns gas-fired power plants and compare the broad analytical results to an empirical case study of gas generation firms in New England during the winter of 2012. Both analyses reveal that, somewhat contrary to intuition, in systems such as New England where gas is the marginal fuel, high fuel transportation costs and pipeline scarcities can potentially benefit both gas generation firms and other inframarginal generators.

#### **2.1.1 A stylized analytical model of a profit-maximizing generation firm**

In this stylized model of a gas-electricity system, we analyze a profit-maximizing generation firm that owns one gas-fired power plant and must decide how much long- and short-term transportation capacity to purchase, as well as how much electricity to sell, given exogenous prices. The firm’s decisions are subject to the physical constraints of its plant’s maximum capacity, transportation constraints for gas, and the firm’s total residual demand. The generation firm receives gas from a pipeline that it shares with a city whose gas demand is completely inelastic. The firm’s cost for short-term gas transportation varies directly in proportion to the city’s consumption, and the city’s demand for gas reduces the total short-term pipeline capacity available for the firm.

For this model, the firm solves a profit maximization problem over two electricity “days.” Each day contains a single period of electricity demand. Before the first electricity day, the firm must decide how much long-term pipeline capacity to commit to. The firm’s long-term gas transportation decision commits the firm to purchase an identical quantity of transportation capacity at a fixed price on each day. Then, for each electricity day, given the marginal electricity price, the firm must decide how much short-term gas transportation and gas to purchase, as well as how much energy to sell. Below, we present the firm’s profit-maximization problem. The input parameters and decision variables for the firm’s gas-electricity profit-maximization problem are as follows:

<b>parameters</b>	<b>description</b>	<b>endogenous</b>
$H_i$	heat rate for plant $i$	no
$GD_t$	city’s demand for gas on day $t$	no
$PC$	total shared pipeline capacity	
$P_{E,t}$	electricity price for day $t$	no
$P_{F,t}$	gas commodity price for day $t$	no
$P_{ST,t}$	short-term capacity price for day $t$	no
$P_{LT}$	long-term capacity price	no
$D_t$	residual demand for day $t$	no
$X_{max,i}$	maximum capacity of plant $i$	no

variables	description	endogenous
$x_{i,t}$	generation level for power plant $i$ for day $t$	yes
$s_t$	short-term capacity purchase for day $t$	yes
$y$	long-term capacity purchase	yes

The firm's daily profit function, calculated as its electricity revenues minus its fuel transportation and commodity costs, is defined as follows:

$$\pi_t(P_{E,t}, P_{F,t}, P_{ST,t}, x_t, s_t) = P_{E,t} \sum_i x_{i,t} - P_{LT}y - P_{ST,t}s_t - P_{F,t} \sum_i x_{i,t}H_i \quad (1)$$

The firm maximizes its daily profits taking into consideration residual demand, fuel cost, electricity price, and physical constraints on its fuel requirements and maximum power generation (Greek letters denote Lagrangean multipliers for each constraint):

$$\max_{\omega} \quad \pi_1 + \pi_2 \quad (2)$$

$$\text{s.t.} \quad x_{i,t} \leq X_{max,i} \forall i, t \quad : \mu_{i,t} \quad (3)$$

$$\sum_i x_{i,t} \leq D_t \forall t \quad : \rho_t \quad (4)$$

$$y + s_t \geq \sum_i x_{i,t}H_i \forall t \quad : \theta_t \quad (5)$$

$$GD_t + s_t \leq PC \forall t \quad : \gamma_t \quad (6)$$

$$x_{i,t} \geq 0, s_t \geq 0, y \geq 0 \quad : \psi_{x_{i,t}}, \psi_{s_t}, \psi_y \quad (7)$$

where  $\omega$  represents a vector of the endogenous decisions enumerated above; Eq. (3) ensures that power plants do not exceed their maximum capacity; Eq. (4) constrains the firm to generate no more electricity than the maximum demand; Eq. (5) requires the firm to have secured at minimum enough gas transportation to meet its fuel requirements; Eq. (6) allows the firm to only purchase spare capacity on the shared pipeline; and Eq. (7) enforces nonnegativity on all decisions. Reformulating the firm's profit maximization problem using Lagrangean multipliers yields the following first-order conditions at optimality:

$$\frac{\partial \mathcal{L}}{\partial x_{i,t}} = P_{E,t} - P_{F,t}H_i - \mu_{i,t} - \rho_t - \theta_t H_i + \psi_{x_{i,t}} = 0 \quad (10)$$

$$\frac{\partial \mathcal{L}}{\partial s_t} = -P_{ST,t} + \theta_t - \gamma_t + \psi_{s_t} = 0 \quad (11)$$

$$\frac{\partial \mathcal{L}}{\partial y} = -2P_{LT} + \theta_1 + \theta_2 + \psi_y = 0 \quad (12)$$

Using this description of the firm's profit-maximization problem, we can now analyze the firm's transportation decisions and profits for various market scenarios where the firm is either out-of-margin, marginal, or inframarginal relative to other firms. The firm owns one plant with heat rate  $H_i$  and must decide generation levels  $x_{i,t}$  for  $t = [1,2]$ . Starting with the intuitive out-of-margin case, when the firm is out-of-margin, the variable cost of its plant (the price of fuel multiplied by the heat rate of the firm's plant) exceeds the marginal system price:

$$P_{E,t} < P_{F,t}H_i$$

When this occurs, the nonnegativity constraint for  $x_{i,t}$  binds tightly

$$\begin{aligned} P_{E,t} - P_{F,t}H_i &< 0 \\ \mu_{i,t} + \rho_t + \theta_t H_i - \psi_{x_{i,t}} &< 0 \\ \rightarrow \psi_{x_{i,t}} > 0, \mu_{i,t} = 0, \rho_t = 0 \end{aligned}$$

and the firm generates no energy, as expected.

If, instead, the firm's plant is marginal and sets the electricity price, then  $P_{E,t} = (H_i)(P_{ST,t} + P_{F,t})$ , and the firm's profit changes in the following manner:

$$\begin{aligned} \pi &= \sum_t (P_{E,t}x_{i,t}) - (T)(P_{LT})(y) - \sum_t (P_{ST,t}s_t - P_{F,t}x_{i,t}H_i) \\ &= \sum_t (P_{ST,t})(x_{i,t})(H_i) - (T)(P_{LT})(y) - \sum_t (P_{ST,t})(s_t) \end{aligned}$$

The commodity cost term,  $P_{F,t}x_{i,t}H_i$ , disappears because the firm pays for and exactly recovers its commodity costs when its generation plant is marginal in the electricity market. The firm's short-term transportation requirements,  $s_t$ , depend on the firm's previous long-term transportation commitment and will always be less than the total amount of capacity that the firm needs on any given day by Eq. (5):  $s_t \leq (H_i)(x_{i,t})$ . As  $P_{ST,t}$  increases, the firm's revenue increases to  $(P_{ST,t})(H_i)(x_{i,t})$ , but the firm's short-term transportation costs also increase to  $(P_{ST,t})(s_t)$ . As  $(P_{ST,t})(s_t) \leq (P_{ST,t})(H_i)(x_{i,t})$ , in the worst-case scenario, if the marginal firm must entirely rely on short-term transportation, high gas prices neither help nor hurt the firm's profits.

If the firm's plant is inframarginal, assuming that a gas-fired power plant with heat rate  $H_m$  sets the marginal electricity price and requires short-term fuel transportation, then the firm observes the following electricity price trends:

$$\begin{aligned} P_{E,t} &= (P_{F,t} + P_{ST,t})(H_m) \\ H_m &\geq H_i \\ P_{E,t} &\geq (P_{F,t} + P_{ST,t})(H_i) \end{aligned}$$

Unlike in the marginal- and out-of-margin scenarios, as the cost for natural gas increases, so do the profits of the inframarginal firm:

$$\begin{aligned} \pi &= \sum_t (P_{E,t})(x_{i,t}) - (T)(P_{LT})(y) - \sum_t (P_{ST,t}s_t + (P_{F,t})(x_{i,t})(H_i)) \\ &= \sum_t ((P_{F,t}x_{i,t}(H_m - H_i) + P_{ST,t}(H_mx_{i,t} - s_t)) - (T)(P_{LT})(y)) \end{aligned}$$

Because the firm's inframarginal plant is more efficient than the marginal plant, revenues grow faster than costs:  $P_{F,t}x_{i,t}H_m > P_{F,t}x_{i,t}H_i$  and  $s_t \leq (H_i)(x_{i,t}) < (H_m)(x_{i,t})$ . Consequently, as the short-term transportation price increases, so do the firm's profits.

Given these price dynamics, ideally, a generation firm could attempt to purchase a small amount of long-term transportation capacity and capture high inframarginal rents resulting from high natural gas transportation costs. However, in a pipeline-constrained region, finding a willing counterparty to sell its long-term capacity given high short-term prices may prove difficult, given that the most likely candidates are industrial consumers and local distribution companies with relatively inelastic demand. Additionally, as the inframarginal scenario shows, high short-term transportation prices do not necessarily reduce profits in the electricity market. As long as the generation firm believes that a gas-fired generator will set the marginal electricity price, and that its own plant remains inframarginal, then high short-term transportation prices will increase the firm's profits. Given these dynamics, high marginal electricity prices and high short-term transportation prices alone do not appear to provide a significant investment signal for existing generation firms to purchase long-term transportation capacity in gas-constrained regions.

### **2.1.2 Empirical case study of power generation firms in New England**

As observed in the analytical model, higher gas prices can often benefit the profits of gas-fired power plants due to the marginal pricing structure of electricity markets. To examine whether this gas-electricity price dynamic holds for a real power system, using the Genscape NatGas Analyst dataset, we examine a period of high gas and electricity prices between November 1, 2012 and March 20, 2013, when cold weather drove substantial congestion pricing of natural gas in New England.

The Genscape dataset provides daily scheduled volumes of natural gas, by generator, to every large combined-cycle gas generator in New England. By combining these data with

each generator's heat rate (available from the United States Energy Information Administration's (EIA) e-grid data), we can estimate the amount of power that each gas generator produces on a daily basis, as well as the inframarginal rents that it earns throughout the study period. However, as data about the daily gas consumption patterns of individual power plants is not publically available, given that electricity prices can change substantially over the course of the day, we need to also estimate each plant's hourly dispatch in order to estimate its inframarginal rents.

To estimate each plant's hourly dispatch, we analyzed three scenarios of gas consumption that loosely can be interpreted as operating a gas-fired power plant to serve base, intermediate, and peak demand. For the base load scenario, we assume that a generator burns its daily gas evenly across 24 hours. Given that a gas-fired generator is more likely to burn its gas during high electricity prices than low, for the intermediate scenario, the generator burns its daily gas evenly across the 16 highest electricity price hours; and in the peak scenario, the generator burns its daily gas evenly across the 12 highest electricity price hours under the assumption that a combined-cycle plant must remain on for at least 12 hours due to thermal constraints. Figure 1 plots inframarginal rent estimates versus gas prices for these three burn scenarios. Inframarginal rents are calculated as the value of the energy produced, based on the hourly ISO-NE energy price, minus the cost of gas, based on the Algonquin daily spot price, and each plot point represents one week in the study period.

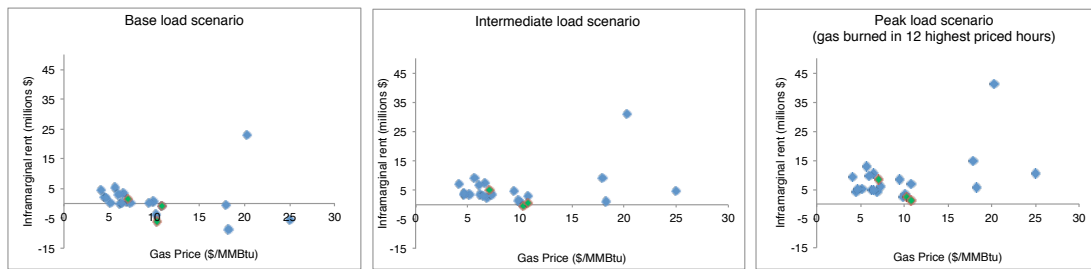

Figure 1: Weekly inframarginal rents for gas-fired generation

(holiday weeks of Thanksgiving, Christmas, and New Years shown in green)

In the base load scenario, burning gas evenly across 24 hours each day results in a negative trend between weekly average gas price and weekly inframarginal rents—if the firm operated its power plant in this manner, then high gas prices would have resulted in losses for the firm. Restricting gas-fired power plants to operating during the 16 highest priced electricity hours in the intermediate scenario and the 12 highest priced electricity hours in the peak scenario mitigates these losses, suggesting that either of these scenarios are likely more realistic than having firms operate their power plants as base load units. Knowing exactly when and how generators burned their gas throughout the day is nearly impossible with publicly available data. However, given that generation firms are unlikely to operate their plants in a profit-negative manner, the three scenarios suggest that during the study period, firms did not burn gas evenly throughout the day; rather, firms most likely operated their gas-fired power plants between the 12 and 16 highest priced hours of each electricity day.

The inframarginal rent scenarios in Figure 1 also illustrate two key points related to unusually high marginal heat rates and firm losses and profits. First, the outliers at the gas price of \$20/MMBtu show that regardless of how a firm operates its gas-fired power



plants, any week that experiences abnormally high heat rates (for example, because of supply constraints that require inefficient oil generators to start) can create large inframarginal rents. Second, regardless of how a firm operates its gas-fired power plants, the range of possible inframarginal rents that the firm can earn remains relatively small compared to changes in the price of gas. During the study period, New England experienced approximately seven weeks with average gas prices above \$7/MMBtu. Over the same time period, the difference in profits for a week with an average gas price below \$7/MMBtu and for a week with an average gas price above \$7/MMBtu was, at most, \$10 million. Based on this upper bound and the fact that New England experienced between six to seven weeks with gas prices above \$7/MMBtu, firms with gas-fired power plants could have lost at worst \$60 to \$70 million due to pipeline scarcities and high short-term transportation prices.

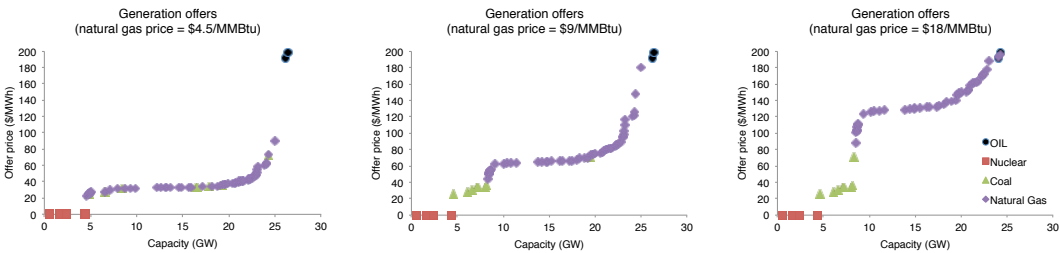

Figure 2: New England nuclear and thermal generation offers at different gas price levels

However, because the baseload scenario likely underestimates actual inframarginal rents, and because of the marginal pricing structure of ISO-NE’s electricity market, high marginal electricity prices driven by high gas prices may actually have benefitted many generation firms. To explore this possibility, Figure 2 and 3 analyze the marginal generation technology in New England and compare how marginal prices change relative

to gas prices. Figure 2 shows supply curves for various thermal generation technologies in New England under different natural gas prices. Each point on a supply curve represents a generator listed in ISO-NE's March 2013 Seasonal Claimed Capability report. The bid prices shown in the graphs were calculated by multiplying each plant's heat rate by its fuel price. Heat rates for each plant are based on data from the EIA's e-grid dataset, and the supply curves assume a coal price of \$3/MMBtu. Nuclear plants bid a price of zero in these supply scenarios, given that electricity markets tend to always fully dispatch nuclear plants barring unforeseen physical constraints. Given that aggregate peak electricity demand in the winter of 2012 ranged between 14 and 17 GWs, the intersection of this range of demand with the supply curves in Figure 2 suggest that ISO-NE frequently dispatched gas-fired generators to meet the marginal unit of electricity demand during the study period. Figure 3 confirms that gas-fired generators often set the marginal price in ISO-NE: plotting gas prices versus electricity prices results in a clear relationship between the two with an  $R^2$  of 0.93. Because gas-fired generators frequently set the marginal electricity price that all generators receive, and because gas-fired generators only account for approximately 45% of New England's generation at any time instant<sup>2</sup>, high gas transportation prices led consumers to pay substantially higher electricity prices in disproportion to the actual cost increases experienced by generation firms. In particular, consumers paid non-gas inframarginal firms, which accounted for at least 55% of all generation, high electricity prices driven by high gas prices despite the fact that these firms experienced *zero* direct cost increases.

---

<sup>2</sup> Converting daily gas deliveries to electricity produced using each generator's heat rate shows that gas-fired generation exceeded 45% of load in only three days during the four month study period.

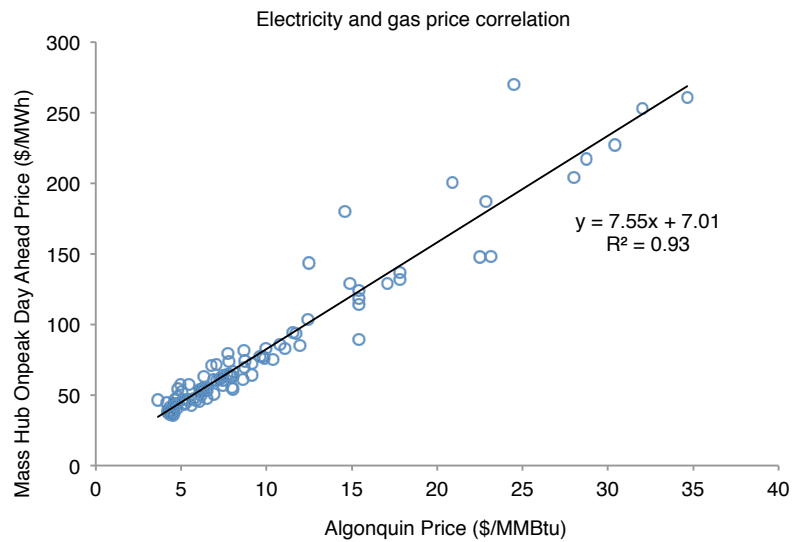

Figure 3: Daily Average On-Peak Day-Ahead price at Mass Hub versus Algonquin spot prices; Mass Hub prices downloaded from ISO-NE

## 2.2 Investment incentives for other market participants

In power systems where gas technologies frequently set the marginal electricity price, high transportation costs for natural gas can create substantial transfers from consumers to generation firms. Given this dynamic, gas generation firms appear to have little incentive to invest in long-term fuel transportation. Using the same Genscape NatGas Analyst dataset, we extend the empirical case study to analyze the investment incentives for three other key participants in New England's gas and electricity system: local distribution companies, third-party arbitrage investors, and electricity consumers. To explore how congestion rents and electricity prices might change under different pipeline scenarios, we also introduce a hypothetical scenario in which the pipeline capacity at Algonquin increases by 0.6 BCF per day (representing an addition of approximately 25% more capacity than is currently available).

**2.2.1 Gas Local Distribution Companies**

Local distribution companies (LDCs), because of their regulated monopolistic structure and mandate to ensure reliable gas supplies to their captive consumers, own a substantial fraction of long-term pipeline firm transmission rights. These firm transmission rights allow LDCs to hedge against high congestion prices on behalf of their consumers. Table 1 shows that while the price of natural gas for gas-fired power plants rose heading into the winter during the study period, the average price that residential customers paid for gas actually fell slightly. As long as LDCs have adequate firm transmission to serve their captive customers, they have little reason to purchase additional transmission capacity.

	9/1/2012	10/1/2012	11/1/2012	12/1/2012	1/1/2013	2/1/2013	3/1/2013
MA Residential	15.02	12.84	13.88	13.38	13.18	13.01	13.07
MA Electric	3.26	3.8	5.5	5.7	9.64	18.52	7.03
CT Residential	20.45	17.88	14.76	13.09	13.07	12.76	12.1
CT Electric	3.39	3.89	5.79	5.77	9.83	11.65	5.66

Table 1: EIA Monthly Average Gas Price By Customer Type (\$/MMBtu)

**2.2.2 Private Investors in New Pipeline Capacity**

Thus far, we have examined why firms that own gas-fired power plants and LDCs are unlikely to invest in new pipeline capacity despite high congestion prices. Participants in academic and regulatory settings such as (MITEI 2013) have often argued that one of the advantages of congestion pricing in spot markets is to provide transparent price signals for private investment. Given the substantial basis differential between Algonquin and Henry Hub, private investors (arbitrage agents) may have incentive to fund new pipeline construction into New England.

To examine how a private investor might collect congestion rents in New England, we start with the hypothetical pipeline expansion scenario in which the private investor funds 0.6 BCF of new pipeline capacity into the New England region (representing an addition of approximately 25% more pipeline capacity than is currently available at Algonquin). Assuming that the private investor's pipeline is fully scheduled during the study period, the private investor could receive, at most, approximately \$530 million in congestion rent by collecting  $(0.6 \text{ BCF/day}) \cdot (10^6 \text{ MMBtu} / \text{BCF}) \cdot (\$6.44/\text{MMBtu} \text{ difference between Algonquin and Henry}) \cdot (138 \text{ days in the study period})$ .

However, because building an additional 0.6 BCF of pipeline capacity would also likely suppress congestion prices, \$530 million is a generous upper bound estimate of congestion rents. We estimate how congestion prices might change by exploiting the fact that residential and commercial gas usage highly influences the availability of short-term pipeline capacity at Algonquin. Residential and commercial consumers share pipeline capacity with gas-fired generators, but are insensitive to spot prices because they pay a regulated tariff rate to their local LDC. LDCs, in turn, release any pipeline capacity that their customers do not need to other entities such as generation firms in secondary markets. Using this fact, we assume that citygate gas consumption is an independent variable that exogenously drives Algonquin spot prices and use citygate gas consumption data to estimate the Algonquin basis differential during the study period.

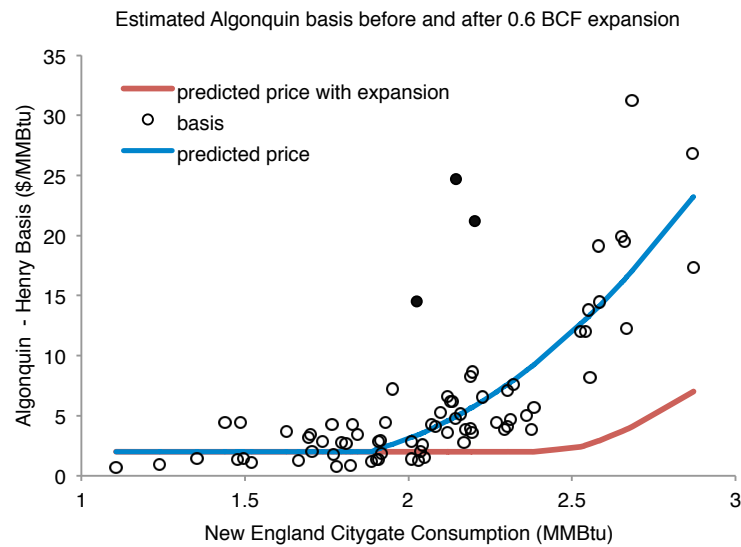

Figure 4: Relationship between citygate consumption and Algonquin basis pricing; black dots are daily actual observations, the blue line represents an imposed \$2/MMBtu constant basis differential and an exponentially fitted trend after removing three extreme outliers shown in black, and the red line represents the estimated differential with a 0.6 BCF per day upgrade.

The blue fitted line<sup>3</sup> in Figure 4 maps residential and commercial demand levels at the Massachusetts citygate to a specific Algonquin spot price based on actual observations. The fitted line imposes a \$2 constant premium for taking delivery of gas at Algonquin over taking delivery at Henry Hub, and the red line shows how congestion prices for Algonquin might change relative to citygate consumption with the hypothetical pipeline

---

<sup>3</sup> Three consecutive days in January were removed from the fit line because they fall well outside of the trend; however, if included, the fitted line would result in higher spot prices at Algonquin that would skew the estimate of congestion rents higher. Additionally, we only considered daily gas prices between Tuesday and Friday because Saturday through Monday trade as a single block contract. Lastly, we fixed the fit lines at a price of \$2/MMBtu for consumption levels below 1.8 BCF because prices appear to be somewhat insensitive to demand below this level.

expansion (the red trend line models the 0.6 BCF expansion by shifting every point on the blue curve rightward by 0.6 BCF). Under the hypothetical expansion scenario, due to lower congestion prices, a private investor that owned long-term transmission rights for the additional 0.6 BCF would likely only earn, at most, \$210 million in congestion rents instead of the original estimate of \$530 million.

Given the imprecise nature of this revenue estimate if an investor were to invest in 0.6 BCF of additional pipeline capacity at Algonquin, we probe for potential positive and negative biases by (1) examining the impact of the hypothetical expansion on spare pipeline capacity considering both Algonquin and TGP, the other major pipeline that connects the United States interstate pipeline system to New England; and (2) examining the frequency of pipeline scarcities at Algonquin that drove gas prices higher. Figure 5 graphs the total spare capacity for Algonquin and TGP versus the Algonquin basis. The plot shows that the combined spare capacity of both pipelines during the study period is always less than 0.6 BCF; consequently, the hypothetical situation of adding an additional 0.6 BCF of capacity at Algonquin would essentially double the region's spare capacity on low gas demand days and likely increase the number of unconstrained pipeline days, even considering the contribution of TGP's capacity.

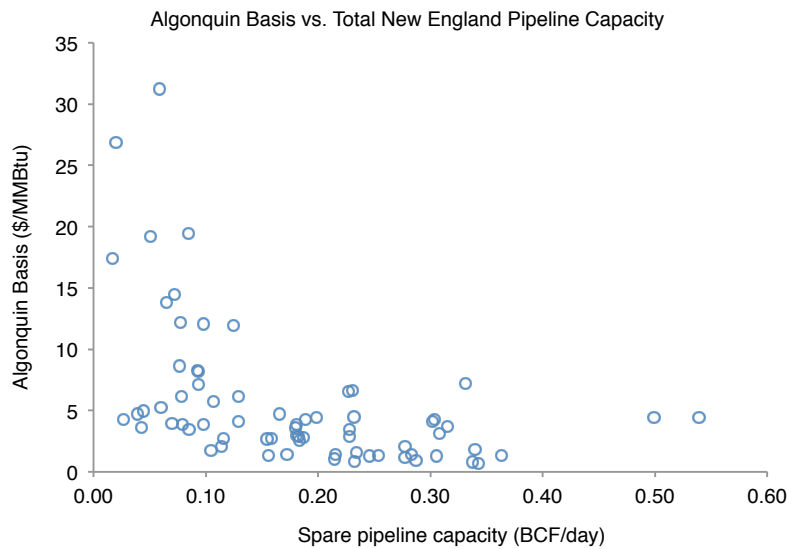

Figure 5: Algonquin basis versus sum of spare capacity on Algonquin and TGP,  
November 1, 2012 to March 20, 2013

Figure 6 shows two cumulative distribution functions that describe the percentage of time during the study period that the price of gas was less than or equal to a specific value. The cumulative distribution functions correspond to gas prices at Algonquin and at Transco-Z6, a hub in New York. Although congestion can clearly drive the New York basis well above Henry Hub, as shown by the red line, in the absence of congestion (about 60% of the days in the study period), the Transco-Z6 basis can fall under \$0.2/MMBtu. By contrast, Algonquin appears to constantly have congestion during the study period. An additional 0.6 BCF of transport capacity could potentially eliminate this constant level of congestion. In the context of estimating the Algonquin basis (Figure 4), an expansion of 0.6 BCF could potentially collapse the imposed \$2/MMBtu floor to levels similar to Transco's uncongested prices (\$0.1/MMBtu to \$0.4/MMBtu). Given the potential for a 0.6 BCF expansion to collapse the \$2/MMBtu floor at Algonquin, the



revenue estimate of \$210 million in congestion rents for a private investor represents a high upper bound.

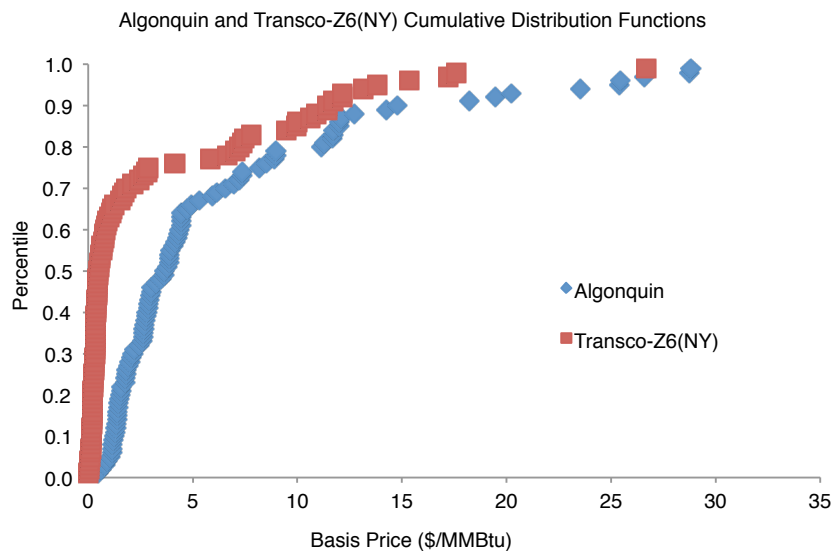

Figure 6: Cumulative distribution function of daily basis prices at Algonquin and Transco-Z6(NY), November 1, 2012 to March 20, 2013

In summary, although private investors may be able to earn money by investing in capacity to arbitrage the price difference between Algonquin and Henry Hub, the congestion rent that they can collect is inversely proportional to the amount of capacity that they (and others) invest in because additional capacity quickly reduces congestion rents and the frequency of pipeline scarcities. Consequently, although private investors have incentive to buy a small amount of long-term pipeline capacity, they will not buy enough to fully eliminate pipeline scarcities that drive electricity prices higher for consumers.

### 2.2.3 Electricity consumers

To estimate the cost impact of high gas prices to electricity consumers, we compared the cost of electricity and actual gas prices during the study period to the predicted cost of electricity assuming gas prices at nearby market centers in New York, New Jersey, and under the hypothetical 0.6 BCF Algonquin capacity investment scenario.

To estimate electricity prices using daily gas prices, we normalized a set of hourly electricity prices for one day based on that same day's gas price, and then scaled the normalized set by every actual daily gas price. Using this approximation, we performed two normalizations—one to represent electricity prices during on-peak gas demand days and one to represent electricity prices during off-peak gas demand days. Figures Figure 8 and Figure 8 compare the estimated prices to actual hourly pricing data over the study period.

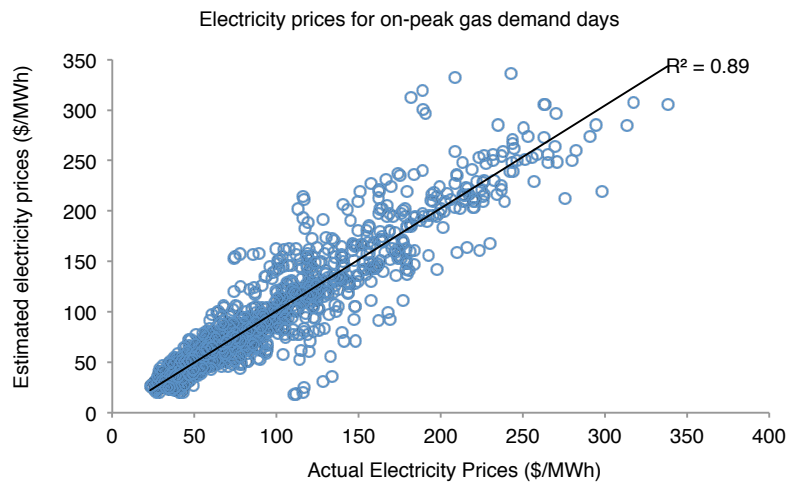

Figure 7: Estimated versus actual hourly electricity prices at Masshub during the study period

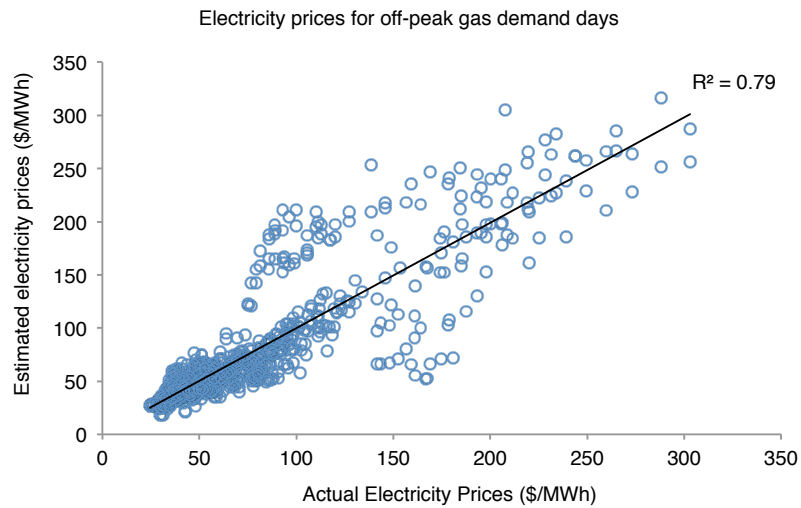

Figure 8: Estimated versus actual hourly electricity prices at Masshub during the study period

For both on-peak and off-peak days, the model makes reasonable predictions with  $R^2 = 0.88$  for on peak and  $R^2 = 0.79$  for off peak. Aggregating these estimated electricity prices

with electricity demand, consumers paid approximately \$3.3 billion for electricity<sup>4</sup> in New England during the case study period. Applying the same mapping functions to estimate electricity costs under different gas prices, Table 2 shows the cost savings that New England could have achieved over the study period had it received the gas prices at New Jersey (Tetco-M3), the gas prices at the New York city area (Transco Z6 (NY)), or the hypothetical Algonquin gas prices that would result from the 0.6 BCF expansion.

Gas Price	Dollars Saved (billions of \$)
New Jersey (Tetco-M3)	2.23
New York (Transco-Z6(NY))	1.08
40% Algonquin Basis	1.38

Table 2: Total New England electricity savings possible under different gas price scenarios based on geographically close market hubs and a hypothetical 0.6 BCF expansion at Algonquin

High gas prices clearly impact the cost of electricity for New England consumers. If New England could receive the same gas prices as New Jersey, consumers would have saved about \$2.2 billion over the study period. Even receiving New York City’s natural gas prices, which are higher than New Jersey’s but lower than Algonquin’s, would have saved approximately \$1.1 billion.<sup>5</sup>

---

<sup>4</sup> This cost is for energy only. It does not include other charges such as reserves and make-whole payments to generators dispatched out of merit for reliability.

<sup>5</sup> Gas delivered to citygates is primarily for residential and commercial heating, as well as small businesses that do not have direct pipeline connections. The Genscape dataset shows that all large combined-cycle power plants in New England have direct pipeline interconnections; thus, there is no double counting. Note that these “savings” represent savings to consumers—not deadweight loss. Although higher gas prices will

### 2.3 Case study summary

Congestion pricing for natural gas in New England imposed a substantial cost on consumers through higher electricity prices. Considering the hypothetical scenario of adding 0.6 BCF pipeline capacity to Algonquin, consumers in New England would have observed lower transportation costs on the order of 60% and electricity savings of approximately \$1.38 billion over the study period. However, if private investors were to fund this additional capacity, they could only collect approximately \$210 million in congestion rents over the same period.

The electricity costs imposed on consumers by pipeline scarcities and high gas transportation costs are far larger than the congestion rents that owners of physical transportation capacity can capture for three reasons. First, pipeline capacity owners only receive congestion rents based on the amount of capacity that they own. If a pipeline expansion comprises 15% of transmission capability, the owner only captures 15% of any congestion rents. Second, substantially improving transportation capacity will likely suppress congestion pricing and decrease profits from congestion rents. Third, high natural gas prices cost consumers far more than the increased cost of fuel for gas-fired generators because gas-fired generators produce less than 50% of the electricity, but almost always set the marginal price in New England. Consequently, consumers pay

---

undoubtedly lead to some deadweight loss from the dispatch of less efficient coal and oil generators, higher gas prices also lead to rent transfers between electricity consumers, generation firms, and owners of long-term transportation capacity.

more for electricity not just because they are paying for gas transportation, but also because they must pay all inframarginal generators—from New England's legacy oil and coal fleet, as well as any imported power—the elevated marginal electricity price.

Generation firms have little incentive to invest in pipeline capacity because they can benefit from high gas prices; LDCs only need to acquire enough pipeline capacity to meet the gas demand of their captive customers; and private investors are unable to capture much of the inframarginal rents that consumers pay due to pipeline scarcities. Consumers clearly would benefit from lower gas transportation costs. However, given the economies of scale of pipeline investments, individual consumers face a substantial collective action problem committing to long-term gas transportation. In section 3, we discuss this collective action problem in greater detail and review potential policy instruments that could address it.

### **3 Policy Implications**

The structure of the electricity and natural gas markets in New England results in high electricity prices to consumers, but limited incentives for private actors to commit to the long-term fuel transportation needed to fund new pipeline capacity for the following reasons. First, high gas prices can be beneficial to a generation firm's profits. Second, investment in long-term transportation capacity collapses high scarcity prices for gas transportation and discourages private investment. Third, consumers pay disproportionately more for electricity than the actual increased cost to generators due to high fuel costs (this benefits all inframarginal generators). And fourth, given the current gas and electricity market rules, there is no obvious business model that would allow a

third-party private agent to collect the extra costs paid by consumers in the electricity market resulting from high gas prices. Given these dynamics between gas and electricity markets, the large electricity costs that consumers pay due to high gas prices appear to represent a substantial welfare transfer from consumers to inframarginal generators and the original owners of long-term transportation capacity.

These price dynamics create the potential for a market failure because electricity consumers, the single group that would benefit most from increased pipeline capacity, are likely too dispersed to collectively purchase long term transportation contracts.<sup>6</sup> Pipeline investments are large, lumpy, and feature strong economies of scale. Given that pipeline investments have these economic features, electricity consumers as a group face a collective action problem with making a sufficiently large and long-term commitment for fuel transportation that would result in additional investment. Additionally, electricity consumers tend to purchase gas indirectly via the LDC that they are connected to. Within the deregulated natural gas and electricity framework, neither LDCs nor other government agencies traditionally have a mandate to purchase firm transmission for the private electric power sector, even if this purchase would provide net savings to their captive consumers.

In response to the lack of new investment in pipeline capacity, increasing reliability and affordability concerns, and the collective action problem that individual electricity

---

<sup>6</sup> Determining whether a market failure is actually occurring would require comparing the aggregate welfare gains to the cost of building a new pipeline, and this is beyond the scope of this paper.

consumers face in New England, the state of Maine recently passed LD 1559, “An Act To Reduce Energy Costs, Increase Energy Efficiency, Promote Electric System Reliability and Protect the Environment,” enabling its public utilities commission (PUC) to commit to purchasing long-term gas transportation capacity on behalf of consumers. In the bill, the Maine legislature notes that “it is in the public interest to decrease prices of electricity and natural gas for consumers in this State,” and that “the expansion of natural gas transmission capacity into this State and other states in the ISO-NE region could result in lower natural gas prices and, by extension, lower electricity prices for consumers in this State.” Maine’s actions support the idea that the substantial welfare transfer from consumers to generation firms and current owners of long-term gas transportation contracts may represent a welfare distribution and collective action problem in New England’s gas and electricity markets, and the state’s decision to grant its PUC the authority to invest in long-term pipeline capacity may signal a belief that under current market rules, private firms will not invest in pipeline capacity of their own accord. Our paper provides theoretical and empirical support for the Maine policy by identifying the key pathways by which high natural gas prices impose large costs on consumers, but provide little investment incentive to other actors.

#### **4 Conclusion**

Electric power systems are burning increasingly larger amounts of natural gas for environmental and economic reasons. Using an analytic model and an empirical case study of gas and electricity prices in New England during the winter of 2012, we showed that electric power systems in pipeline-constrained regions with gas-centric capacity mixes and wholesale electricity markets that operate under marginal pricing can produce



unexpected price dynamics. These price dynamics can improve the profits of generation firms while simultaneously limiting the scarcity rents that other private firms can collect, resulting in few incentives for any private firm to commit to long-term fuel transportation. Additionally, due to the large and lumpy nature of pipeline investments, electricity consumers are unlikely to commit to substantial quantities of long-term fuel transportation because they face a collective action problem, despite the fact that they stand to gain the most from lower gas transportation costs. Maine's passing of LD 1559, which gives the state's public utilities commission the explicit authority to commit to firm pipeline transmission if the purchase will provide a net benefit to consumers, represents a novel approach to overcoming the collective action problem and merits further consideration by other state legislatures and public utilities commissions as electric power and gas systems increasingly grow more coupled to one another.

## References

- Boiteux, M., 1960. Peak-Load Pricing. *The Journal of Business*, 33(2), pp.157–179.
- Caramanis, M.C., 1982. Investment Decisions and Long-Term Planning Under Electricity Spot Pricing. *IEEE Transactions on Power Apparatus and Systems*, 75(12), pp.4640–4648.
- Caramanis, M.C., Bohn, R.E. & Schweppe, F.C., 1982. Optimal Spot Pricing: Practice and Theory. *IEEE Transactions on Power Apparatus and Systems*, 75(9), pp.3234–3245.
- FERC, 2012. *Staff Report on Gas-Electric Coordination Technical Conferences (Docket No . AD12-12-000)*, Available at: <http://www.ferc.gov/legal/staff-reports/11-15-12-coordination.pdf>.
- ISO-New England, 2013. *2013 Regional System Plan*, Available at: [http://www.iso-ne.com/trans/rsp/2013/rsp13\\_final.docx](http://www.iso-ne.com/trans/rsp/2013/rsp13_final.docx).
- Juris, A., 1998. Development of Natural Gas and Pipeline Capacity Markets in the United States.
- Leahy, E. et al., 2012. The cost of natural gas shortages in Ireland. *Energy Policy*, 46, pp.153–169. Available at: <http://linkinghub.elsevier.com/retrieve/pii/S0301421512002522> [Accessed April 3, 2014].

- Lee, W.-W., 2004. US lessons for energy industry restructuring: based on natural gas and California electricity incidences. *Energy Policy*, 32(2), pp.237–259. Available at: <http://linkinghub.elsevier.com/retrieve/pii/S0301421502002872>.
- Makholm, J.D., 2006. *The Theory of Relationship-Specific Investments , Long-Term Contracts and Gas Pipeline Development in the United States 1*,
- MITEI, 2013. *Growing Concerns, Possible Solutions: The Interdependency of Natural Gas and Electricity Systems*, Cambridge, MA.
- Mwasinghe, M., 1981. Principles of Modern Electricity Pricing. *Proceedings of the IEEE*, 69(3).
- Perez-Arriaga, I.J. & Meseguer, C., 1997. Wholesale marginal prices in competitive generation markets. *IEEE Transactions on Power Systems*, 12(2), pp.710–717. Available at: <http://ieeexplore.ieee.org/lpdocs/epic03/wrapper.htm?arnumber=589661> [Accessed April 3, 2013].
- Petrash, J.M., 2005. Long-term Natural Gas Contracts: Dead, Dying, or Merely Resting? , (July), pp.545–582.
- Schweppe, F.C., 1987. *Spot pricing of electricity*, Boston: Kluwer Academic.
- Steiner, P., 1957. Peak Loads and Efficient Pricing. *The Quarterly Journal of Economics*, 71(4), pp.585–610.

Woo, C.-K. et al., 2006. Bi-directional causality in California's electricity and natural-gas markets. *Energy Policy*, 34(15), pp.2060–2070. Available at: <http://linkinghub.elsevier.com/retrieve/pii/S0301421505000819> [Accessed April 3, 2014].

# Appendix B

## Matlab and GAMS code

```

1 * dispatchSystemStates.gms
2 *
3 * This is the GAMS code for the system state unit commitment problem with
4 * long- and medium-term decisions.
5
6 $OFFLISTING
7 $INCLUDE AUTO_GENERATED/OPTIONS.gms
8
9 $INCLUDE STATIC_SETS.gms
10 $INCLUDE SYSTEMSTATES.gms
11
12 $INCLUDE POWERPLANTS.gms
13 $INCLUDE TIME.gms
14
15 $INCLUDE GAS.gms
16 $INCLUDE LTSA.gms
17 $INCLUDE FCM.gms
18 $INCLUDE AUTO_GENERATED/MAINTENANCE.gms
19
20 VARIABLES
21     totalCost                                objective value;
22
23 POSITIVE VARIABLES
24     x(q, s, pp, i)                          output of each power plant
25     w(q, s, pp, i)                          output of each power plant above its minimum
26
27     y(q, s, ss, pp, i)                      start up decision
28     z(q, s, ss, pp, i)                      shut down decision
29
30     fx_LT(g)                                long-term transportation commitment
31     fx_ST(q, dd, g)                         short-term transportation
32     f(q, dd, g)                             daily fuel use for electricity
33
34     starts(q, j)                            total starts
35     fh(q, j)                                total firing hours
36     umd(q, s, pp, j)                       product of binary variables u and md
37     mb(q, pp, j)                            variable to indicate maintenance
38     md(q, pp, j)                            maintenance duration
39     moc(q, j)                                maintenance cost
40
41     binaryCost(q)                           binary cost
42     gasGenCost(q, dd)                       daily gas generation cost
43     scenarioCost(q)                         individual scenario aggregate cost
44
45     fcc_gas(q, aa, g)                       maximum gas contribution to fcc decision
46     fcc_nongas(q, aa, g)                   maximum nongas contribution of fcc decision
47     fcc_j(q, dd, j)                         daily contribution of gas plant j to forward capacity
48     fcc_nj(q, dd, nj)                      daily contribution of non-gas plant nj to forward capacity
49     fcc(q, aa, g)                           anticipative forward capacity commitment
50
51     a_ST(q, dd, g)                          percentage of daily gas demand purchased in spot market
52     a_LT(q, g)                              percentage of daily gas demand covered by long-term contracts
53     a_min(g)                                actual, average percentage of gas met by long-term contracts
54     a_dummy(q, g)                           dummy variable
55
56     fcc_gas_NA(aa, g)                       nonanticipativity
57     fcc_j_NA(dd, j)                         nonanticipativity
58     fcc_NA(aa, g)                           nonanticipativity
59
60     mb_NA(pp, j)                            nonanticipativity;
61
62 SOS1 VARIABLE mc(j, l)                     maintenance contract selection;
63
64 BINARY VARIABLES
65     u(q, s, pp, i)                          commitment state;
66
67 INTEGER VARIABLES
68     efhAcc(q, pp, j)                        track accumulated equivalent firing hours;
69
70 EQUATIONS
71     objective                                define objective function
72     costD(q)                                individual scenario costs
73     costA(q, dd)                            cost of gas generators
74     costB(q)                                binary costs
75
76     eUMD1(q, s, pp, j)                      linearization of u * md
77     eUMD2(q, s, pp, j)                      linearization of u * md
78     eUMD3(q, s, pp, j)                      linearization of u * md
79
80     demand(q, s, pp)                        state demand balance
81     eGenerationA(q, s, pp, nj)              calculate generation levels for non-gas plants
82     eGenerationB(q, s, pp, j)              calculate generation levels for gas plants
83
84     commit(q, pp, s, ss, i)                 commitment state
85     commitB(q, s, ss, pp, i)                startup decision constraint
86     commitC(q, s, ss, pp, i)                shutdown decision constraint
87
88     eTechMax(q, s, pp, i)                   technical maximum output
89     eTechMin(q, s, pp, i)                   technical minimum output
90
91     eMaintMax(q, s, pp, j)                  maintenance duration
92     eMaintMin(q, s, pp, j)                  maintenance duration
93     eMaintPeriod(q, pp, j)                  maintenance duration
94
95     eDailyGasUsage(q, dd, g)                natural gas use for each day and scenario
96     eDailyTransportation(q, dd, g)          short-term fuel transportation required
97     ePipeline(q, dd)                        natural gas transportation limit
98
99     eCvarST(q, dd, g)                       daily fraction of gas demand met with short-term purchases
100    eCvarLT(q, g)                            average gas demand met with long-term purchases
101    eCvarTargetA(g)                          require firms to meet a fraction of gas demand with long-term purchases
102    eCvarTargetB(q, g)                       require firms to meet a fraction of gas demand with long-term purchases
103
104    eTotalFiringHours(q, j)                  total firing hours
105    eTotalStarts(q, j)                       total starts
106
107    eMaintMIF(q, j, l, h)                    LTSA MIF cost allocation

```

```

108     eMaintSOS(j)                                LTSA selection
109
110     eMaintEFHLower(q, pp, j)                    maintenance group assignment based on equivalent firing hours
111     eMaintEFHUpper(q, pp, j)                   maintenance group assignment based on equivalent firing hours
112     eMaintEFHStart(q, pp, j)                   maintenance start based on equivalent firing hours
113     eMaintIgnoreA(q, pp, j)
114     eMaintIgnoreB(q, pp, j)
115
116     eFCMTarget(q, aa)                           forward capacity target
117     eFCMMaxOfferA(q, aa, g)                     sum gas and nongas fwd. capacity offers
118     eFCMMaxOfferB(q, aa, g)                     do not allow NSE to make a forward capacity offer
119     eFCMMaxOfferC(q, aa, dd, g)                 aggregate non-gas forward capacity limit
120     eFCMMaxOfferD(q, dd, nj)                   individual non-gas maximum
121     eFCMGasA(q, aa, pp, dd, j)                 aggregate gas plant technical max
122     eFCMGasB(q, aa, dd, g)                     aggregate plant availability based on maintenance
123     eFCMGasC(q, dd, pp, g)                     aggregate gas plant availability based on gas supply
124     eFCMGasD(q, pp, dd, j)                     individual gas plant availability based on maintenance
125
126     eFCMNonanticipativityA(q, aa, g)
127     eFCMNonanticipativityB(q, aa, g)
128
129     eMaintNonanticipativity(q, pp, j);
130
131     objective..
132     totalCost
133     =E= sum((q), P_Q(q) * scenarioCost(q));
134
135     costD(q)..
136     scenarioCost(q)
137     =E= sum(dd, gasGenCost(q, dd))
138         + sum((s, pp, nj), x(q, s, pp, nj) * (C_4(nj) * HR(nj) + C_5(nj))
139             * STATE_DURATION_MONTHLY(q, pp, s))
140         + binaryCost(q)
141         + sum(j, moc(q, j))
142         + sum((nj, dd), fcc_nj(q, dd, nj) * C_4(nj) * HR(nj))
143         + sum((j, dd), fcc_j(q, dd, j) * C_7(dd) * HR(j));
144
145     costA(q, dd)..
146     gasGenCost(q, dd)
147     =E= sum(g, f(q, dd, g) * C_7(dd))
148         + sum(g, P_FX_LT * fx_LT(g))
149         + sum(g, C_8(q, dd) * fx_ST(q, dd, g));
150
151     costB(q)..
152     binaryCost(q)
153     =E= sum((s, pp, nj),
154         u(q, s, pp, nj) * C_3(nj) * STATE_DURATION_MONTHLY(q, pp, s)
155         + sum(ss, STATE_TRANSITIONS_MONTHLY(q, pp, s, ss) *
156             (y(q, s, ss, pp, nj) * C_1(nj)
157             + z(q, s, ss, pp, nj) * C_2(nj))))
158         + sum((s, pp, j),
159             umd(q, s, pp, j) * C_3(j) * STATE_DURATION_MONTHLY(q, pp, s)
160             + sum(ss, STATE_TRANSITIONS_MONTHLY(q, pp, s, ss) *
161                 (y(q, s, ss, pp, j) * C_1(j)
162                 + z(q, s, ss, pp, j) * C_2(j))));
163
164     eUMD1(q, s, pp, j)..
165     umd(q, s, pp, j) =L= u(q, s, pp, j);
166
167     eUMD2(q, s, pp, j)..
168     umd(q, s, pp, j) =L= 1 - md(q, pp, j);
169
170     eUMD3(q, s, pp, j)..
171     umd(q, s, pp, j) =G= u(q, s, pp, j) - md(q, pp, j);
172
173     demand(q, s, pp)..
174     sum(i, x(q, s, pp, i))
175     =E= ELECTRICITY_DEMAND(q, s) - WIND(q, s);
176
177     eGenerationA(q, s, pp, nj)..
178     x(q, s, pp, nj) =E= w(q, s, pp, nj) + X_MIN(nj) * u(q, s, pp, nj);
179
180     eGenerationB(q, s, pp, j)..
181     x(q, s, pp, j) =E= w(q, s, pp, j) + X_MIN(j) * u(q, s, pp, j);
182
183     eTechMax(q, s, pp, nj)..
184     x(q, s, pp, nj) =L= X_MAX(nj) * u(q, s, pp, nj);
185
186     eTechMin(q, s, pp, nj)..
187     x(q, s, pp, nj) =G= X_MIN(nj) * u(q, s, pp, nj);
188
189     eMaintMax(q, s, pp, j)..
190     x(q, s, pp, j) =L= X_MAX(j) * umd(q, s, pp, j);
191
192     eMaintMin(q, s, pp, j)..
193     x(q, s, pp, j) =G= X_MIN(j) * umd(q, s, pp, j);
194
195     eMaintPeriod(q, pp, j)..
196     md(q, pp, j)
197     =E= sum(ppp$( (ORD(ppp) <= ORD(pp)) AND (ORD(ppp) > (ORD(pp) - SMD))),
198         mb(q, ppp, j));
199
200     commit(q, pp, s, ss, i)..
201     u(q, ss, pp, i)
202     =E= u(q, s, pp, i) + y(q, s, ss, pp, i) - z(q, s, ss, pp, i);
203
204     commitB(q, s, ss, pp, i)..
205     y(q, s, ss, pp, i) =L= 1;
206
207     commitC(q, s, ss, pp, i)..
208     z(q, s, ss, pp, i) =L= 1;
209
210     eDailyGasUsage(q, dd, g)..
211     f(q, dd, g)
212     =E= sum((i, s, pp){dayToPeriod(dd, pp) AND FIRM(i, g) AND j(i)},
213         x(q, s, pp, i) * HR(i) * STATE_DURATION_DAILY(q, dd, s));
214

```

```

215 eDailyTransportation(q, dd, g)..
216     f(q, dd, g) =L= fx_ST(q, dd, g) + fx_LT(g);
217
218 ePipeline(q, dd)..
219     sum(g, fx_ST(q, dd, g)) =L= (PC - GD(q, dd));
220
221 eCvarST(q, dd, g){F_ESTIMATED(q, dd, g) NE 0}..
222     a_ST(q, dd, g) =G= 1 - (fx_LT(g) / F_ESTIMATED(q, dd, g));
223
224 eCvarLT(q, g)..
225     a_LT(q, g) =E= 1 - sum(dd, a_ST(q, dd, g) / CARD(dd));
226
227 eCvarTargetA(g)..
228     a_min(g) - sum(q, (P-Q(q) * a_dummy(q, g)) / (1 - BETA(g)))
229     =G= A_MIN_TARGET(g);
230
231 eCvarTargetB(q, g)..
232     a_dummy(q, g) =G= a_min(g) - a_LT(q, g);
233
234 eTotalFiringHours(q, j)..
235     fh(q, j) =E= sum(pp, sum(s, umd(q, s, pp, j) * STATE_DURATION_MONTHLY(q, pp, s)));
236
237 eTotalStarts(q, j)..
238     starts(q, j) =E= sum(pp, sum((s, ss), y(q, s, ss, pp, j) * STATE_TRANSITIONS_MONTHLY(q, pp, s, ss)));
239
240 eMaintMIF(q, j, l, h){ORD(h) < CARD(h)}..
241     starts(q, j) * C_6(l) * (LTSA(l, h, 'FH') - LTSA(l, h+1, 'FH'))
242     - fh(q, j) * C_6(l) * (LTSA(l, h, 'ST') - LTSA(l, h+1, 'ST'))
243     + moc(q, j) * (LTSA(l, h, 'ST') * LTSA(l, h+1, 'FH') - LTSA(l, h+1, 'ST') * LTSA(l, h, 'FH'))
244     =G= BIG_M_50000000 * (mc(j, l) - 1);
245
246 eMaintSOS(j)..
247     sum(l, mc(j, l)) =E= 1;
248
249 eMaintEFHLower(q, pp, j){maintenance(pp) and majorGasPlants(j)}..
250     efhAcc(q, pp, j) =G=
251     (sum((s, ss, ppp){ORD(pp) < ORD(pp)},
252     y(q, s, ss, ppp, j) * STATE_TRANSITIONS_MONTHLY(q, ppp, s, ss)) * (MFH / MST)
253     + sum((s, ppp){ORD(pp) < ORD(pp)},
254     umd(q, s, ppp, j) * STATE_DURATION_MONTHLY(q, ppp, s))
255     - MFH) / MFH;
256
257 eMaintEFHUpper(q, pp, j){maintenance(pp) and majorGasPlants(j)}..
258     efhAcc(q, pp, j) =L=
259     (sum((s, ss, ppp){ORD(pp) < ORD(pp)},
260     y(q, s, ss, ppp, j) * STATE_TRANSITIONS_MONTHLY(q, ppp, s, ss)) * (MFH / MST)
261     + sum((s, ppp){ORD(pp) < ORD(pp)},
262     umd(q, s, ppp, j) * STATE_DURATION_MONTHLY(q, ppp, s))) / MFH;
263
264 eMaintEFHStart(q, pp, j){maintenance(pp) and majorGasPlants(j)}..
265     mb(q, pp, j) =E= efhAcc(q, pp, j) - efhAcc(q, pp-1, j);
266
267 eMaintIgnoreA(q, pp, j){not majorGasPlants(j)}..
268     mb(q, pp, j) =E= 0;
269
270 eMaintIgnoreB(q, pp, j){not majorGasPlants(j)}..
271     efhAcc(q, pp, j) =E= 0;
272
273
274 * forward capacity market equations
275 eFCMTarget(q, aa)..
276     sum(g, fcc(q, aa, g)) =E= FCM(aa);
277
278 eFCMMaxOfferA(q, aa, g)..
279     fcc(q, aa, g) =L= fcc_nongas(q, aa, g) + fcc_gas(q, aa, g);
280
281 eFCMMaxOfferB(q, aa, g)..
282     fcc(q, aa, g) =G= 0;
283
284 eFCMMaxOfferC(q, aa, dd, g)..
285     fcc_nongas(q, aa, g){dayToYear(dd, aa)}
286     =L= sum(nj$FIRM(nj, g), fcc_nj(q, dd, nj));
287
288 eFCMMaxOfferD(q, dd, nj)..
289     fcc_nj(q, dd, nj) =L= X_MAX(nj);
290
291 eFCMGasA(q, aa, pp, dd, j)..
292     fcc_j(q, dd, j) =L= X_MAX(j) * (1 - md(q, pp, j){dayToPeriod(dd, pp)});
293
294 eFCMGasB(q, aa, dd, g)..
295     fcc_gas(q, aa, g){dayToYear(dd, aa)} =L= sum(j$FIRM(j, g), fcc_j(q, dd, j));
296
297 eFCMGasC(q, dd, pp, g){dayToPeriod(dd, pp)}..
298     sum(j$FIRM(j, g), fcc_j(q, dd, j) * HR(j)) * sum(s$[SHORTAGE(q, pp, s)], STATE_DURATION_DAILY(q, dd, s))
299     =L= fx_LT(g) + fx_ST(q, dd, g);
300
301 eFCMNonanticipativityA(q, aa, g)..
302     fcc(q, aa, g) =E= fcc_NA(aa, g);
303
304 eFCMNonanticipativityB(q, aa, g)..
305     fcc_gas(q, aa, g) =E= fcc_gas_NA(aa, g);
306
307 eMaintNonanticipativity(q, pp, j)..
308     mb(q, pp, j) =E= mb_NA(pp, j);
309
310 $IFTHEN "%LONG_TERM%" == "YES"
311
312 * form long-term model
313 MODEL longTerm / objective, costD, costA, costB,
314     eUMD1, eUMD2, eUMD3,
315     demand, eGenerationA, eGenerationB,
316     commit, commitB, commitC,
317     eTechMax, eTechMin,
318     eMaintMax, eMaintMin, eMaintPeriod,
319     eDailyGasUsage, eDailyTransportation, ePipeline,
320     eTotalFiringHours, eTotalStarts,
321     eMaintMIF, eMaintSOS,

```



```

322         eMaintEFHLower, eMaintEFHUpper, eMaintEFHStart,
323         eMaintIgnoreA, eMaintIgnoreB,
324         eFCMTarget, eFCMMaxOfferA, eFCMMaxOfferB, eFCMMaxOfferC, eFCMMaxOfferD,
325         eFCMGasA, eFCMGasB, eFCMGasC,
326         eCvarST, eCvarLT, eCvarTargetA, eCvarTargetB,
327         eFCMNonanticipativityA, eFCMNonanticipativityB /;
328     eMaintNonanticipativity /;
329
330     longTerm.optfile = 0;
331     longTerm.threads = -1;
332
333     * declare output files
334     FILE results_objective_lt / 'results_objective_lt.csv' /;
335     put results_objective_lt;
336     put "P_FX_LT, E[totalCost]";
337     put /;
338
339     FILE results_fx_lt / 'results_fx_lt.csv' /;
340     put results_fx_lt;
341     results_fx_lt.pw = 32767;
342     put "g,P_FX_LT,fx_LT";
343     put /;
344
345     FILE results_mc / 'results_mc.csv' /;
346     put results_mc;
347     results_mc.pw = 32767;
348     put "j, P_FX_LT, mc(1), mc(2)"
349     put /;
350
351     FILE results_fcm_lt / 'results_fcm_lt.csv' /;
352     put results_fcm_lt;
353     results_fcm_lt.pw = 32767;
354     put "q, a, g, P_FX_LT, fcc, x_max, marginalPrice";
355     put /;
356
357     FILE results_maintenance_lt / 'results_maintenance_lt.csv' /;
358     put results_maintenance_lt;
359     results_maintenance_lt.pw = 32767;
360     put "q, P_FX_LT, j, MOC, firing hours, starts";
361     put /;
362
363     FILE results_availableGasCapacity_lt / 'results_availableGasCapacity_lt.csv' /;
364     put results_availableGasCapacity_lt;
365     results_availableGasCapacity_lt.pw = 32767;
366     put "q, P_FX_LT, p, g, gasFiredCapacity";
367     put /;
368
369     FILE results_fuelUsage_lt / 'results_fuelUsage_lt.csv' /;
370     put results_fuelUsage_lt;
371     results_fuelUsage_lt.pw = 32767;
372     put "q, PT_FX_LT, day, firm, f, f_LT, f_ST";
373     put /;
374
375     FILE results_generation_lt / 'results_generation_lt.csv' /;
376     put results_generation_lt;
377     results_generation_lt.pw = 32767;
378     put "q, P_FX_LT, p, g, output";
379     put /;
380
381     FILE results_generation_marginal_prices_lt / 'results_generation_marginal_prices_lt.csv' /;
382     put results_generation_marginal_prices_lt;
383     results_generation_marginal_prices_lt.pw = 32767;
384     put "q, P_FX_LT, p, s, marginal price, time duration";
385     put /;
386
387     FILE results_profits_lt / 'results_profits_lt.csv' /;
388     put results_profits_lt;
389     results_profits_lt.pw = 32767;
390     put "P_FX_LT, g, energy revenue, nonconvex costs, gas costs, non-gas costs, forward capacity revenue";
391     put /;
392
393     FILE results_miscellaneous / 'results_miscellaneous.csv' /;
394     put results_miscellaneous;
395     results_miscellaneous.pw = 32767;
396
397     FILE results_riskAversion / 'results_riskAversion.csv' /;
398     put results_riskAversion;
399     results_riskAversion.pw = 32767;
400     put "P_FX_LT, alpha, beta, g, fx_lt";
401     put /;
402
403     SET ALPHA_INDEX / 1 /;
404     SET BETA_INDEX / 1, 5, 9 /;
405
406     PARAMETER ALPHA_VALUES(ALPHA_INDEX)
407     /
408     1 0.2
409     *2 0.5
410     *3 0.9
411     /;
412
413     PARAMETER BETA_VALUES(BETA_INDEX)
414     /
415     1 0.1
416     * 2 0.2
417     * 3 0.3
418     * 4 0.4
419     5 0.5
420     * 6 0.6
421     * 7 0.7
422     * 8 0.8
423     9 0.9
424     /;
425
426     loop(P_FX_LT_INDEX,
427
428     * pull out long-term transportation price for this set of runs

```

```

429         P_FX_LT = P_FX_LT_RANGE(P_FX_LT_INDEX);
430
431     Loop (ALPHA_INDEX,
432         loop (BETA_INDEX,
433             loop(g,
434                 A_MIN_TARGET(g) = ALPHA_VALUES(ALPHA_INDEX);
435                 A_MIN_TARGET(g) = ALPHA_VALUES(ALPHA_INDEX);
436                 BETA(g) = BETA_VALUES(BETA_INDEX);
437                 BETA(g) = BETA_VALUES(BETA_INDEX);
438                 );
439
440     * model execution
441     SOLVE longTerm USING MIP MINIMIZING totalCost;
442
443     put results_riskAversion;
444     loop(g,
445         put P_FX_LT;
446         put " ";
447         put ALPHA_VALUES(ALPHA_INDEX);
448         put " ";
449         put BETA_VALUES(BETA_INDEX);
450         put " ";
451         put g.tl;
452         put " ";
453         put fx_LT.l(g);
454         put /;
455     );
456
457     );
458
459
460 * write out the objective value
461 put results_objective_lt;
462 put P_FX_LT;
463 put " ";
464 put totalCost.l;
465 put /;
466
467 * write out long-term fuel commitments
468 put results_fx_lt;
469 loop(g,
470     put g.tl;
471     put " ";
472     put P_FX_LT;
473     put " ";
474     put fx_LT.l(g);
475     put /;
476 );
477
478 * write out long-term maintenance decisions
479 put results_mc;
480 loop(j,
481     put j.tl;
482     put " ";
483     put P_FX_LT;
484     put " ";
485     loop(l${ORD(l) EQ 1},
486         put mc.l(j,l);
487         put " ");
488     loop(l${ORD(l) EQ 2},
489         put mc.l(j,l));
490     put /;
491 );
492
493 * write out annual forward capacity commitments and marginal prices
494 put results_fcm_lt;
495
496 loop(q,
497     loop(aa,
498         loop(g,
499             put q.tl;
500             put " ";
501             put aa.tl;
502             put " ";
503             put g.tl;
504             put " ";
505             put P_FX_LT_RANGE(P_FX_LT_INDEX);
506             put " ";
507             put fcc.l(q, aa, g);
508             put " ";
509             put sum(i${FIRM(i, g)}, X_MAX(i));
510             put " ";
511             put eFCMTarget.m(q, aa);
512             put /;
513         );
514     );
515 );
516
517 * write out maintenance results
518 put results_maintenance_lt;
519
520 loop(q,
521     loop(j,
522         put q.tl;
523         put " ";
524         put P_FX_LT_RANGE(P_FX_LT_INDEX);
525         put " ";
526         put j.tl;
527         put " ";
528         put moc.l(q, j);
529         put " ";
530         put sum((s, pp), umd.l(q, s, pp, j) * STATE_DURATION_MONTHLY(q, pp, s));
531         put " ";
532         put sum((s, ss, pp), y.l(q, s, ss, pp, j) * STATE_TRANSITIONS_MONTHLY(q, pp, s, ss));
533         put /;
534     );
535 );

```

```

536
537 * write out available gas generation capacity
538   put results_availableGasCapacity_lt;
539
540   loop(q,
541     loop(pp,
542       loop(g,
543         put q.tl;
544         put ",";
545         put P_FX_LT_RANGE(P_FX_LT_INDEX);
546         put ",";
547         put pp.tl;
548         put ",";
549         put g.tl;
550         put ",";
551         put sum(j${FIRM(j, g)}, X_MAX(j) * (1-md.l(q, pp, j)));
552         put /;
553         );
554       );
555     );
556
557 * write out fuel usage
558   put results_fuelUsage_lt;
559
560   loop(q,
561     loop(dd,
562       loop(g,
563         put q.tl;
564         put ",";
565         put P_FX_LT_RANGE(P_FX_LT_INDEX);
566         put ",";
567         put dd.tl;
568         put ",";
569         put g.tl;
570         put ",";
571         put f.l(q, dd, g);
572         put ",";
573         put fx_LT.l(g);
574         put ",";
575         put fx_ST.l(q, dd, g);
576         put /;
577         );
578     );
579
580
581 * write out power plant generation levels
582   put results_generation_lt;
583
584   loop(q,
585     loop(pp,
586       loop(g,
587         put q.tl;
588         put ",";
589         put P_FX_LT_RANGE(P_FX_LT_INDEX);
590         put ",";
591         put pp.tl;
592         put ",";
593         put g.tl;
594         put ",";
595         put sum((s, i)$FIRM(i, g), x.l(q, s, pp, i) * u.l(q, s, pp, i) * STATE_DURATION_MONTHLY(q, pp, s));
596         put /;
597         );
598     );
599
600
601 * write out marginal prices for energy
602   put results_generation_marginal_prices_lt;
603
604   loop(q,
605     loop(pp,
606       loop(s,
607         put q.tl;
608         put ",";
609         put P_FX_LT_RANGE(P_FX_LT_INDEX);
610         put ",";
611         put pp.tl;
612         put ",";
613         put s.tl;
614         put ",";
615         put demand.m(q, s, pp);
616         put ",";
617         put STATE_DURATION_MONTHLY(q, pp, s);
618         put /;
619         );
620     );
621
622
623   put results_profits_lt;
624
625   loop(g,
626     put P_FX_LT_RANGE(P_FX_LT_INDEX);
627     put ",";
628     put g.tl;
629     put ",";
630     put sum((q, pp, s, i)$FIRM(i, g),
631       P_Q(q) * x.l(q, s, pp, i) * u.l(q, s, pp, i) * demand.m(q, s, pp));
632     put ",";
633     put sum(q, P_Q(q) * (sum((s, pp, nj)$FIRM(nj, g),
634       u.l(q, s, pp, nj) * C_3(nj) * STATE_DURATION_MONTHLY(q, pp, s)
635       + sum(ss, STATE_TRANSITIONS_MONTHLY(q, pp, s, ss) *
636         (y.l(q, s, ss, pp, nj) * C_1(nj)
637         + z.l(q, s, ss, pp, nj) * C_2(nj))))
638       + sum((s, pp, j)$FIRM(j, g),
639         umd.l(q, s, pp, j) * C_3(j) * STATE_DURATION_MONTHLY(q, pp, s)
640         + sum(ss, STATE_TRANSITIONS_MONTHLY(q, pp, s, ss) *
641           (y.l(q, s, ss, pp, j) * C_1(j)
642           + z.l(q, s, ss, pp, j) * C_2(j))))));

```

```

643         put ", ";
644         put sum((q, dd), P_Q(q) * (f.l(q, dd, g) * C_7(dd) + P_FX_LT * fx_LT.l(g)));
645         put ", ";
646         put sum(q, P_Q(q) * (sum((s, pp, nj)$FIRM(nj, g),
647                                x.l(q, s, pp, nj) * (C_4(nj) * HR(nj) + C_5(nj)) * STATE_DURATION_MONTHLY(q, pp, s))
648                                + sum(j$FIRM(j, g), moc.l(q, j))));
649         put ", ";
650         put sum((q, aa), P_Q(q) * fcc.l(q, aa, g) * eFCMTarget.m(q, aa));
651         put /;
652     );
653
654 * miscellaneous results
655     put results_miscellaneous;
656
657     put "fuel constraint dual variable";
658     put /;
659     loop(q,
660         loop(dd,
661             put q.tl;
662             put ", ";
663             put P_FX_LT;
664             put ", ";
665             put dd.tl;
666             put ", ";
667             put ePipeline.m(q, dd);
668             put /;
669         );
670     );
671     put //;
672
673     put "maintenance start";
674     put /;
675     loop(q,
676         loop(j,
677             put q.tl;
678             put ", ";
679             put j.tl;
680             put ", ";
681             put P_FX_LT;
682             put ", ";
683             loop(pp,
684                 put mb.l(q, pp, j);
685                 put ", ";
686             );
687             put /;
688         );
689     );
690     put //;
691
692     put "maintenance duration";
693     put /;
694     loop(q,
695         loop(j,
696             put q.tl;
697             put ", ";
698             put j.tl;
699             put ", ";
700             put P_FX_LT;
701             put ", ";
702             loop(pp,
703                 put md.l(q, pp, j);
704                 put ", ";
705             );
706             put /;
707         );
708     );
709     put //;
710 );
711
712 putclose results_objective_lt;
713 putclose results_fx_lt;
714 putclose results_mc;
715 putclose results_fcm_lt;
716 putclose results_maintenance_lt;
717 putclose results_availableGasCapacity_lt;
718 putclose results_fuelUsage_lt;
719 putclose results_generation_lt;
720 putclose results_profits_lt;
721 putclose results_miscellaneous;
722
723 $ELSE
724
725 * form medium-term model
726 MODEL mediumTerm / objective, costD, costA, costB,
727                    eUMD1, eUMD2, eUMD3,
728                    demand, eGenerationA, eGenerationB,
729                    commit, commitB, commitC,
730                    eTechMax, eTechMin,
731                    eMaintMax, eMaintMin, eMaintPeriod,
732                    eDailyGasUsage, eDailyTransportation, ePipeline,
733                    eTotalFiringHours, eTotalStarts,
734                    eMaintMIF, eMaintSOS,
735                    eMaintEFHLower, eMaintEFHUpper, eMaintEFHStart,
736                    eMaintIgnoreA, eMaintIgnoreB,
737                    eFCMTarget, eFCMMaxOfferA, eFCMMaxOfferB, eFCMMaxOfferC, eFCMMaxOfferD,
738                    eFCMGasA, eFCMGasB, eFCMGasC,
739                    eFCMNonanticipativityA, eFCMNonanticipativityB, eMaintNonanticipativity //;
740
741 mediumTerm.optfile = 0;
742 mediumTerm.threads = -1;
743
744 $onecho > cplex.opt
745 $offecho
746
747 * declare output files
748 FILE results_objective / 'results_objective.csv' //;
749 put results_objective;

```

```

750 results_objective.pw = 32767;
751 put "P_FX_LT, E[totalCost]";
752 put /;
753
754 FILE results_fcm / 'results_fcm.csv' /;
755 put results_fcm;
756 results_fcm.pw = 32767;
757 put "q, a, g, P_FX_LT, fcc, x_max, marginal price";
758 put /;
759
760 FILE results_maintenance / 'results_maintenance.csv' /;
761 put results_maintenance;
762 results_maintenance.pw = 32767;
763 put "q, P_FX_LT, j, MOC, firing hours, starts";
764 put /;
765
766 FILE results_availableGasCapacity / 'results_availableGasCapacity.csv' /;
767 put results_availableGasCapacity;
768 results_availableGasCapacity.pw = 32767;
769 put "q, P_FX_LT, p, g, gasFiredCapacity";
770 put /;
771
772 FILE results_fuelUsage / 'results_fuelUsage.csv' /;
773 put results_fuelUsage;
774 results_fuelUsage.pw = 32767;
775 put "q, PT_FX_LT, day, firm, f, f_LT, f_ST";
776 put /;
777
778 FILE results_generation / 'results_generation.csv' /;
779 put results_generation;
780 results_generation.pw = 32767;
781 put "q, P_FX_LT, p, g, output";
782 put /;
783
784 FILE results_generation_marginal_prices / 'results_generation_marginal_prices.csv' /;
785 put results_generation_marginal_prices;
786 results_generation_marginal_prices.pw = 32767;
787 put "q, P_FX_LT, p, s, marginal price, time duration";
788 put /;
789
790 FILE results_profits / 'results_profits.csv' /;
791 put results_profits;
792 results_profits.pw = 32767;
793 put "P_FX_LT, g, energy revenue, nonconvex costs, gas costs, non-gas costs, forward capacity revenue";
794 put /;
795
796 loop(P_FX_LT_INDEX,
797
798 * fix long-term variables
799     fx_LT.fx(g) = SOLVED_FX_LT(P_FX_LT_INDEX, g);
800     mc.fx(j, l) = SOLVED_MC(P_FX_LT_INDEX, j, l);
801
802 * solve the medium-term model
803     SOLVE mediumTerm USING MIP MINIMIZING totalCost;
804
805 * write out the objective value
806     put results_objective;
807     put P_FX_LT;
808     put ",";
809     put totalCost.l;
810     put /;
811
812 * write out annual forward capacity commitments
813     put results_fcm;
814
815     loop(q,
816         loop(aa,
817             loop(g,
818                 put q.tl;
819                 put ",";
820                 put aa.tl;
821                 put ",";
822                 put g.tl;
823                 put ",";
824                 put P_FX_LT_RANGE(P_FX_LT_INDEX);
825                 put ",";
826                 put fcc_NA.l(aa, g);
827                 put ",";
828                 put sum(i$[FIRM(i, g)], X_MAX(i));
829                 put ",";
830                 put eFCMTarget.m(q, aa);
831                 put /;
832             );
833         );
834     );
835
836 * write out maintenance results
837     put results_maintenance;
838
839     loop(q,
840         loop(j,
841             put q.tl;
842             put ",";
843             put P_FX_LT_RANGE(P_FX_LT_INDEX);
844             put ",";
845             put j.tl;
846             put ",";
847             put moc.l(q, j);
848             put ",";
849             put sum((s, pp), umd.l(q, s, pp, j) * STATE_DURATION_MONTHLY(q, pp, s));
850             put ",";
851             put sum((s, ss, pp), y.l(q, s, ss, pp, j) * STATE_TRANSITIONS_MONTHLY(q, pp, s, ss));
852             put /;
853         );
854     );
855
856 * write out available gas generation capacity

```

```

857     put results_availableGasCapacity;
858
859     loop(q,
860         loop(pp,
861             loop(g,
862                 put q.tl;
863                 put ",";
864                 put P_FX_LT_RANGE(P_FX_LT_INDEX);
865                 put ",";
866                 put pp.tl;
867                 put ",";
868                 put g.tl;
869                 put ",";
870                 put sum(j${FIRM(j, g)}, X_MAX(j) * (1-md.l(q, pp, j)));
871                 put /;
872                 );
873             );
874         );
875
876 * write out fuel usage
877     put results_fuelUsage;
878
879     loop(q,
880         loop(dd,
881             loop(g,
882                 put q.tl;
883                 put ",";
884                 put P_FX_LT_RANGE(P_FX_LT_INDEX);
885                 put ",";
886                 put dd.tl;
887                 put ",";
888                 put g.tl;
889                 put ",";
890                 put f.l(q, dd, g);
891                 put ",";
892                 put fx_LT.l(g);
893                 put ",";
894                 put fx_ST.l(q, dd, g);
895                 put /;
896                 );
897             );
898         );
899
900 * write out power plant generation levels
901     put results_generation;
902
903     loop(q,
904         loop(pp,
905             loop(g,
906                 put q.tl;
907                 put ",";
908                 put P_FX_LT_RANGE(P_FX_LT_INDEX);
909                 put ",";
910                 put pp.tl;
911                 put ",";
912                 put g.tl;
913                 put ",";
914                 put sum((s, i)$FIRM(i, g), x.l(q, s, pp, i) * u.l(q, s, pp, i) * STATE_DURATION_MONTHLY(q, pp, s));
915                 put /;
916                 );
917             );
918         );
919
920 * write out marginal prices for energy
921     put results_generation_marginal_prices;
922
923     loop(q,
924         loop(pp,
925             loop(s,
926                 put q.tl;
927                 put ",";
928                 put P_FX_LT_RANGE(P_FX_LT_INDEX);
929                 put ",";
930                 put pp.tl;
931                 put ",";
932                 put s.tl;
933                 put ",";
934                 put demand.m(q, s, pp);
935                 put ",";
936                 put STATE_DURATION_MONTHLY(q, pp, s);
937                 put /;
938                 );
939             );
940         );
941
942 * write out profits
943     put results_profits;
944
945     loop(g,
946         put P_FX_LT_RANGE(P_FX_LT_INDEX);
947         put ",";
948         put g.tl;
949         put ",";
950         put sum((q, pp, s, i)$FIRM(i, g),
951             P_Q(q) * x.l(q, s, pp, i) * u.l(q, s, pp, i) * demand.m(q, s, pp));
952         put ",";
953         put sum(q, P_Q(q) * (sum((s, pp, nj)$FIRM(nj, g),
954             u.l(q, s, pp, nj) * C_3(nj) * STATE_DURATION_MONTHLY(q, pp, s)
955             + sum(ss, STATE_TRANSITIONS_MONTHLY(q, pp, s, ss) *
956                 (y.l(q, s, ss, pp, nj) * C_1(nj)
957                 + z.l(q, s, ss, pp, nj) * C_2(nj))))
958             + sum((s, pp, j)$FIRM(j, g),
959                 umd.l(q, s, pp, j) * C_3(j) * STATE_DURATION_MONTHLY(q, pp, s)
960                 + sum(ss, STATE_TRANSITIONS_MONTHLY(q, pp, s, ss) *
961                     (y.l(q, s, ss, pp, j) * C_1(j)
962                     + z.l(q, s, ss, pp, j) * C_2(j))))));
963     );

```

```

964         put ", ";
965         put sum((q, dd), P_Q(q) * (f.l(q, dd, g) * C_7(dd) + P_FX_LT * fx_LT.l(g)));
966         put ", ";
967         put sum(q, P_Q(q) * (sum((s, pp, nj)$FIRM(nj, g),
968                                x.l(q, s, pp, nj) * (C_4(nj) * HR(nj) + C_5(nj)) * STATE_DURATION_MONTHLY(q, pp, s))
969                                + sum(j$FIRM(j, g), moc.l(q, j))));
970         put ", ";
971         put sum((q, aa), P_Q(q) * fcc.l(q, aa, g) * eFCMTarget.m(q, aa));
972         put /;
973     );
974
975
976 );
977
978 putclose results_objective;
979 putclose results_fcm;
980 putclose results_maintenance;
981 putclose results_availableGasCapacity;
982 putclose results_fuelUsage;
983 putclose results_generation;
984 putclose results_profits;
985
986 $ENDIF

```

```

1  OPTION optcr = 0.001;
2  OPTION RESLIM = 10000000;
3  OPTION ITERLIM = 100000000;
4
5  $OFFLISTING
6  $INCLUDE SETS.gms
7  $INCLUDE POWERPLANTS.gms
8  $INCLUDE GAS.gms
9  $INCLUDE SCENARIOS.gms
10 $INCLUDE DEMAND.gms
11 $INCLUDE TIME.gms
12
13 VARIABLES
14     x(kk, nn, tt, i)          total output of each power plant
15     w(kk, nn, tt, i)          output of each power plant above its minimum
16
17     y(kk, nn, tt, i)          start decision
18     z(kk, nn, tt, i)          shut down decision
19     u(kk, nn, tt, i)          commitment state
20
21     f(kk, nn, dd, g)          daily gas usage per firm
22     fx_ST(kk, nn, dd, g)      short-term transportation per firm
23     fx_LT(g)                  long-term transportation per firm
24
25     fh_uc(kk, nn, tt, j)      total firing hours
26     s_uc(kk, nn, tt, j)       total starts
27     moc_uc(kk, nn, j)         maintenance cost of plant j
28     mS(kk, nn, tt, j)         track accumulated starts since the last maintenance
29     mF(kk, nn, tt, j)         track accumulated firing hours since the last maintenance
30     mb(kk, nn, tt, j)         binary variable to indicate maintenance
31     mc(j)                     maintenance contract selection
32     md(kk, nn, tt, j)         maintenance duration
33
34     binaryCost(kk, nn)        binary cost
35     gasGenCost(kk, nn, dd)    daily gas generation cost
36     scenarioCost(kk, nn)     individual scenario aggregate cost
37     totalCost                  total cost;
38
39 POSITIVE VARIABLE x, w, y, z, f, fx_ST, fx_LT, mS, mF, md, fh_uc, s_uc, moc_uc;
40 BINARY VARIABLE u, mb, mc;
41
42 EQUATIONS
43     objective                  define objective function
44     costD(kk,nn)              individual scenario costs
45     costA(kk, nn, dd)         cost of gas generators
46     costB(kk, nn)            binary costs
47     costM(kk, nn)            maintenance costs
48
49     demand(kk, nn, tt)       hourly demand
50     eGeneration(kk, nn, tt, i) calculate hourly individual plant generation levels
51
52     commit(kk, nn, tt, i)     commitment decision
53     commitB(kk, nn, tt, i)    constrain start variable between 0 and 1
54     commitC(kk, nn, tt, i)    constrain stop variable between 0 and 1
55
56     eTechMin(kk, nn, tt, i)   minimum output constraints
57     eTechMax(kk, nn, tt, i)   maximum output constraints
58
59     eMaintMax(kk, nn, tt, j)  maintenance duration
60     eMaintMin(kk, nn, tt, j)  maintenance duration
61     eMaintPeriod(kk, nn, tt, j) maintenance duration
62
63     * eTotalFH(kk, nn, j)      total firing hours
64     * eTotalS(kk, nn, j)      total starts
65     * eMaintCost(kk, nn, j)   maintenance cost
66
67     eMaxDownRamp(kk, nn, tt, i) minimum ramp constraints
68     eMaxUpRamp(kk, nn, tt, i)  maximum ramp constraints
69     eMinUpTime(kk, nn, tt, i)  minimum down time
70     eMinDownTime(kk, nn, tt, i) minimum up time
71
72     dailyGasUsage(kk, nn, dd, g) daily gas usage
73     dailyTransportation(kk,nn,dd,g) short-term fuel transportation required
74     pipeline(kk, nn, dd)       natural gas transportation limit
75
76     startsLimit(kk, nn, tt, j) start limit for power plants
77     startsAcc(kk, nn, tt, j)   accumulator positivity constraint
78     hoursLimit(kk, nn, tt, j)  hours limit for power plants
79     hoursAcc(kk, nn, tt, j)    accumulator positivity constraint
80     maintStart(kk, nn, tt, j)  maintenance schedule based on starts
81     maintHours(kk, nn, tt, j)  maintenance schedule based on firing hours
82
83
84
85     objective..
86         totalCost =E= sum((kk, nn), P_K(kk) * P_N(nn) * scenarioCost(kk, nn));
87
88     costD(kk, nn)..
89         scenarioCost(kk, nn)
90         =E= sum((tt, nj), x(kk, nn, tt, nj) * (C.4(nj) * H(nj) + C.5(nj)))
91             + sum(dd, gasGenCost(kk, nn, dd))
92             + sum(g, P_FX_LT * fx_LT(g))
93             + binaryCost(kk, nn);
94
95     costA(kk, nn, dd)..
96         gasGenCost(kk, nn, dd)
97         =E= sum((tt, j)$hourToday(tt, dd), x(kk, nn, tt, j) * H(j) * C.7(dd))
98             + sum(g, fx_ST(kk, nn, dd, g)) * C.8;
99
100    costB(kk, nn)..
101        binaryCost(kk, nn)
102        =E= sum((i, tt),
103            u(kk, nn, tt, i) * C.3(i)
104            + y(kk, nn, tt, i) * C.1(i)
105            + z(kk, nn, tt, i) * C.2(i))
106            + sum((tt, j), mB(kk, nn, tt, j) * C.6
107                - mS(kk, nn, tt, j) - mF(kk, nn, tt, j));

```



```

108
109 * costM(kk, nn)..
110 *     maintenanceCost(kk, nn)
111 *     =E= sum(j, moc_uc(kk, nn, j));
112
113 demand(kk, nn, tt)..
114 *     sum(i, x(kk, nn, tt, i)) =E= ED(tt, 'DEMAND') - ED(tt, 'WIND');
115
116 eGeneration(kk, nn, tt, i)..
117 *     x(kk, nn, tt, i) =E= w(kk, nn, tt, i) + u(kk, nn, tt, i) * X_MIN(i);
118
119 eTechMax(kk, nn, tt, i)..
120 *     x(kk, nn, tt, i) =L= u(kk, nn, tt, i) * X_MAX(i);
121
122 eTechMin(kk, nn, tt, i)..
123 *     x(kk, nn, tt, i) =G= u(kk, nn, tt, i) * X_MIN(i);
124
125 eMaintMax(kk, nn, tt, j)..
126 *     x(kk, nn, tt, j) =L= (1 - md(kk, nn, tt, j)) * X_MAX(j);
127
128 eMaintMin(kk, nn, tt, j)..
129 *     x(kk, nn, tt, j) =G= (1 - md(kk, nn, tt, j)) * X_MIN(j);
130
131 eMaintPeriod(kk, nn, tt, j)..
132 *     md(kk, nn, tt, j)
133 *     =E= sum(ttt$(ORD(ttt) <= ORD(tt)) AND (ORD(ttt) > (ORD(tt) - MDURATION))),
134 *     mb(kk, nn, ttt, j));
135
136 * eTotalFH(kk, nn, j)..
137 *     fh_uc(kk, nn, j) =E= sum(tt, u(kk, nn, tt, j));
138 *
139 * eTotalS(kk, nn, j)..
140 *     s_uc(kk, nn, j) =E= sum(tt, y(kk, nn, tt, j));
141 *
142 * eMaintCost(kk, nn, j)..
143 *     s_uc(kk, nn, j) * C_6 * (FL_A - FL_B)
144 *     - fh_uc(kk, nn, j) * C_6 * (SL_A - SL_B)
145 *     + moc_uc(kk, nn, j) * (SL_A * FL_B - SL_B * FL_A)
146 *     =G= 0;
147
148 commit(kk, nn, tt, i)..
149 *     u(kk, nn, tt, i) =E= u(kk, nn, tt-1, i) + y(kk, nn, tt, i) - z(kk, nn, tt, i);
150
151 commitB(kk, nn, tt, i)..
152 *     y(kk, nn, tt, i) =L= 1;
153
154 commitC(kk, nn, tt, i)..
155 *     z(kk, nn, tt, i) =L= 1;
156
157 eMaxUpRamp(kk, nn, tt, i)..
158 *     w(kk, nn, tt, i) - w(kk, nn, tt-1, i) =L= R(i);
159
160 eMaxDownRamp(kk, nn, tt, i)..
161 *     w(kk, nn, tt-1, i) - w(kk, nn, tt, i) =L= R(i);
162
163 eMinUpTime(kk, nn, tt, i)..
164 *     u(kk, nn, tt, i)
165 *     =G= sum(ttt$(ORD(ttt) > ORD(tt) - RR(i) and
166 *     ORD(ttt) <= ORD(tt)), y(kk, nn, ttt, i));
167
168 eMinDownTime(kk, nn, tt, i)..
169 *     1 - u(kk, nn, tt, i)
170 *     =G= sum(ttt$(ORD(ttt) > ORD(tt) - RR(i) and
171 *     ORD(ttt) <= ORD(tt)), z(kk, nn, ttt, i));
172
173 dailyGasUsage(kk, nn, dd, g)..
174 *     f(kk, nn, dd, g)
175 *     =E= sum(tt, j, x(kk, nn, tt, j)$hourToday(tt, dd) AND FIRM(j, g)) * H(j));
176
177 dailyTransportation(kk, nn, dd, g)..
178 *     fx_ST(kk, nn, dd, g) =G= f(kk, nn, dd, g) - fx_LT(g);
179
180 pipeline(kk, nn, dd)..
181 *     sum(g, fx_ST(kk, nn, dd, g)) =L= PC - GD(nn, dd);
182
183 startsLimit(kk, nn, tt, j)..
184 *     sum(ttt$(ORD(ttt) < ORD(tt)), y(kk, nn, ttt, j) - mS(kk, nn, ttt, j))
185 *     =L= mc(j) * SL_A + (1 - mc(j)) * SL_B;
186
187 startsAcc(kk, nn, tt, j)..
188 *     sum(ttt$(ORD(ttt) < ORD(tt)), y(kk, nn, ttt, j) - mS(kk, nn, ttt, j))
189 *     =G= 0;
190
191 hoursLimit(kk, nn, tt, j)..
192 *     sum(ttt$(ORD(ttt) < ORD(tt)), u(kk, nn, ttt, j) - mF(kk, nn, ttt, j))
193 *     =L= mc(j) * FL_A + (1 - mc(j)) * FL_B;
194
195 hoursAcc(kk, nn, tt, j)..
196 *     sum(ttt$(ORD(ttt) < ORD(tt)), u(kk, nn, ttt, j) - mF(kk, nn, ttt, j))
197 *     =G= 0;
198
199 maintStart(kk, nn, tt, j)..
200 *     BIG_M * mb(kk, nn, tt, j) =G= mS(kk, nn, tt, j);
201
202 maintHours(kk, nn, tt, j)..
203 *     BIG_M * mb(kk, nn, tt, j) =G= mF(kk, nn, tt, j);
204
205
206 * model solve parameters
207 MODEL dispatch / all /;
208 dispatch.optfile = 0;
209 dispatch.threads = -1;
210 sonecho > cplex.opt
211 soffecho
212
213 * model execution
214 SOLVE dispatch USING MIP MINIMIZING totalCost;

```

```

215
216 * display maintenance results
217 DISPLAY mb.l
218
219 * write out results
220 PARAMETER naturalGasUsage(nn);
221 naturalGasUsage(nn) = sum(kk, P_K(kk) * sum((tt, j), x.l(kk, nn, tt, j) * H(j)));
222
223 FILE output / hourlyResults.csv /
224
225 put output;
226 output.pw = 100000;
227
228 put "E[totalCost]";
229 put /;
230 put totalCost.l;
231 put //;
232
233 put "Fuel usage";
234 put /;
235 loop(nn,
236     put nn.tl,
237     put ", ";
238     put naturalGasUsage(nn);
239     put /;
240 );
241 put //;
242
243 put "Long-term Fuel Commitment";
244 put /;
245 loop(g,
246     put g.tl,
247     put ", ";
248     put fx_LT.l(g);
249     put /;
250 );
251 put //;
252
253
254 put "Commitment";
255 put /;
256 loop(kk,
257     loop(nn,
258         loop(j,
259             put kk.tl;
260             put ", ";
261             put nn.tl;
262             put ", ";
263             put j.tl;
264             put ", ";
265             loop(tt,
266                 put u.l(kk, nn, tt, j);
267                 put ", ";
268             );
269             put /;
270         );
271     );
272 );
273 put //;
274
275
276 put "Maintenance";
277 put /;
278 loop(kk,
279     loop(nn,
280         loop(j,
281             put kk.tl;
282             put ", ";
283             put nn.tl;
284             put ", ";
285             put j.tl;
286             put ", ";
287             loop(tt,
288                 put mb.l(kk, nn, tt, j);
289                 put ", ";
290             );
291             put /;
292         );
293     );
294 );
295 put //;
296
297
298 put "Firing hours offset";
299 put /;
300 loop(kk,
301     loop(nn,
302         loop(j,
303             put kk.tl;
304             put ", ";
305             put nn.tl;
306             put ", ";
307             put j.tl;
308             put ", ";
309             loop(tt,
310                 put mF.l(kk, nn, tt, j);
311                 put ", ";
312             );
313             put /;
314         );
315     );
316 );
317 put //;
318
319 put "Starts offset";
320 put /;
321

```

```

322 loop(kk,
323     loop(nn,
324         loop(j,
325             put kk.tl;
326             put ", ";
327             put nn.tl;
328             put ", ";
329             put j.tl;
330             put ", ";
331             loop(tt,
332                 put mS.l(kk, nn, tt, j);
333                 put ", ";
334             );
335             put "/ ";
336         );
337     );
338 put //;
339
340
341 putclose output;

```

```

1 % demandConversion.m
2 %
3 % inputs:
4 % mDemandInput: a [N:2] matrix; column 1 represents electricity demand
5 %               column 2 represents wind generation
6 % nNumClusters: desired number of clusters
7 %
8 % outputs:
9 % mDemandStates: a [days x vNumClusters] matrix that describes the number
10 %                of hours that the system spends in each state for every day
11 % mState: the mean [demand, wind] pair for each cluster
12
13
14 % test inputs for debugging
15 % X = [(1:48)' ones(48, 1) ones(48, 1)];
16 % nNumClusters = 4;
17 % vDaysInPeriod = [1 1];
18
19 function [mStateTransitions, mStateDurations, mStateValues] = ...
20     demandConversion(mDemandInput, nNumClusters, nScenario, nDaysPerPeriod, nWindScenario)
21
22     nNumElementsInDay = 24;
23
24     % for a weekly break down
25     if (nDaysPerPeriod == 7)
26         vDaysInPeriod = ones(1, 209) * 7;
27         vDaysInPeriod(end) = 5;
28
29     % for a monthly break down
30     else
31         vDaysInPeriod = [31 28 31 30 31 30 31 31 30 31 30 31 ...
32                         31 28 31 30 31 30 31 31 30 31 30 31 ...
33                         31 29 31 30 31 30 31 31 30 31 30 31 ...
34                         31 28 31 30 31 30 31 31 30 31 30 31];
35     end
36
37     vPeriodIndices = [0 cumsum(vDaysInPeriod)];
38     nNumPeriods = length(vPeriodIndices)-1;
39
40     % The demand + wind scenario input matrix is size n-by-m
41     % there are n hours of demand, and m-1 total wind scenarios.
42     nNumDays = size(mDemandInput, 1) / nNumElementsInDay;
43     nNumScenarios = size(mDemandInput, 2) - 1;
44
45     % reshape demand for clustering function, "kmeans"
46     mDemand = repmat(mDemandInput(:, 1), nNumScenarios, 1);
47     nNumRowsForAllScenarios = nNumDays * nNumElementsInDay * nNumScenarios;
48     mDemand = [mDemand reshape(mDemandInput(:, 2:end), nNumRowsForAllScenarios, 1)];
49
50     % determine kmeans clustering
51     [vDemandStates, mStateValues] = kmeans(mDemand, nNumClusters, 'Options', statset('MaxIter', 1000000));
52
53     % aggregate state durations for each day and scenario
54     % mDemandStates is a 24x(nNumDays * nNumScenarios) matrix
55     % mDemandStates is a 24x(365 * nNumScenarios) matrix
56     % [day_1_scenario_1 ... day_365_scenario_1 day_1_scenario_2 ... day_365_scenario_k]
57     mDemandStates = reshape(vDemandStates, nNumElementsInDay, nNumDays * nNumScenarios);
58
59     nNumHours = sum(vDaysInPeriod) * nNumElementsInDay;
60
61     vScenariosList = ones(nNumHours, 1) * nScenario;
62     vWindList = ones(nNumHours, 1) * nWindScenario;
63     vDaysPerPeriod = ones(nNumHours, 1) * nDaysPerPeriod;
64
65     vHoursList = repmat((1:nNumHours)', nNumScenarios, 1);
66
67     sFilename = sprintf('demandStateMapping_%i.csv', nNumClusters);
68     csvwrite(sFilename, [vDaysPerPeriod vHoursList vDemandStates vScenariosList vWindList]);
69
70     mStateDurations = hist(mDemandStates, 1:nNumClusters);
71
72     mStateTransitions = cell(nNumScenarios, nNumPeriods);
73
74     for nScenarioIndex = 1:nNumScenarios
75         for nPeriodIndex = 1:nNumPeriods
76
77             mStateTransitions{nScenarioIndex, nPeriodIndex} = ...
78                 zeros(nNumClusters, nNumClusters);
79
80             mPeriodOfInterest = ...
81                 mDemandStates(:, (vPeriodIndices(nPeriodIndex)+1):vPeriodIndices(nPeriodIndex+1));
82
83             % one more reshape to make it easier to find transitions between
84             % the previous day's hour 24 and the next day's hour 1
85             vPeriodOfInterest = reshape(mPeriodOfInterest, numel(mPeriodOfInterest), 1);
86
87             for nCurrentState = 1:nNumClusters
88
89                 vTransitionIndices = ...
90                     (diff(vPeriodOfInterest) ~= 0) ...
91                     .* (vPeriodOfInterest(1:end-1) == nCurrentState);
92
93                 vTransitions = ...
94                     vPeriodOfInterest(find(vTransitionIndices ~= 0) + 1);
95
96                 for nNextState = 1:nNumClusters
97
98                     mStateTransitions{nScenarioIndex, nPeriodIndex}(nCurrentState, nNextState) = ...
99                         sum(vTransitions == nNextState);
100
101                 end
102
103             end
104
105         end
106
107     % write out the electricity demand and wind generation means for each

```

```

108 % state/cluster
109 vScenariosList = ones(nNumClusters, 1) * nScenario;
110 vWindScenariosList = ones(nNumClusters, 1) * nWindScenario;
111 vDaysPerPeriod = ones(nNumClusters, 1) * nDaysPerPeriod;
112
113 sFilename = sprintf('stateDemandLevels_%i.csv', nNumClusters);
114 csvwrite(sFilename, [vDaysPerPeriod (1:nNumClusters)' mStateValues vScenariosList vWindScenariosList]);
115
116 % write out the amount of time that the system spends in each state
117 % for every day and scenario: [scenario day state | duration]
118 nNumRows = nNumScenarios * nNumDays * nNumClusters;
119 mStateDurationsGAMS = zeros(nNumRows, 6);
120
121 mStateDurationsGAMS(:, 1) = ones(nNumRows, 1) * nDaysPerPeriod;
122
123 vDays = zeros(nNumClusters * nNumDays, 1);
124
125 for nNumDaysIndex = 1:nNumDays
126
127     nStartIndex = (nNumDaysIndex - 1) * nNumClusters + 1;
128     nEndIndex = nStartIndex + nNumClusters - 1;
129     vDays(nStartIndex:nEndIndex) = ones(nNumClusters, 1) * nNumDaysIndex;
130
131 end
132
133 mStateDurationsGAMS(:, 2) = repmat(vDays, nNumScenarios, 1);
134
135 mStateDurationsGAMS(:, 3) = ...
136     repmat((1:nNumClusters)', nNumScenarios * nNumDays, 1);
137
138 mStateDurationsGAMS(:, 4) = reshape(mStateDurations, numel(mStateDurations), 1);
139
140 mStateDurationsGAMS(:, 5) = ones(nNumRows, 1) * nScenario;
141
142 mStateDurationsGAMS(:, 6) = ones(nNumRows, 1) * nWindScenario;
143
144 sFilename = sprintf('stateDurationsDaily_%i.csv', nNumClusters);
145 csvwrite(sFilename, mStateDurationsGAMS);
146
147
148 % write out the amount of time that the system spends in each state
149 % for every day and scenario: [scenario period state | duration]
150 nNumRows = nNumScenarios * nNumPeriods * nNumClusters;
151
152 mStateDurationsMonthlyGAMS = zeros(nNumRows, 6);
153
154 mStateDurationsMonthlyGAMS(:, 1) = ones(nNumRows, 1) * nDaysPerPeriod;
155
156 vPeriods = zeros(nNumClusters * nNumPeriods, 1);
157 for nNumPeriodsIndex = 1:nNumPeriods
158
159     nStartIndex = (nNumPeriodsIndex - 1) * nNumClusters + 1;
160     nEndIndex = nStartIndex + nNumClusters - 1;
161     vPeriods(nStartIndex:nEndIndex) = ones(nNumClusters, 1) * nNumPeriodsIndex;
162
163 end
164
165 mStateDurationsMonthlyGAMS(:, 2) = repmat(vPeriods, nNumScenarios, 1);
166
167 mStateDurationsMonthlyGAMS(:, 3) = ...
168     repmat((1:nNumClusters)', nNumScenarios * nNumPeriods, 1);
169
170 for nScenarioIndex = 1:nNumScenarios
171
172     for nPeriodIndex = 1:nNumPeriods
173
174         for nCurrentState = 1:nNumClusters
175
176             nRowIndex = nCurrentState ...
177                 + (nPeriodIndex-1) * nNumClusters ...
178                 + (nScenarioIndex-1) * nNumPeriods * nNumClusters;
179
180             % create a mask to select the right entries
181             vStateDurationIndices = ...
182                 (mStateDurationsGAMS(:, 2) > vPeriodIndices(nPeriodIndex)) ...
183                 .* (mStateDurationsGAMS(:, 2) <= vPeriodIndices(nPeriodIndex+1)) ...
184                 .* (mStateDurationsGAMS(:, 3) == nCurrentState);
185
186             mStateDurationsMonthlyGAMS(nRowIndex, 4) = ...
187                 sum(mStateDurationsGAMS(vStateDurationIndices == 1, 4));
188
189         end
190
191     end
192
193 end
194
195 mStateDurationsMonthlyGAMS(:, 5) = ones(nNumRows, 1) * nScenario;
196 mStateDurationsMonthlyGAMS(:, 6) = ones(nNumRows, 1) * nWindScenario;
197
198 sFilename = sprintf('stateDurationsMonthly_%i.csv', nNumClusters);
199 csvwrite(sFilename, mStateDurationsMonthlyGAMS);
200
201 % write out the transition tables for every scenario and period
202 % [scenario period previousState nextState | transitions]
203 nNumRows = nNumScenarios * nNumPeriods * nNumClusters * nNumClusters;
204
205 mStateTransitionsGAMS = ...
206     zeros(nNumScenarios * nNumPeriods * nNumClusters * nNumClusters, 7);
207
208 mStateTransitionsGAMS(:, 1) = ones(nNumRows, 1) * nDaysPerPeriod;
209
210 vPeriods = zeros(nNumPeriods * nNumClusters * nNumClusters, 1);
211 for nPeriodIndex = 1:nNumPeriods
212
213     nStartIndex = (nPeriodIndex - 1) * nNumClusters * nNumClusters + 1;
214     nEndIndex = nStartIndex + nNumClusters * nNumClusters - 1;

```

```

215     vPeriods(nStartIndex:nEndIndex) = ...
216         ones(nNumClusters * nNumClusters, 1) * nPeriodIndex;
217
218     end
219
220     mStateTransitionsGAMS(:, 2) = repmat(vPeriods, nNumScenarios, 1);
221
222     vPreviousStates = zeros(nNumClusters * nNumClusters, 1);
223     for nClustersIndex = 1:nNumClusters
224
225         nStartIndex = (nClustersIndex - 1) * nNumClusters + 1;
226         nEndIndex = nStartIndex + nNumClusters - 1;
227         vPreviousStates(nStartIndex:nEndIndex) = nClustersIndex;
228
229     end
230
231     mStateTransitionsGAMS(:, 3) = ...
232         repmat(vPreviousStates, nNumScenarios * nNumPeriods, 1);
233
234     mStateTransitionsGAMS(:, 4) = ...
235         repmat((1:nNumClusters)', nNumScenarios * nNumPeriods * nNumClusters, 1);
236
237     for nScenarioIndex = 1:nNumScenarios
238
239         for nPeriodIndex = 1:nNumPeriods
240
241             nStartIndex = (nScenarioIndex - 1) ...
242                 * (nNumPeriods * nNumClusters * nNumClusters) ...
243                 + (nPeriodIndex - 1) * (nNumClusters ^ 2) + 1;
244             nEndIndex = nStartIndex + (nNumClusters * nNumClusters) - 1;
245
246             mStateTransitionsGAMS(nStartIndex:nEndIndex, 5) = reshape(...
247                 mStateTransitions{nScenarioIndex, nPeriodIndex}', ...
248                 1, nNumClusters * nNumClusters)';
249
250         end
251
252     end
253
254     mStateTransitionsGAMS(:, 6) = ones(nNumRows, 1) * nScenario;
255     mStateTransitionsGAMS(:, 7) = ones(nNumRows, 1) * nWindScenario;
256
257     sFilename = sprintf('stateTransitionsMonthly_%i.csv', nNumClusters);
258     csvwrite(sFilename, mStateTransitionsGAMS);
259
260 end

```

# Bibliography

- [Aouam et al., 2010] Aouam, T., Rardin, R., and Abrache, J. (2010). Robust strategies for natural gas procurement. *European Journal of Operational Research*, 205(1):151–158.
- [Ausubel and Ashcroft, 2007] Ausubel, L. and Ashcroft, P. (2007). The ISO-NE FCA Auction Method and Process.
- [Avery et al., 1992] Avery, W., Brown, G. G., Rosenkranz, J. A., and Wood, R. K. (1992). Optimization of Purchase, Storage and Transmission Contracts for Natural Gas Utilities. *Operations Research*, 40(3):446–462.
- [Baleriaux et al., 1967] Baleriaux, H., Jamouille, E., and de Guertechin, F. L. (1967). Simulation de l’exploitation d’un parc de machines thermiques de production d’électricité couplée à des stations de pompage. *Société Royale Belge des Electriciens*, 7:225–245.
- [Barquín, 2012] Barquín, J. (2012). *Chapter 13. Electricity and gas*.
- [Boiteux, 1960] Boiteux, M. (1960). Peak-Load Pricing. *The Journal of Business*, 33(2):157–179.
- [Booth, 1972] Booth, R. R. (1972). Power System Simulation Model Based On Probability Analysis. *IEEE Transactions on Power Apparatus and Systems*, pages 62–69.
- [Boyce, 2012] Boyce, M. P. (2012). *Gas Turbine Engineering Handbook*. Elsevier, Oxford, fourth edition.
- [Butler and Dyer, 1999] Butler, J. C. and Dyer, J. S. (1999). Optimizing Natural Gas Flows with Linear Programming and Scenarios. *Decision Sciences*, 30(2):563–580.
- [Caramanis, 1982] Caramanis, M. (1982). Investment Decisions and Long-Term Planning Under Electricity Spot Pricing. *IEEE Transactions on Power Apparatus and Systems*, 75(12):4640–4648.
- [Caramanis et al., 1982] Caramanis, M., Bohn, R., and Schweppe, F. (1982). Optimal Spot Pricing: Practice and Theory. *IEEE Transactions on Power Apparatus and Systems*, 75(9):3234–3245.

- [Chen and Baldick, 2007] Chen, H. and Baldick, R. (2007). Optimizing Short-Term Natural Gas Supply Portfolio for Electric Utility Companies. *IEEE Transactions on Power Systems*, 22(1):232–239.
- [Cohen and Wan, 1987] Cohen, A. and Wan, S. H. (1987). A Method For Solving the Fuel Constrained Unit Commitment Problem. *IEEE Transactions on Power Systems*, 2(3):608–614.
- [Conejo, 1992] Conejo, A. (1992). *Equivalent Load Production Cost Models for Thermal Dominated Electric Energy Systems*. PhD thesis, Universidad Pontificia Comillas.
- [Dueñas et al., 2012] Dueñas, P., Barquín, J., and Reneses, J. (2012). Strategic Management of Multi-Year Natural Gas Contracts in Electricity Markets. *IEEE Transactions on Power Systems*, 27(2):771–779.
- [Dueñas et al., 2014] Dueñas, P., Leung, T., Gil, M., and Reneses, J. (2014). Gas-Electricity Coordination in Competitive Markets under Renewable Energy Uncertainty. *IEEE Transactions on Power Systems*.
- [Dueñas et al., 2011] Dueñas, P., Reneses, J., and Barquín, J. (2011). A Medium-Term Operation Model for a Natural Gas System. In *International Conference on the European Energy Market*, number May, pages 327–332.
- [Economist, 2013] Economist (2013). How to lose half a trillion euros: Europe’s electricity providers face an existential threat. *The Economist*, pages 1–12.
- [Economist, 2014] Economist (2014). Nuclear power in Japan: Start ’em up. *The Economist*, pages 1–5.
- [EIA, 2013] EIA (2013). Natural Gas Consumption by End Use.
- [Eléctrica, 2014] Eléctrica, R. (2014). Red Eléctrica publishes the ’Spanish Electricity System Report 2013’.
- [Fancher et al., 1986] Fancher, R. B., Wilson, J. F., and Mueller, H. A. (1986). Fuel Contracting Under Uncertainty. *IEEE Transactions on Power Systems*, 1(1):26–32.
- [FERC, 2012] FERC (2012). Staff Report on Gas-Electric Coordination Technical Conferences (Docket No . AD12-12-000). Technical report.
- [FERC, 2014] FERC (2014). Gas-Electric Coordination Quarterly Report to the Commission Gas-Electric Coordination Quarterly Update. Technical report.
- [Finger, 1975] Finger, S. (1975). Modeling Conventional and Pumped Hydro-Electric Energy Using Booth-Baleriaux Probabilistic Simulation.
- [Grossman et al., 2000] Grossman, T. A., Rohleder, T. R., and Silver, E. A. (2000). A negotiation aid for fixed-quantity contracts with stochastic demand and production. *International Journal of Production Economics*, 66.



- [Guldmann, 1983] Guldmann, J.-M. (1983). Supply, Storage, and Service Reliability Decisions by Gas Distribution Utilities: A Chance-Constrained Approach. *Management Science*, 29(8):884–906.
- [Guldmann and Wang, 1999] Guldmann, J.-M. and Wang, F. (1999). Optimizing the natural gas supply mix of local distribution utilities. *European Journal of Operational Research*, 112(3):598–612.
- [Hanak, 2014] Hanak, E. (2014). Allow Water Rights Trading for Farmers.
- [Hanak and Stryjewski, 2012] Hanak, E. and Stryjewski, E. (2012). Californias Water Market, By the Numbers: Update 2012. (November):1–48.
- [Howitt and Hansen, 2005] Howitt, R. and Hansen, K. (2005). The Evolving Western Water Markets. *Choices: The Magazine of Food, Farm, and Resource Issues*.
- [Hunt et al., 2014] Hunt, H., Dolan, D., and Rudiak, J. (2014). New England Gas-Electric Focus Group Final Report. Technical report, New England Gas-Electric Focus Group.
- [ISO-New England, 2013a] ISO-New England (2013a). 2013 Regional System Plan. Technical report, ISO New England.
- [ISO-New England, 2013b] ISO-New England (2013b). Resource Mix.
- [ISO-New England, 2013c] ISO-New England (2013c). Winter 2013-14 Reliability Program. Technical report.
- [ISO-New England, 2014a] ISO-New England (2014a). Forward Capacity Market (FCA 8) Result Report. Technical Report Fca 8.
- [ISO-New England, 2014b] ISO-New England (2014b). Market Rule 1.
- [ISO-New England, 2015] ISO-New England (2015). 2014/2015 Winter Outlook: Sufficient Power Supplies Expected, but Natural Gas Pipeline Constraints an Ongoing Concern.
- [Juris, 1998] Juris, A. (1998). Development of Competitive Natural Gas Markets in the United States. Technical report, The World Bank Group.
- [Koberstein et al., 2011] Koberstein, A., Lucas, C., Wolf, C., and Konig, D. (2011). Modeling and optimizing risk in the strategic gas-purchase planning problem of local. *The Journal of Energy Markets*, 4(3):47–68.
- [LaFleur et al., 2014a] LaFleur, C. A., Moeller, P. D., Norris, J. R., and Clark, T. (2014a). Order on Tariff Filing and Instituting Section 206 Proceeding.
- [LaFleur et al., 2014b] LaFleur, C. A., Moeller, P. D., Norris, J. R., and Clark, T. (2014b). Order on Technical Conferences.

- [Lee, 1989] Lee, F. N. (1989). A Fuel-Constrained Unit Commitment Method. *IEEE Transactions on Power Systems*, 4(3):1208–1218.
- [Lee, 1991] Lee, F. N. (1991). The Coordination of Multiple Constrained Fuels. *IEEE Transactions on Power Systems*, 6(2):699–707.
- [Leung, 2012] Leung, T. (2012). *A Chronological Probabilistic Production Cost Model to Evaluate the Reliability Contribution of Limited Energy Plants by*. PhD thesis, Massachusetts Institute of Technology.
- [Maceira et al., 1996] Maceira, M., Pereira, M., and Janeiro, R. D. (1996). Analytical modeling of chronological reservoir operation in probabilistic production costing [of hydrothermal power systems]. *IEEE Transactions on Power Systems*, 11(1):171–180.
- [Makhholm, 2006] Makhholm, J. D. (2006). The Theory of Relationship-Specific Investments , Long-Term Contracts and Gas Pipeline Development in the United States 1.
- [Meeteren, 1984] Meeteren, H. P. V. (1984). Scheduling of Generation and Allocation of Fuel Using Dynamic and Linear Programming. *IEEE Transactions on Power Apparatus and Systems*, PAS-103(7):1562–1568.
- [MITEI, 2011a] MITEI (2011a). Managing Large-Scale Penetration of Intermittent Renewables. Technical report, MIT Energy Initiative, Cambridge, MA.
- [MITEI, 2011b] MITEI (2011b). The Future of Natural Gas. Technical report, Cambridge, MA.
- [MITEI, 2013] MITEI (2013). Growing Concerns, Possible Solutions: The Interdependency of Natural Gas and Electricity Systems. Technical report, MIT Energy Initiative, Cambridge, MA.
- [Morrow, 2013] Morrow, R. (2013). Forward Capacity Market Settlement Components & Timeline.
- [Mwasinghe, 1981] Mwasinghe, M. (1981). Principles of Modern Electricity Pricing. *Proceedings of the IEEE*, 69(3).
- [Nuttall, 2011] Nuttall, W. (2011). Nuclear Power and Large-Scale Renewables in Liberalized Power Markets: A British and European Perspective. In *MITEI Symposium*.
- [Padhy, 2004] Padhy, N. (2004). Unit Commitment A Bibliographical Survey. *IEEE Transactions on Power Systems*, 19(2):1196–1205.
- [Palmintier and Webster, 2012] Palmintier, B. S. and Webster, M. D. (2012). Heterogeneous Unit Clustering for Efficient Operational Flexibility Modeling Extended Working Paper.

- [Pérez-Arriaga, 2013] Pérez-Arriaga, I. J. (2013). *Regulation of the Power Sector*. Power Systems. Springer London, London.
- [Petrash, 2005] Petrash, J. M. (2005). Long-term Natural Gas Contracts: Dead, Dying, or Merely Resting? (July):545–582.
- [Rodilla, 2010] Rodilla, P. (2010). *Regulatory Tools to Enhance Security of Supply at the Generation Level*. PhD thesis, Universidad Pontificia Comillas de Madrid.
- [Rodilla et al., 2014] Rodilla, P., Cerisola, S., and Batlle, C. (2014). Modeling the Major Overhaul Cost of Gas-Fired Plants in the Unit Commitment Problem. *IEEE Transactions on Power Systems*, pages 1–11.
- [Ruff, 2012] Ruff, L. E. (2012). Rethinking Gas Markets—and Capacity. *Economics of Energy & Environmental Policy*, 1(3):1–14.
- [Schweppe, 1987] Schweppe, F. C. (1987). *Spot pricing of electricity*. Kluwer Academic, Boston.
- [Steiner, 1957] Steiner, P. (1957). Peak Loads and Efficient Pricing. *The Quarterly Journal of Economics*, 71(4):585–610.
- [Street et al., 2008] Street, A., Barroso, L., Chabar, R., Mendes, A., and Pereira, M. (2008). Pricing Flexible Natural Gas Supply Contracts Under Uncertainty in Hydrothermal Markets. *IEEE Transactions on Power Systems*, 23(3):1009–1017.
- [Sundheim, 2001] Sundheim, E. (2001). Long-Term Service Agreements: Weighing the Risks and Rewards.
- [Tabors et al., 2012] Tabors, R. D., Englander, S., and Stoddard, R. (2012). Who’s on First? The Coordination of Gas and Power Scheduling. *The Electricity Journal*, 25(5):1–8.
- [Tavernise, 2014] Tavernise, S. (2014). Drug Shortages Continue to Vex Doctors.
- [Thompson, 1995] Thompson, A. C. (1995). Valuation of Path-Dependent Contingent Claims with Multiple Exercise Decisions over Time. *The Journal of Financial and Quantitative Analysis*, 30(2):271–293.
- [Thompson and Yost, 2014] Thompson, R. and Yost, J. (2014). Long Term Service Agreements: The "Top 10" Contractual Pitfalls and How to Avoid Them.
- [Transco, 2012] Transco (2012). Contracts Overview. Technical report, Transco.
- [Troy et al., 2012] Troy, N., Flynn, D., Milligan, M., and O’Malley, M. (2012). Unit Commitment With Dynamic Cycling Costs. *IEEE Transactions on Power Systems*, 27:2196–2205.

- [Vaitheeswaran and Balasubramanian, 2010] Vaitheeswaran, N. and Balasubramanian, R. (2010). Stochastic Model for Natural Gas Portfolio Optimization of a Power Producer. In *Power Electronics, Drives and Energy Systems*.
- [Vaitheeswaran and Balasubramanian, 2012] Vaitheeswaran, N. and Balasubramanian, R. (2012). Fuel Management Strategy of Combined Cycle Power Plant under Uncertainty. In *Power, Signals, Control, and Computation*.
- [Varian, 2010] Varian, H. (2010). *Intermediate Microeconomics*. W. W. Norton & Company, New York, eighth edition.
- [Vázquez et al., 2002] Vázquez, C., Rivier, M., and Pérez-Arriaga, I. J. (2002). A Market Approach to Long-Term Security of Supply. *IEEE Transactions on Power Systems*, 17(2):349–357.
- [Vazquez et al., 2012] Vazquez, M., Hallack, M., and Glachant, J.-m. (2012). Designing the European Gas Market: More Liquid & Less Natural? *Economics of Energy & Environmental Policy*, 1(3):25–38.
- [Vemuri and Lemonidis, 1992] Vemuri, S. and Lemonidis, L. (1992). Fuel Constrained Unit Commitment. *IEEE Transactions on Power Systems*, 7(1):410–415.
- [Wogrin et al., 2012] Wogrin, S., Barquín, J., Member, S., and Centeno, E. (2012). Capacity Expansion Equilibria in Liberalized Electricity Markets: An EPEC Approach. *IEEE Transactions on Power Systems*, pages 1–9.
- [Wogrin et al., 2013] Wogrin, S., Dueñas, P., and Delgado, A. (2013). A New Approach to Model Load Levels in Electric Power Systems with High Renewable Penetration. *IEEE Transactions on Power Systems*, pages 1–8.
- [Wong and Wong, 1996] Wong, K. P. and Wong, Y. W. (1996). Combined Genetic Algorithm/Simulated Annealing/Fuzzy Set Approach to Short-Term Generation Scheduling with Take-Or-Pay Fuel Contract. *IEEE Transactions on Power Systems*, 11(1).