













-  - Fiberglass
-  - Aluminum
-  - Steel screws
-  - Nylon screws (shear pins)
-  - Epoxied Bond
-  - RTV silicone gasket

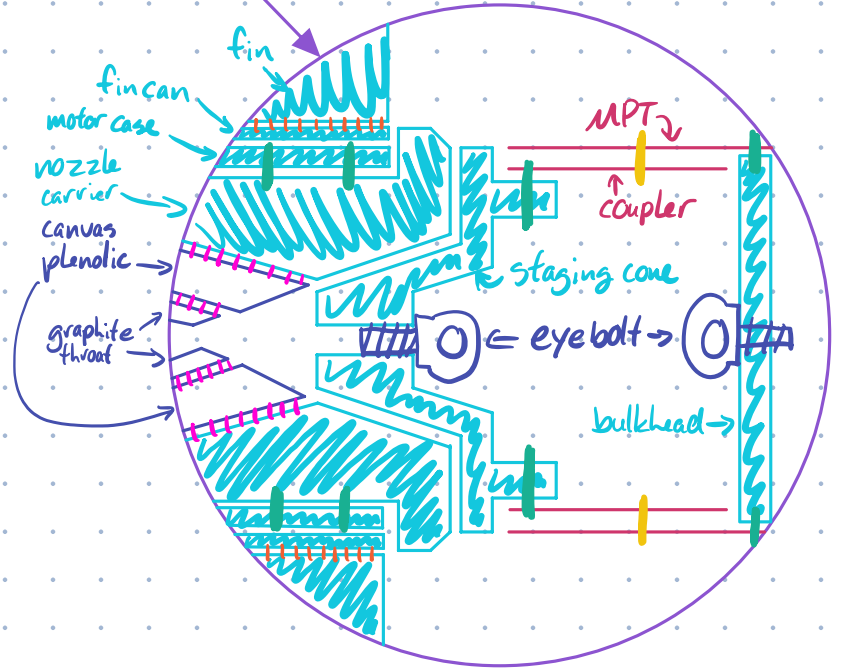
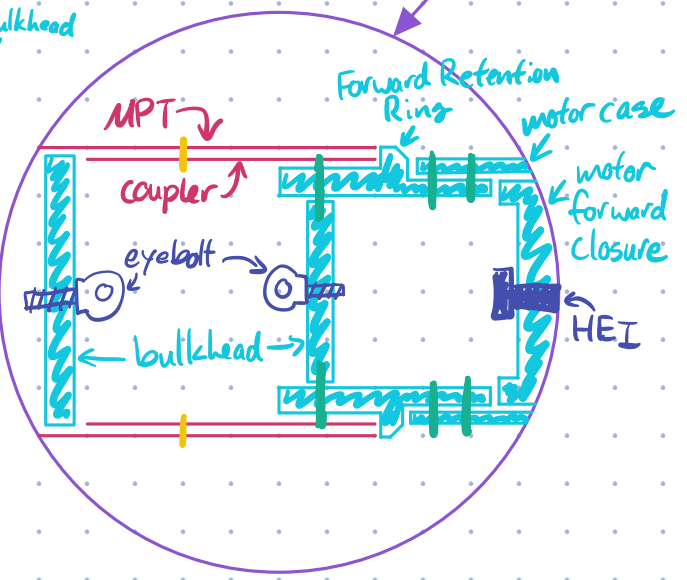
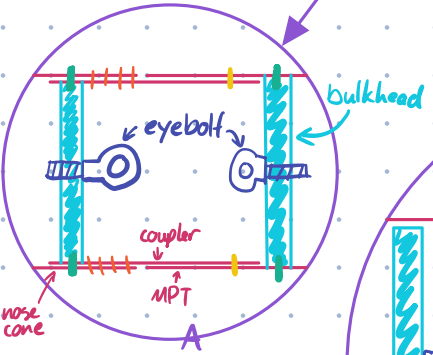
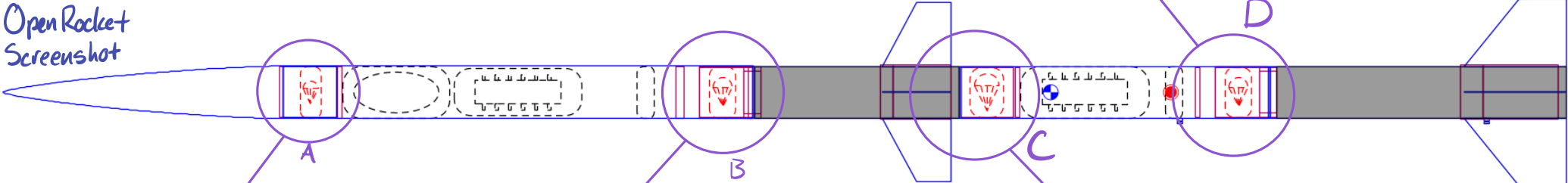
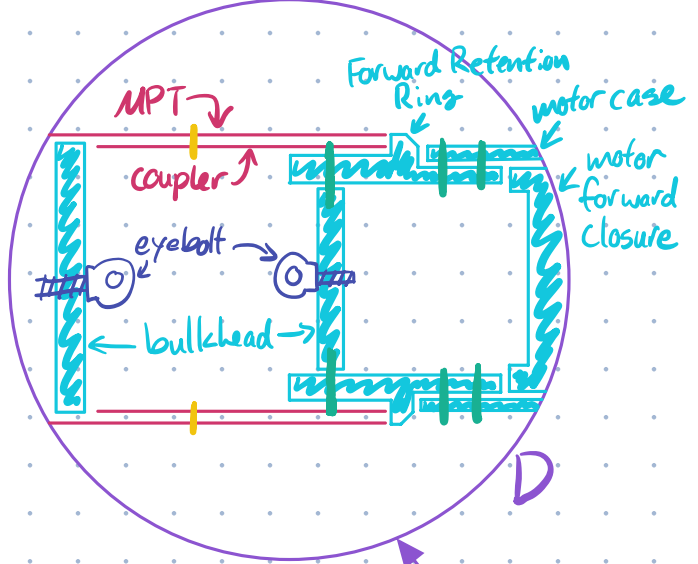
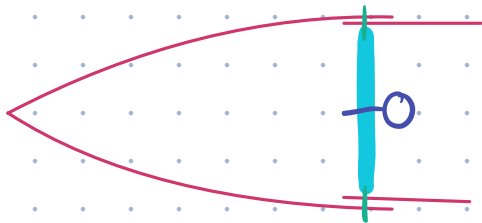

Open Rocket Screenshot

B



-  - Fiberglass
-  - Aluminum
-  - Steel screws
-  - Nylon screws (shear pins)
-  - Epoxied Bond

Sustainer

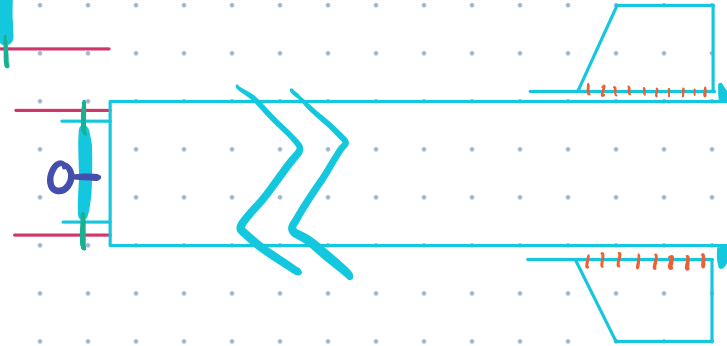
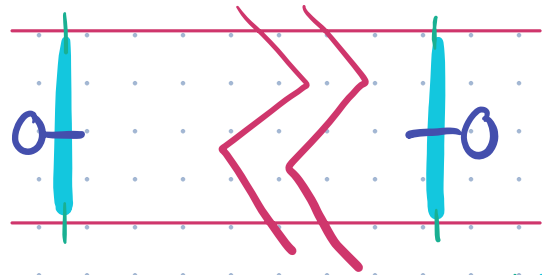

Booster

