

Defense

Introduction

In this section, we will cover some of the basic principles that are useful for new players to understand how we play team defense in volleyball.

To start, take a quick look at the court shown on the right. That will give you a frame of reference for a lot of the diagrams that follow.

There are two sections here. The first section deals with basic team defense principles and formations that are common across all playing levels. These deal with your base position (where to stand when the ball is on the opposing team's side of the court) and how to react from base position when the opposing team is sending you relatively easy balls to pass. The second section presents a series of defensive systems that we use if the opposing team gets the chance to get a good set and run an offense.

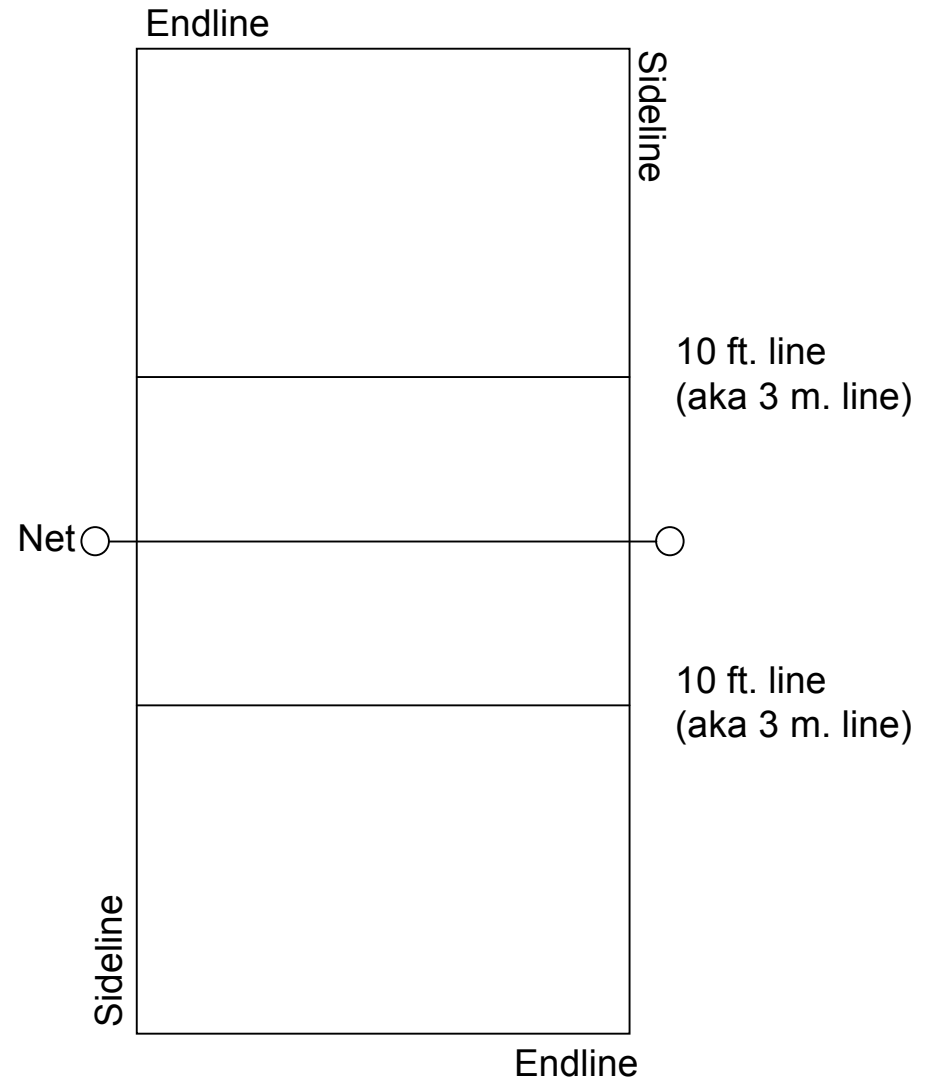

Basic Defensive Principles

Just a couple of thoughts...

A good defense works together.

Each component of the defense is trying to take away some option from the other team's offense. The block takes something. Each non-blocking defender takes something. A good defense knows every individual's responsibilities and understands how they mesh.

A good defense uses smart positioning.

Positioning deals with two aspects of defending the hitter. The average hitter at a given position (outside hitter, middle or right side) has certain tendencies. In addition, there are shots that are more difficult to defend than others because there is a shorter path (and thus less reaction time) from hitter to defender. The default positioning should position you to take away the average hitter's tendencies and it should position you to defend the more difficult shot first (since you have the least time to react to it).

A good defense makes adjustments.

Good defenses understand how the capabilities of the hitters and defenders interact and affect the way you have to play defense. For example, if your blockers aren't tall enough to block the other team's hitters, you may have to adjust where you set up on defense. Good defenses realize what kinds of shots a hitter is capable of hitting (or prefers to hit) and continues to fine tune their defense to take those shots away.

A good defense is disciplined.

Good team defenders do their job consistently. They position themselves in the right place every play. They close blocks every play. They avoid trying to do too much and conflicting with their teammates.

A good defense works hard.

In the end, a good defense outworks the other team in terms of their willingness to chase balls, dive and hustle.

Base Position

The starting point for your defense is base position. **Every time the other team has the ball, get to base position as soon as you can.**

From here, you are positioned to defend against the first contacts that the other team might send back to you: an overpass, a quick setter dump or a quick attack from the middle.

AFTER the ball is set, you react - usually transitioning to a different defensive alignment that is better suited to defend the attack.

In the descriptions that follow, we will label players by their physical position on the court. For the most part, your defensive assignment depends on where you are on the court and not your role on the team (ie the player in left front is expected to do certain things, no matter if she is a setter, a middle blocker, etc.)

LEFT FRONT

Positioning: starts at net, about 2 feet from sideline. If your assignment involves blocking the middle attack (covered later and shown in this diagram), slide closer to the middle front player (about 2 - 4 feet from her).

Responsibilities in Base Position: take overpasses to short left front; block opposing team's setter attack; communicate if the opposite moves away from you to attack in another zone along the net.

MIDDLE FRONT

Positioning: starts at net in the middle.

Responsibilities in Base Position: take overpasses to short middle front; help block opposing team's setter attack if possible (but the middle attack is the priority); communicate if the middle hitter leaves to attack in another zone along the net.

RIGHT FRONT

Positioning: starts at net, about 2 feet from sideline.

Responsibilities in Base Position: take overpasses to short right front; communicate if the outside hitter leaves to attack in another zone along the net.

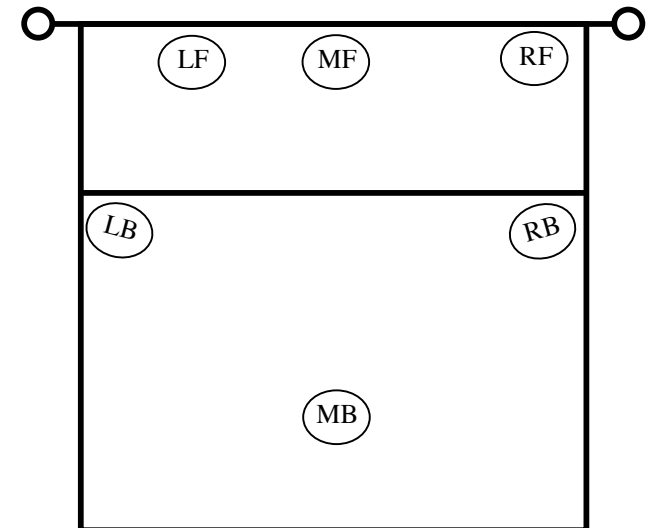

Base Position (continued)

LEFT BACK

Positioning: starts just behind the 10 ft. line. The position relative to the left sideline is determined by balancing a couple factors. You want to defend the sideline against the quick attack from the middle hitter, but still be able to cover the middle of the court if the setter tips. Generally, you want to be as close to the left sideline as you can while still being able to reach the middle of the court with one step and dive. *The most extreme version of the positioning is shown here.* You could easily shift your base position towards the middle of the court until you were 2 -3 feet from the sideline. Should be slightly turned to face into the court.

Responsibilities in Base Position: take overpasses to medium left half of court; defend the setter attack, particularly the tip and backhand flip; defend the quick attack to the sideline.

MIDDLE BACK

Positioning: starts middle of the court about 4 – 6 feet from endline.

Responsibilities in Base Position: take overpasses to anywhere deep on the court, defend setter attacks to anywhere deep on the court; defend quick attacks to the middle back area as well as possible.

RIGHT BACK

Positioning: starts just behind the 10 ft. line. The position relative to the right sideline is determined by balancing a couple factors. You want to defend the sideline against the quick attack from the middle hitter, but still be able to cover the middle of the court if the setter tips. Generally, you want to be as close to the sideline as you can while still being able to reach the middle of the court with one step and dive. *The most extreme version of the positioning is shown here.* You could easily shift your base position towards the middle of the court until you were 2 -3 feet from the sideline. Should be slightly turned to face into the court.

Responsibilities in Base Position: take overpasses to medium right half of court; defend the setter attack, particularly the lefty "throw" to the middle of the court; defend the quick attack to the sideline.

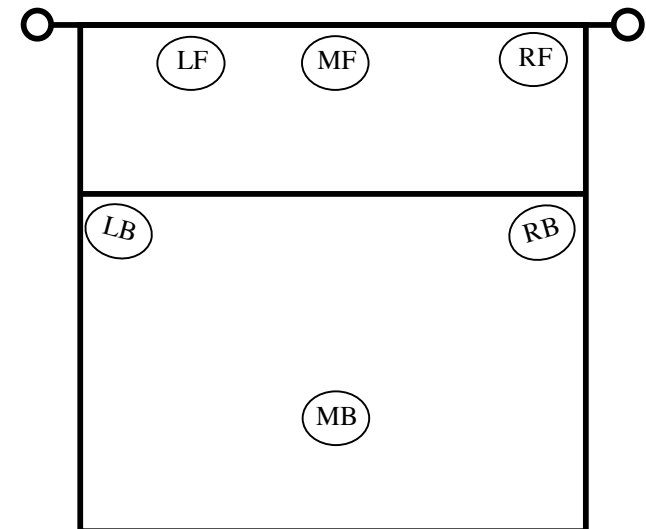

Base Position

A couple of examples of what you cover from your base position.

Areas of Responsibility for Overpasses

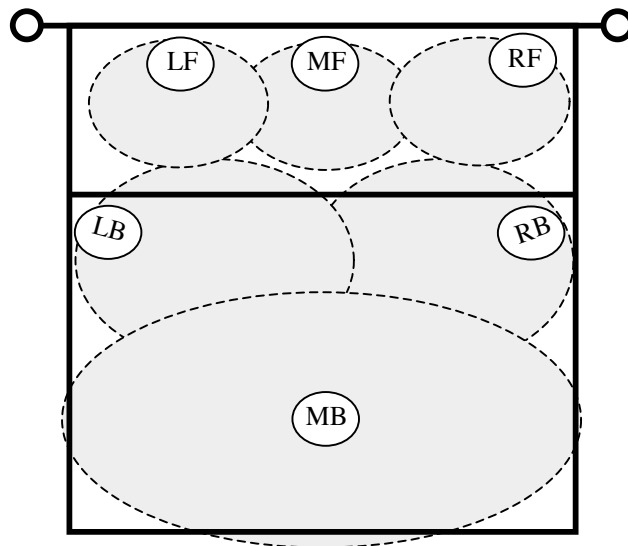

Front row players attack the overpass or play overpasses that they can reach by taking one or two steps off the net. **Back row players** divide the court as shown with middle back looking to get balls to the deep corners.

Areas of Responsibility for Setter Attacks

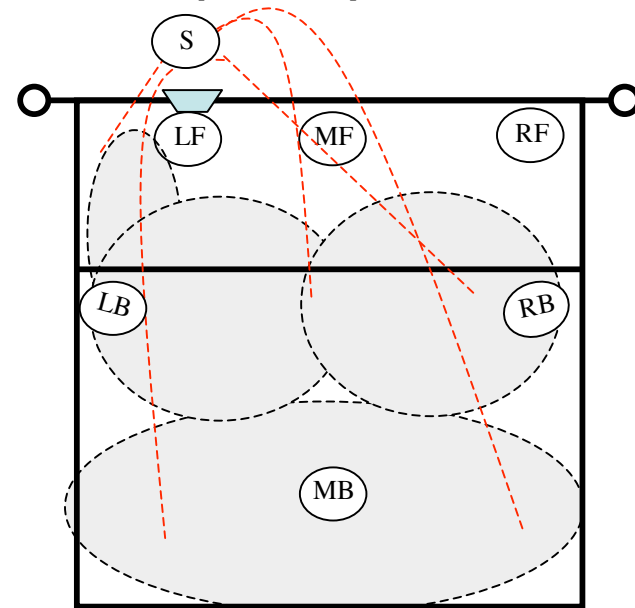

Left front blocks setter. **Left back** digs tips to left front and tips over the blocker to the middle. **Right back** digs hard throws to the right side and tips over the blocker to the middle. **Middle back** covers the back, including the deep corners. Middle front and right front help if possible, but have to prioritize blocking the other team's primary hitters.

Playing the Free Ball

After base position, the first basic defensive alignment is **Free Ball Defense**. A free ball is any ball that the other team passes over (as opposed to anything that is hit overhand). Since this ball is passed instead of hit, it's usually a lot slower and higher: you want to be sure you get a perfect pass so you can run your full offense.

The goal of this alignment is to reposition the team so the setter can release to her setting position early while the rest of the players cover the court efficiently.

Since Free Ball Defense keys on having the setter release, the setter usually calls when the team should switch to this formation. If she thinks it's a free ball, she will be releasing and the team needs to cover the region of the court she leaves. If the setter doesn't think it's a free ball, she will be playing defense and you don't want to switch to Free Ball defense because you'll have redundant positioning.

Movement (Setter front row)

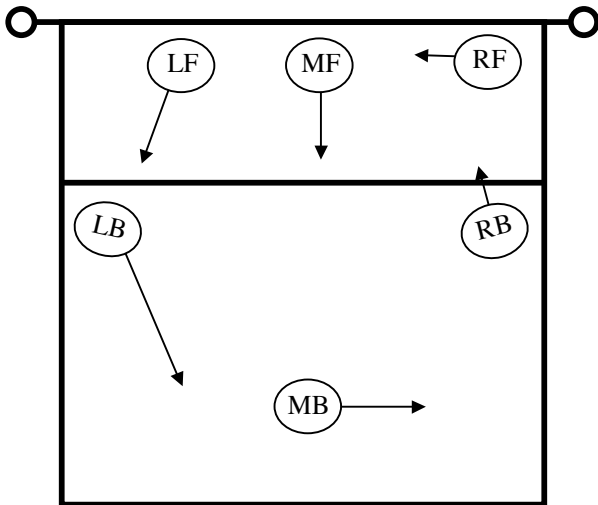

Front row drops back except for the setter (who should be in right front). The setter moves to set. Back row players rotate to cover additional regions of the court.

Free Ball Defense (Setter front row)

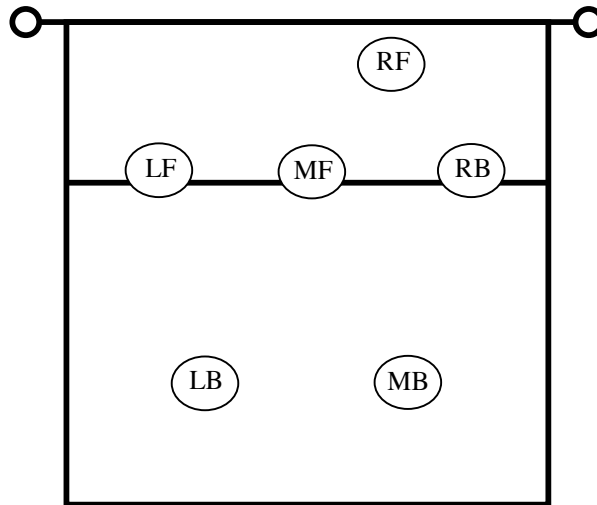

Areas of Responsibility

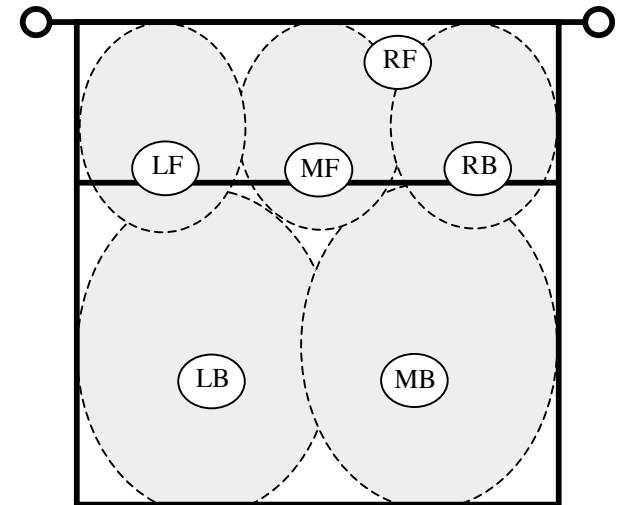

The three players across the 10-foot line take short balls. The two players in back split the back part of the court.

Playing the Free Ball

If the setter is in the back row, there is a slight variation on how you move. As shown on the previous page, if the setter is front row, she just goes straight to her position and the opposite takes short balls to the front right, often without having to move very much from her base position.

If the setter is back row, she transitions to her setting position at the net, and the opposite has to drop back from the net to take the short balls to the front right. Notice that the team ends up in the same alignment; only the setter and opposite have different movements.

Movement (Setter back row)

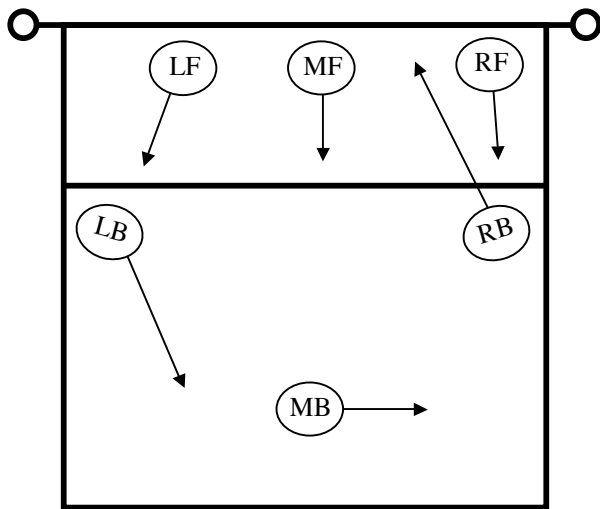

Free Ball Defense (Setter back row)

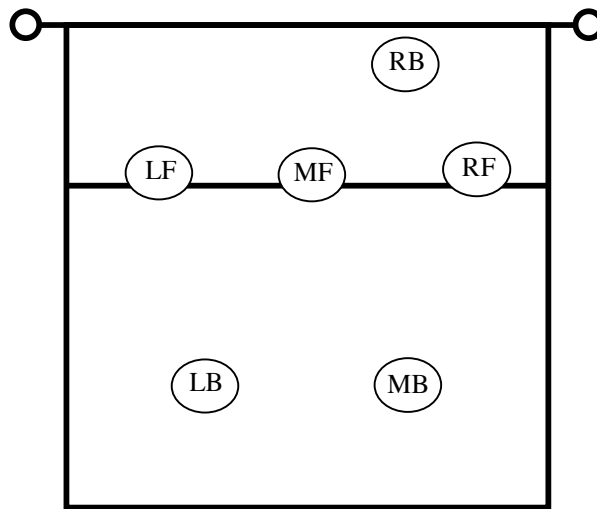

Areas of Responsibility

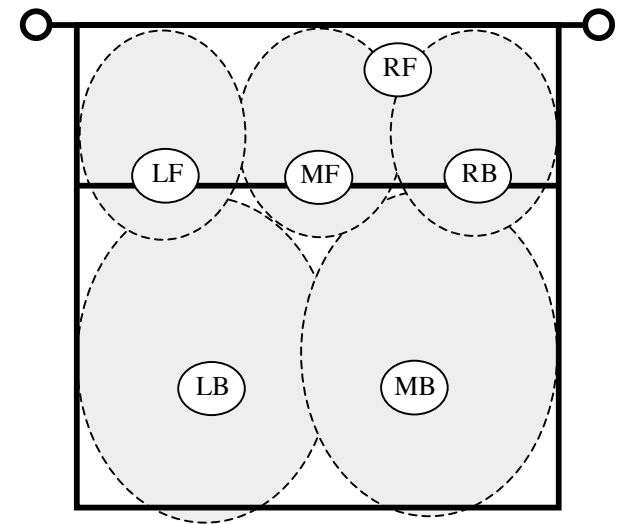

Front row drops back. Setter goes to her setting position at the net. Left back and middle back rotate over to cover additional regions of the court.

The three players across the 10-foot line take short balls. The two players in back split the back part of the court.

Playing the Down Ball

A second basic defensive alignment is **Down Ball Defense**. This alignment is typically used in two situations: the opposing team is attacking the ball aggressively (some form of overhand attack), but not jumping and spiking at the net; or the hitter is spiking from the back row. In both cases, the ball may have a lot of velocity, but it isn't necessarily going downwards as sharply as if it had been hit by a front row spike.

The general principle is the middle front blocks the hitter one-on-one while the other defenders form a "cup" oriented along the direction the hitter is facing. Middle front jumps a little later (to compensate for the fact the hitter is not leaping or is leaping from the back row). This block needs to protect the middle of the court. The other defenders need to stay deep, but ready to take a step in for an off-speed shot. There are nearly infinite variations of attacker position, so it is not possible to draw a diagram for each option. Following are some examples that should illustrate the basic principles.

Remember: **BASE POSITION** to start, transition to this alignment after the ball has been set and you realize the team is hitting, but not spiking at the net.

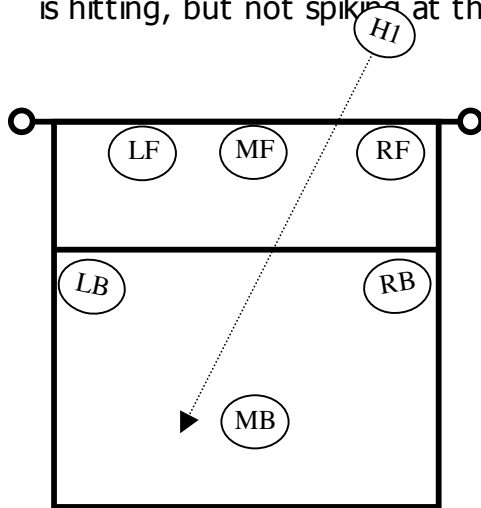

Team recognizes the hitter is going to swing while standing on the floor (or jumping from the backrow). Team recognizes the direction the hitter is facing.

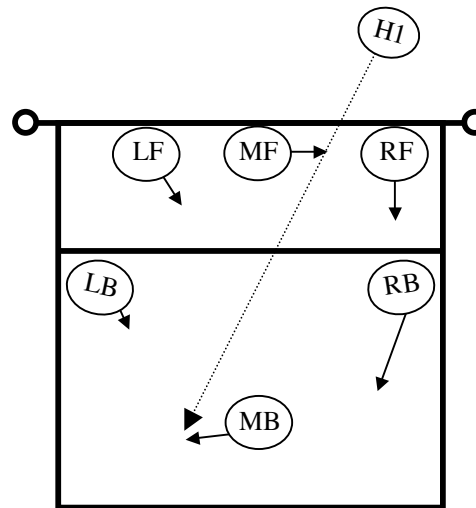

Middle front moves to block. Other front row players drop off the net. Back row players rotate to cover the ball hit in the direction the hitter is facing.

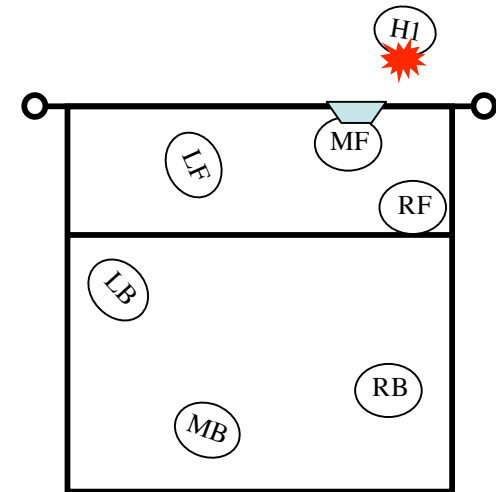

Playing the Down Ball

Down ball from middle (top row) or right side (bottom row) All cases show base position, movement and final position.

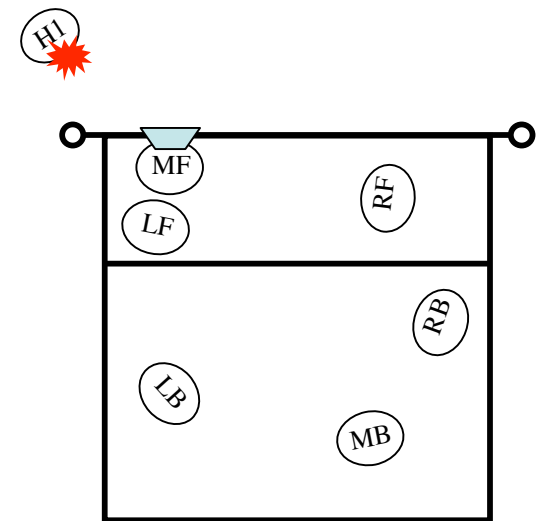
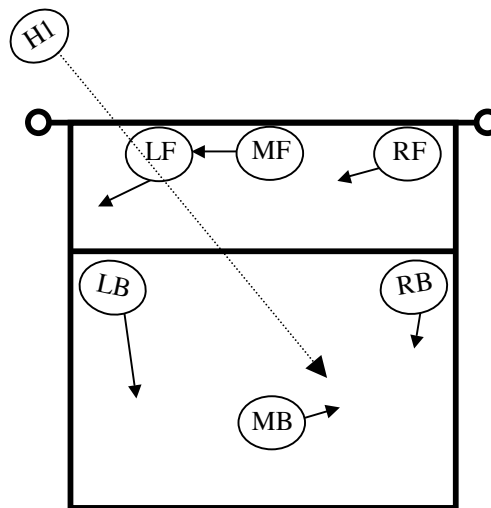
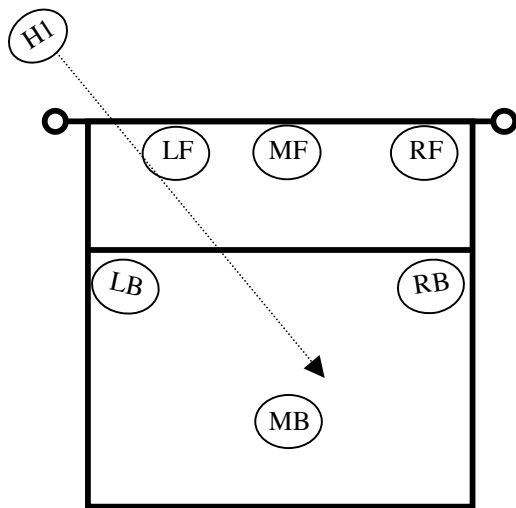
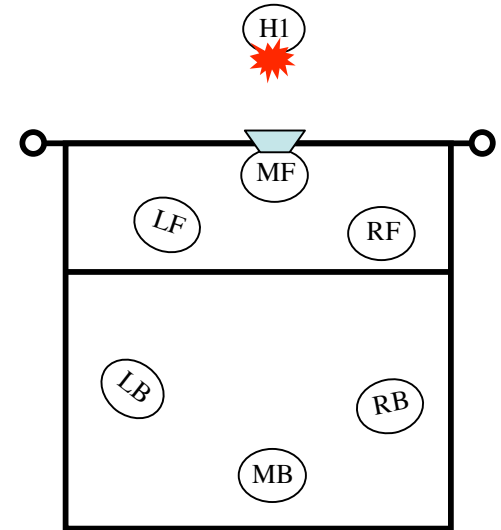
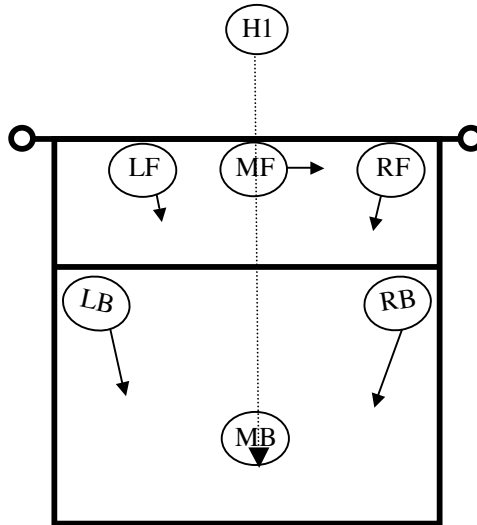
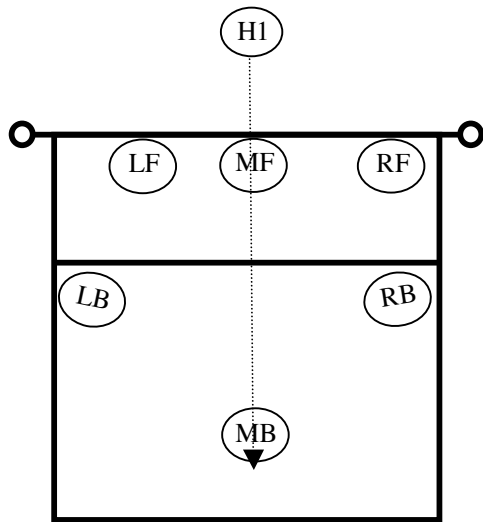

Transitioning to Defend Different Attacks

In the first section, we covered some basics that are common to every level of play: Base Position, Free Ball Defense and Down Ball Defense.

Once you've got the basics down, it's time to learn about how to adjust once a set has been made. In general, there are two common alignments we use against the middle hitter and three common alignments we use against the wing hitters (the left side hitter or the right side hitter). As each alignment offers different strengths and weaknesses, we use them with different frequencies at different playing levels, depending on which is best suited to the opponent's skill level.

Against the middle hitter, we are primarily concerned with whether we use a **single block** (our middle front) or a **double block** (middle front and left front). This decision then informs how the defenders set up behind the block.

Against the wing hitters, we always use two blockers (the middle front assists both left and right front), so the changes in defense primarily involve the arrangement of the defenders behind the block. In the **standard** defense, each player has a specific zone to defend behind the blockers. In the **tip rotation** defense, you bring one player up close to the block to cover short shots while the other players rotate over to cover the court. In the **perimeter** defense, you position players to defend specific areas near the edges of the court, areas that the hitters are forced to aim at because your block is closing off other areas of the court.

In the following sections, we'll go over the single block and the double block against two of the most common middle attacks. In addition, we'll go over the standard, tip rotation and perimeter defense against both the outside hitter and the right side hitter.

Defending the Middle: Single block

Defending the "1" (quick middle attack)

If a team is running the "1", you are more likely to be playing at a level where you should be double blocking the middle. Still, there will be times when you may want to single block on the middle. In this case, you are really depending on your base position and the ability of your wing diggers to stay disciplined in their base position, make a good read of the hitter's attack and make a good play to defend the ball.

Movement from Base

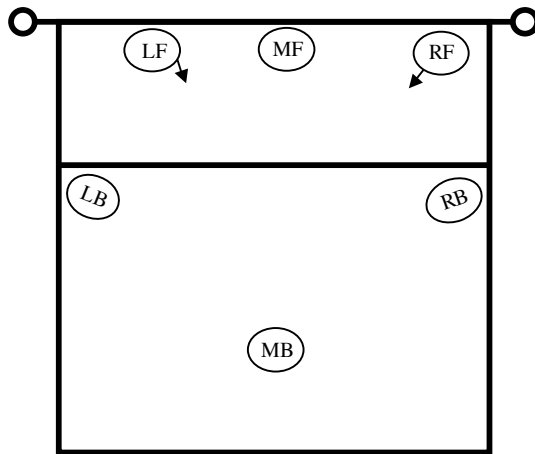

The MF is positioned to block the opposing team's middle hitter. The three backrow defenders are in base position and ready to dig. The RF turns and takes a step off the net. The LF also turns and takes a step off the net.

Defensive Position

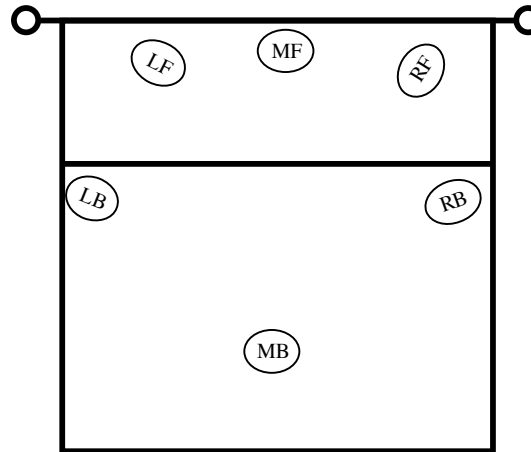

Since the attack is quick, there is usually not enough time for the front row players to drop back any appreciable distance and still be able to make a good dig. They should instead look to play deflections, sharp angle shots and tips.

Areas of Coverage

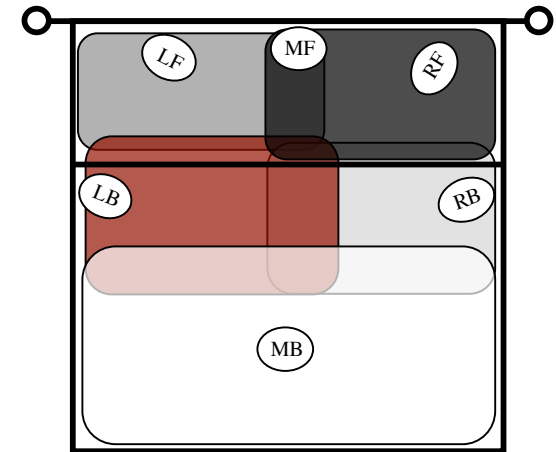

This shows the basic coverage areas for each digger. The block has primary responsibility for protecting the middle of the court and the hitter's power angle. Note that all the diggers overlap to some extent.

Defending the Middle: Single block

Defending the "1" (quick middle attack)

A closer look at defensive responsibilities for specific attacks

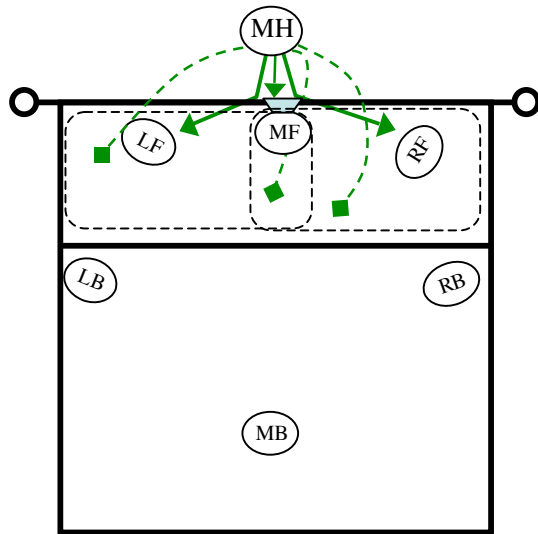

MF blocks, protecting the middle of the court. The LF looks first for tools off the block along the net. This is the shot with the least reaction time, so defend it first. The next priority is tips to her half of the court (examples are shown for both LF and RF). The RF also looks for tools off the block and then tips to her half of the court. If possible, the RF should take priority for tips towards the middle. This frees the LF to transition to hit. The set to LF is usually the easiest one, so you will often want to prioritize that shot in transition.

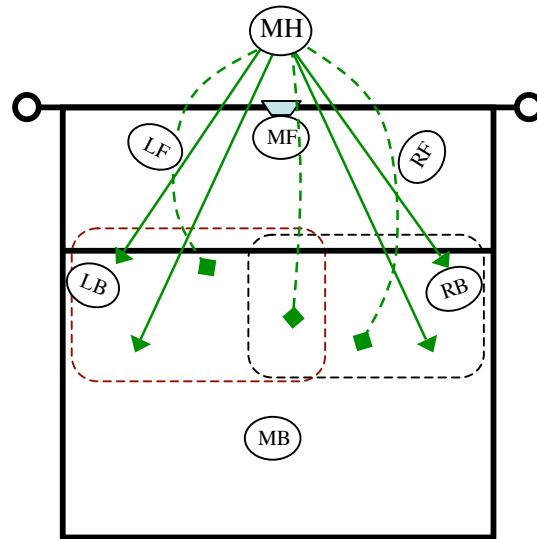

LB looks for shots hit towards her base position. The next priority is the shot hit deeper towards the corner; LB has to step into the court and take that also. The next shots to worry about are tips and off-speed shots to her half of the court. RB has the same responsibilities on the other side of the court. If possible, the LB should take priority for tips towards the middle. This frees the setter (if she were the RB) to go and set.

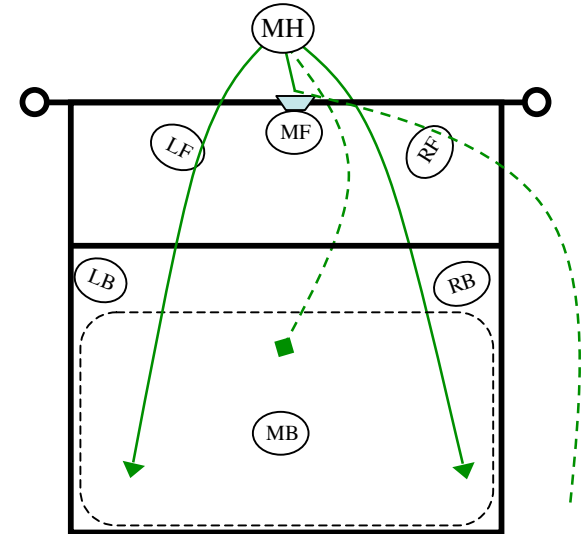

MB has responsibility for the back half of the court. If the block is working well, most of the balls to the back of the court should be over the block and a little slower than a full power spike, giving MB a chance to touch them. MB takes deeper tips to the middle. MB also has primary responsibility to chase balls off the block.

Defending the Middle: Single block

Defending the "2" (middle attack)

The "2" is the most common attack you are likely to see if you are playing at a level where it makes sense to single block the middle. The assignments are similar to the "1", but account for the slower tempo of the set. The "1" happens so fast it depends more on the setter's placement while the speed of the attack can actually limit the degree of the attacker's precision and power. The slower tempo of the "2" means the middle has time to take a bigger swing with more time to direct the shot and more opportunity to disguise the shot.

Movement from Base

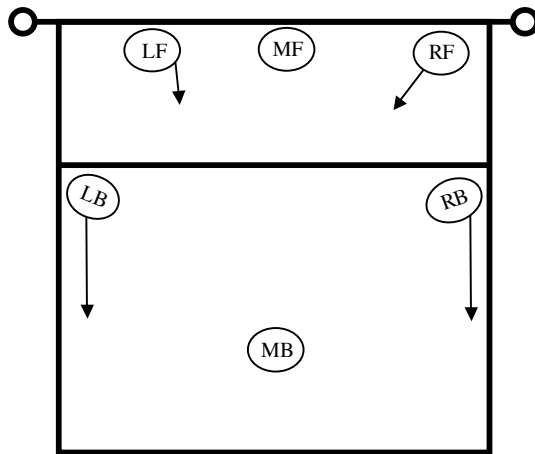

The MF is positioned to block the opposing team's middle hitter. The RF turns and takes two steps off the net. The LF also turns and takes two steps off the net. The LB drops deeper into the court, staying along the line. The RB does the same, dropping towards the corner, staying along the line. The MB reads the hitter, usually shading just left or just right of the MF.

Defensive Position

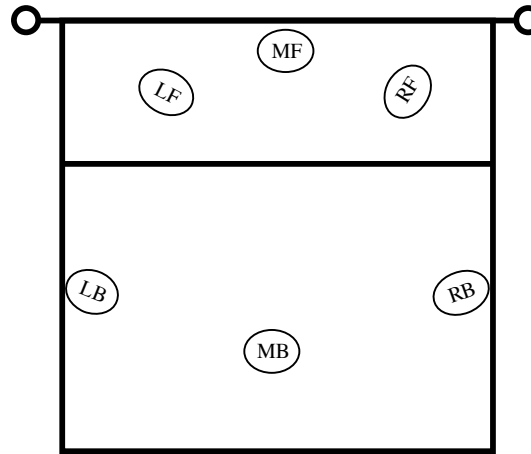

This defense reflects a couple of tendencies that many middles have when hitting the "2". They are usually able to make a more precise tip to the extreme left front (LF takes this). They are usually able to hit around a single blocker along their natural power angle (LB takes this). They are able to hit across their body deeper towards the right back of the court (RB takes this).

Areas of Coverage

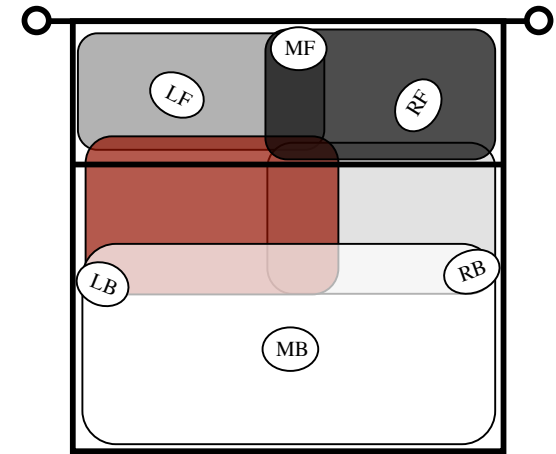

This shows the basic coverage areas for each digger. The block has primary responsibility for protecting the middle of the court and the hitter's power angle. Note that all the diggers overlap to some extent.

Defending the Middle: Single block

Defending the "2" (middle attack)

A closer look at defensive responsibilities for specific attacks

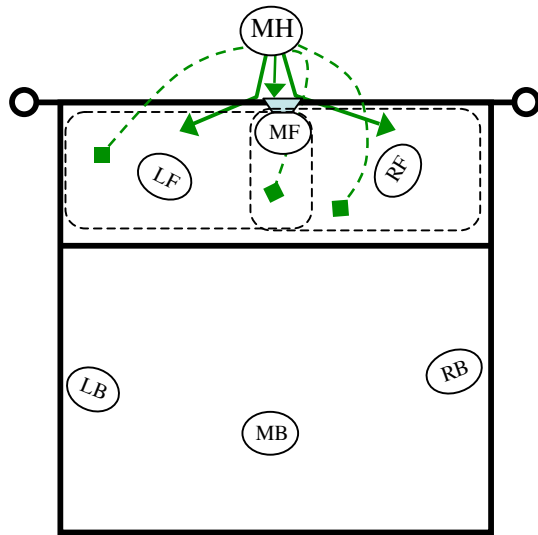

MF blocks, protecting the middle of the court. The LF looks first for tips and off-speed shots to her half of the court. In this case, the deflection is a lower priority - since this is a slower developing play, your middle should be getting a solid, well-formed block up. The RF does the same on the other side. If possible, the RF should take priority for tips towards the middle. This frees the LF to transition to hit. The set to LF is usually the easiest one, so you will often want to prioritize that shot in transition.

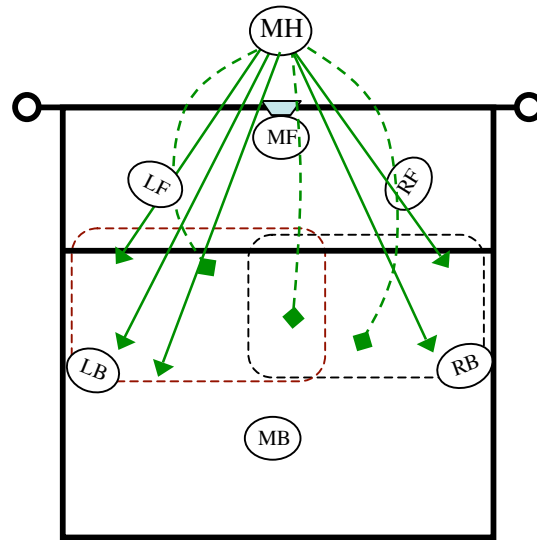

LB looks for shots hit around the block towards the spot where she is positioned along the sideline. This is the power shot for most middles hitting the "2". The LB can slide towards the middle of the court from this position if she sees the hitter turning that way. Most middles will have trouble hitting hard shots at a downwards angle closer to the 10-foot line. If they do - consider double blocking! The next shots to worry about are tips and off-speed shots to her half of the court. RB has the same responsibilities on the other side of the court. LB takes priority for tips towards the middle.

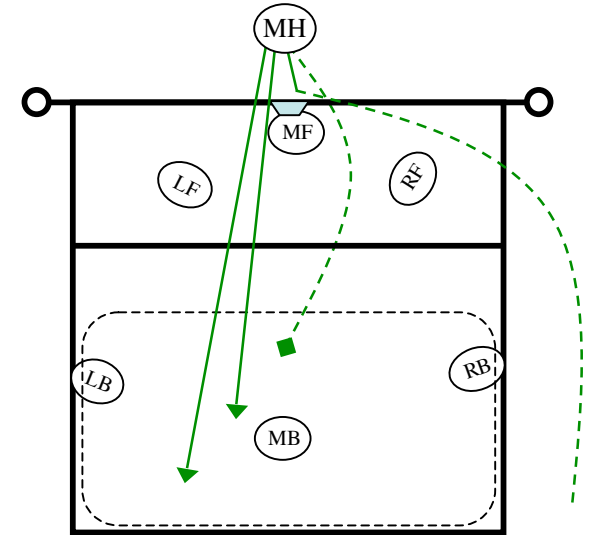

MB has responsibility for the middle back part of the court. She should dig balls hit just to the left or right of the middle. She should try to cross behind the LB or RB when going for a ball, giving them priority. MB takes deeper tips to the middle. MB also has primary responsibility to chase balls off the block.

Defending the Middle: Double block

Defending the "1" (quick middle attack)

Double blocking the "1" can really help blunt the advantage the other team has, but requires a pretty smart, athletic and disciplined outside hitter.

Movement from Base

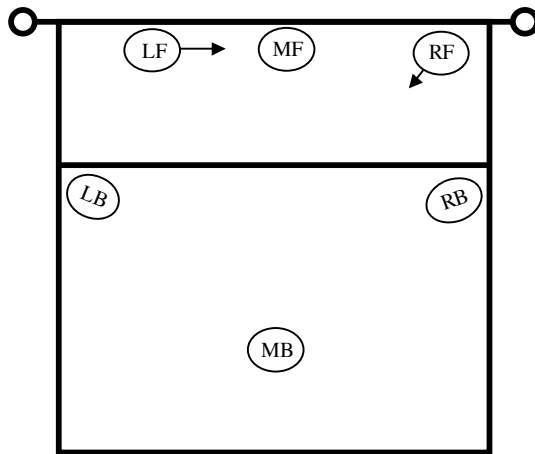

The MF is positioned to block the opposing team's middle hitter. The three backrow defenders are in base position and ready to dig. The RF turns and takes a step off the net. The LF takes a fast slide step to close to the middle blocker.

Defensive Position

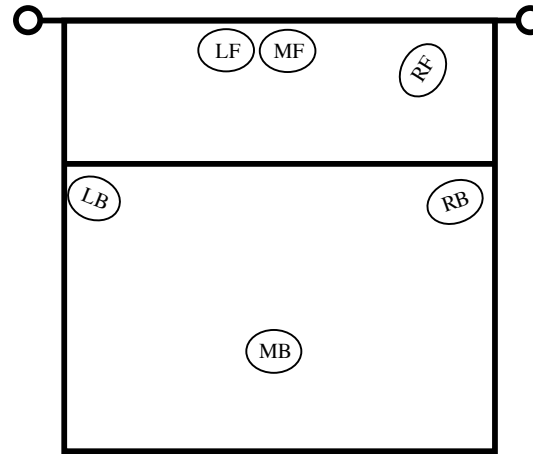

Since the "1" is so quick, middle hitters sometimes have trouble hitting it with power across their body (towards your right side defenders). Bringing the LF in as the second blocker closes down the hitter's angle and encourages her to turn her shot. This increases the chance she makes a mistake or hits something less powerful at your diggers.

Areas of Coverage

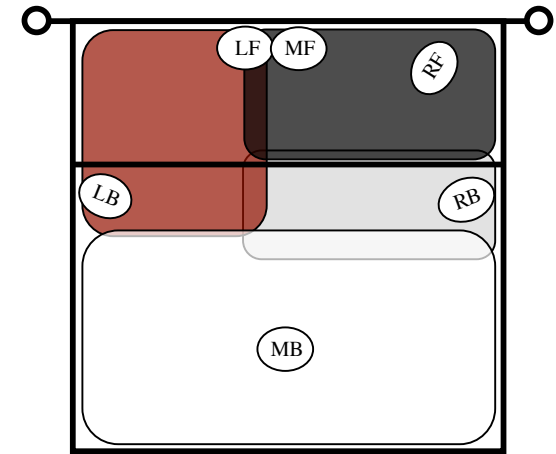

This shows the basic coverage areas for each digger. The block has primary responsibility for protecting the middle of the court and the hitter's power angle. Note that all the diggers overlap to some extent.

Defending the Middle: Double block

Defending the "1" (quick middle attack)

A closer look at defensive responsibilities for specific attacks

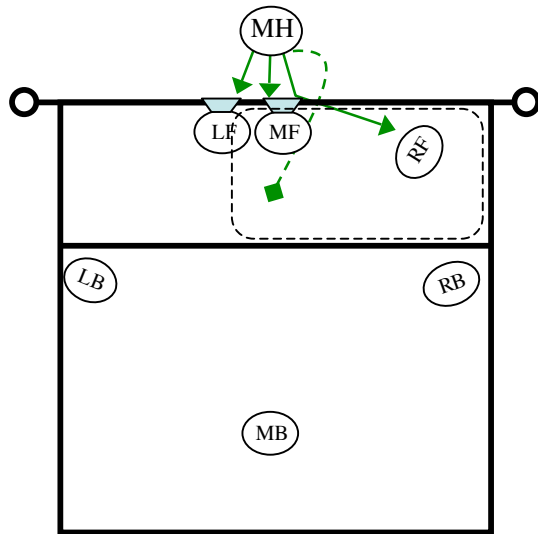

MF blocks, protecting the middle of the court. LF also blocks, but this block is more of a soft block – looking to slow down and redirect hard shots. Remember, LF is on the move and probably won't get a full jump for this block. More importantly, she should never commit to blocking the middle hitter – she still has the opposite hitter to think about. The RF looks first for tools off the block along the net. This is the shot with the least reaction time, so defend it first. The next priority is the tip over the block.

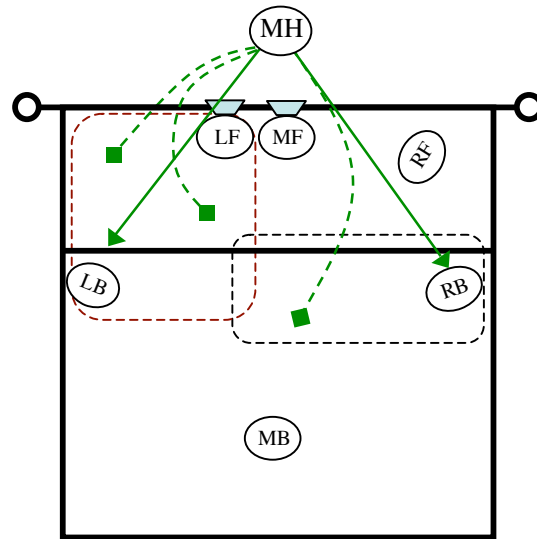

LB looks for shots that go between the blockers or over the LF. Then she covers all tips to the left front of the court. This sometimes feels risky, but remember, your LF should be taking that hard-driven ball away. RB holds position and looks first for hard-driven balls around the block and then off-speed shots towards the middle.

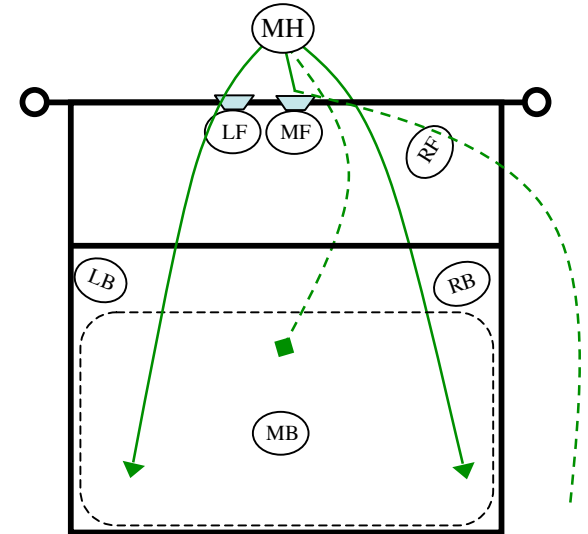

MB has responsibility for the back half of the court. If the block is working well, most of the balls to the back of the court should be over the block and a little slower than a full power spike, giving MB a chance to touch them. MB communicates with RB and takes deeper tips to the middle. MB also has primary responsibility to chase balls off the block.

Defending the Middle: Double block

Defending the "2" (middle attack)

The "2" is a slower attack than the "1". This means you have more time to bring in the outside hitter as a second blocker. In addition, this usually means the middle hitter has more opportunity to hit a wider variety of shots. The "1" happens so fast it depends more on the setter's placement while the speed of the attack can actually limit the degree of the attacker's precision and power. The slower tempo of the "2" means the middle has time to take a bigger swing with more time to direct the shot and more opportunity to disguise the shot.

Movement from Base

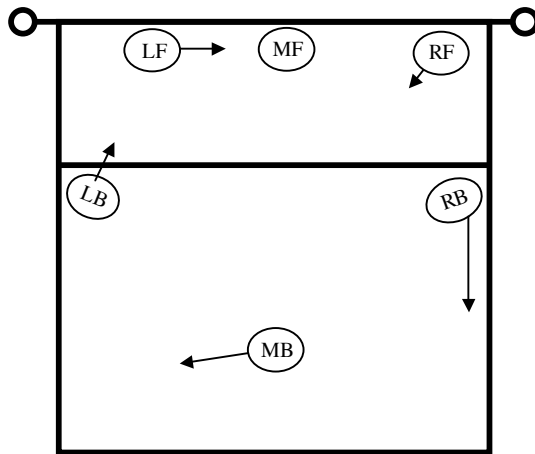

The MF still lines up to block the opposing team's middle hitter. The LF comes over to block. The RF turns and takes a step off the net. The LB slides up, looking to defend the tip. The MB slides left, looking to defend the corner. The RB slides down the line, looking to defend the hard-driven ball.

Defensive Position

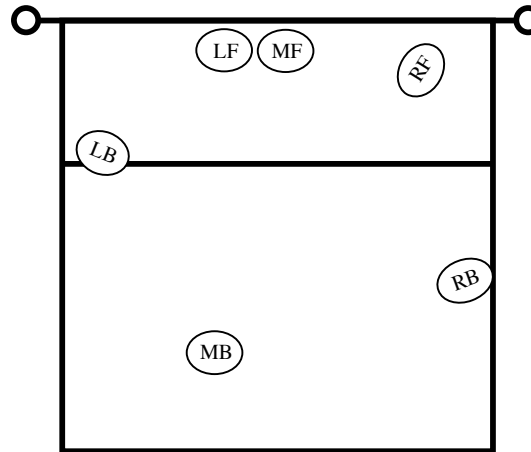

This defense reflects a couple of tendencies that many middles have when hitting the "2". They are usually able to make a more precise tip to the extreme left front (LB takes this). They are usually able to clear the block and hit along their natural power angle (MB takes this). They are able to hit across their body deeper towards the right back of the court (RB takes this).

Areas of Coverage

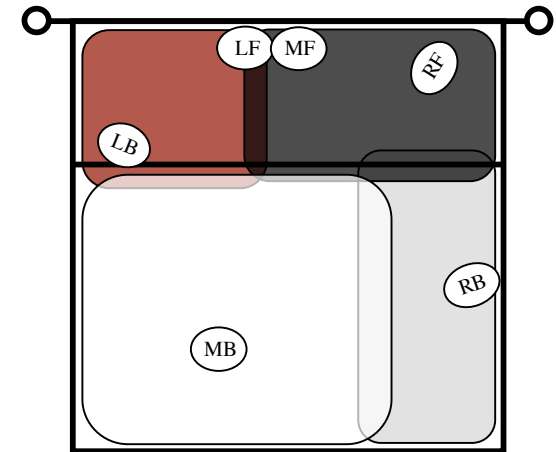

This shows the basic coverage areas for each digger. The block has primary responsibility for protecting the middle of the court and the hitter's power angle. Note that all the diggers overlap to some extent.

Defending the Middle: Double block

Defending the "2" (middle attack)

A closer look at defensive responsibilities for specific attacks

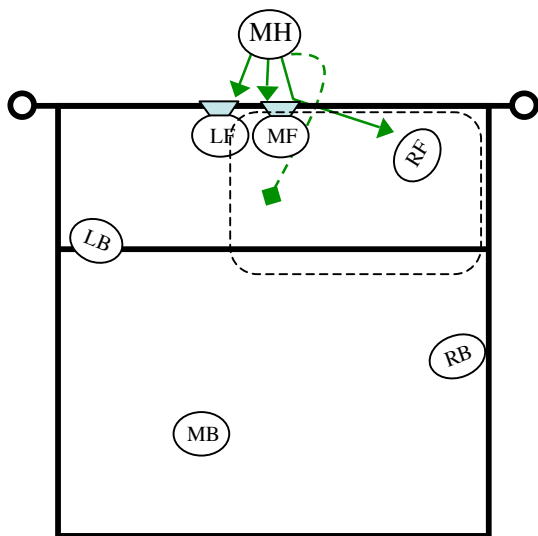

MF blocks, protecting the middle of the court. LF also blocks. This block is a full block attempt. The LF should not over-anticipate this block though. The RF looks first for tools off the block along the net. This is the shot with the least reaction time, so defend it first. The next priority is the tip over the block. RF should avoid the temptation to drop to the 10-foot line. Most middles can NOT hit this with the "2": your middle has time to block her and few middles that we face actually have the ability to elevate high enough.

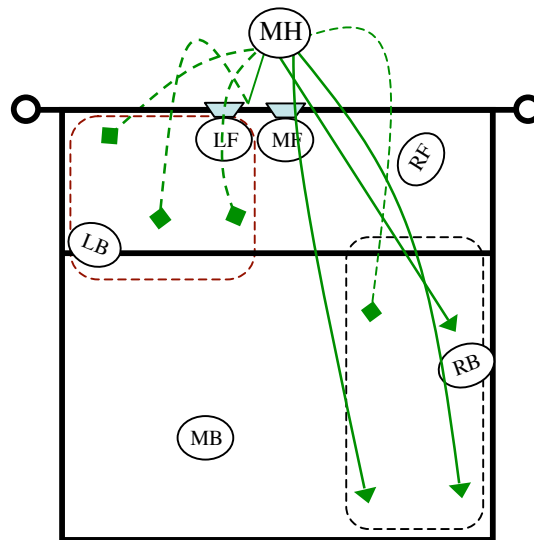

LB looks first for the tip to the extreme left front of the court. She is the ONLY defender who can cover this! The next priority is tips to the middle of the court and shots deflected off the block. She should not have to worry about hard-driven balls UNLESS the blockers are over-matched or block poorly. RB has dropped down the sideline and looks first for hard-driven balls around the block. She also covers the deep corner and off-speed shots towards the middle right.

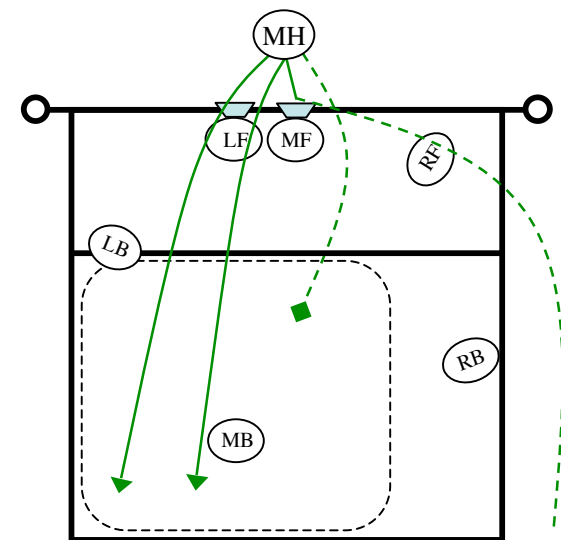

MB has responsibility for the back left two-thirds of the court. She lines up along the direction the hitter is facing. Most middles confronted with a double block can hit it over the block, but usually hit it exactly where they're facing, because their focus is clearing the block, not controlling the angle of the shot. MB takes deeper tips to the middle. MB also has primary responsibility to chase balls off the block.

Defending the Wing: Standard

Defending the "4" (outside hitter)

The "4" is probably the most common attack you will see. The opposing outside hitter is usually one of the best hitters and will see a number of sets off of good passes as well as the majority of sets off of bad passes. In the standard defense, the four diggers are equally spaced around the court, each covering a zone of the court.

Movement from Base

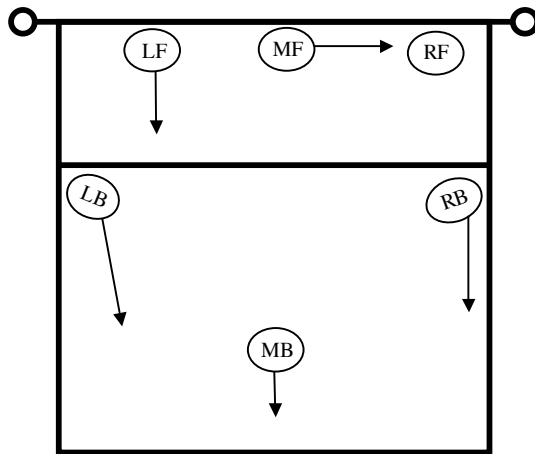

Defensive Position

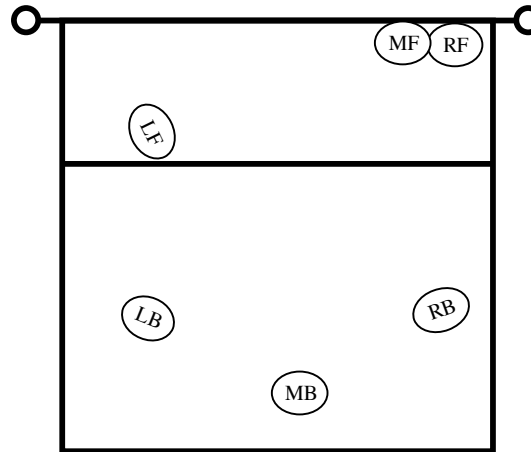

Areas of Coverage

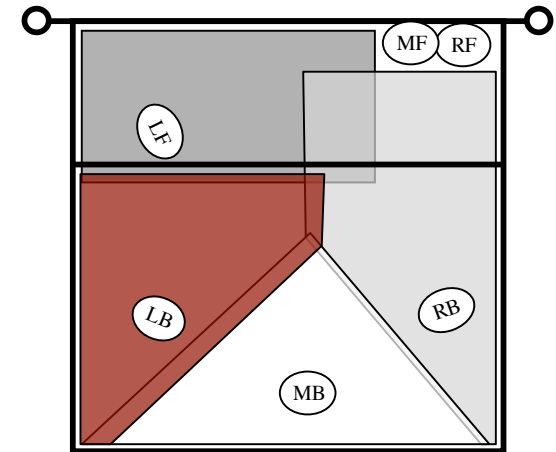

The RF looks to block the line shot. MF transitions out to block with the RF. The LF drops down to the 10-foot line. The LB slides towards the corner of the court. She's cutting off the deep angle shot to the corner and should aim to stand just to the left of the diagonal that would split the court from right front to left back. The MB drops straight back. The RB slides down the line, looking to cover the seam between the blockers

This defense reflects a basic approach to defending the outside: most of the areas of the court are covered, but the more extreme and difficult shots to make in each zone are left relatively undefended. For example, RB defends the line shot, but is 1-2 feet off the line, covering the seam between the two blockers and not the line itself.

This shows the basic coverage areas for each digger. The block has primary responsibility for protecting the middle of the court and the hitter's power angle. Note that all the diggers overlap to some extent. In general, the player closer to the net has priority if two players would be headed towards each other while going for the ball.

Defending the Wing: Standard

Defending the "4" (outside hitter)

A closer look at defensive responsibilities for specific attacks

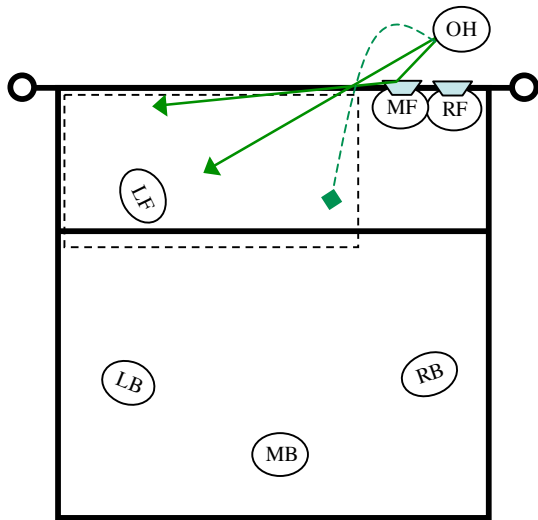

MF and RF block. With this defense, they should most often try to block the line shot - RF should position herself so her right hand is lined up with the hitter's head. LF reads the hit. If it looks like a full swing, she stays at the 10-foot line for the dig or the tool off the block. If it looks like an off-speed shot (roll or tip), she comes in and digs it. Be aggressive, but try not to overcompensate for the RB when covering off-speed shots. Remember that LF is the common outlet set, so you don't want her to take herself out of the play if another player could make the dig.

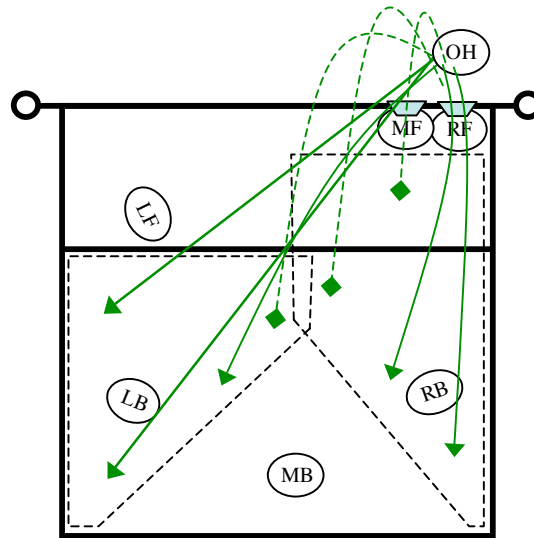

LB looks first for the shots hit around the block towards the deep corner. The next priority is balls hit at a sharper angle towards the sideline. Finally, LB looks to cut off slower balls hit towards the middle of the court and tips. RB first covers the shot over the blockers to the deep corner. Next priority is the tip directly behind the block. This is a tough one to get - RB needs to really focus on reading the hitter. Finally, RB looks to cut off slower balls hit towards the middle area of the court and tips to the middle of the court.

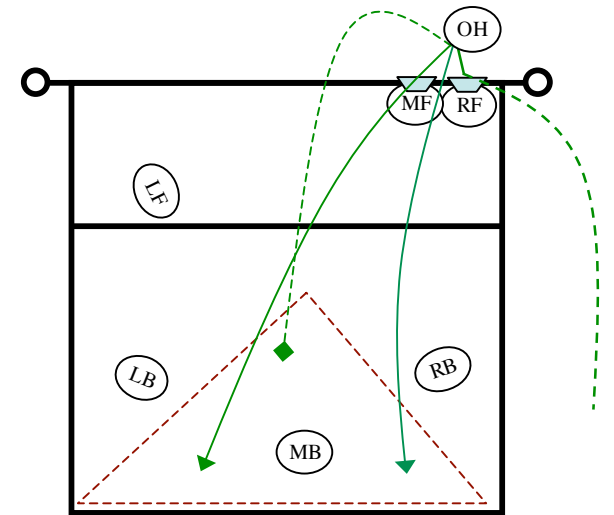

MB has responsibility for the middle area of the court and the back corners. She has to be very aggressive, but aware of what the wing players are doing. Fast wing players are going to cover more ground moving into the court - MB needs to understand what the wings will be able to get, direct traffic and cover the rest of the middle area. MB also has primary responsibility to chase balls off the block.

Defending the Wing: Tip Rotation

Defending the "4" (outside hitter)

Sometimes, you run into a hitter that tends to hit tips towards the middle of the court or just over the block with great efficiency. This places a lot of consistent pressure on the RB defender. If this attack is common, it is best to rotate the defensive coverage to take the shot away.

Movement from Base

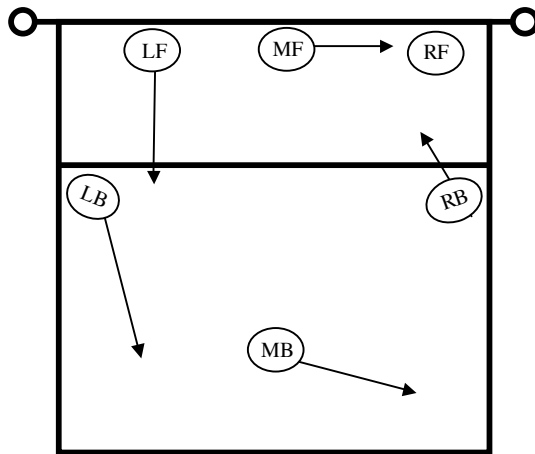

Defensive Position

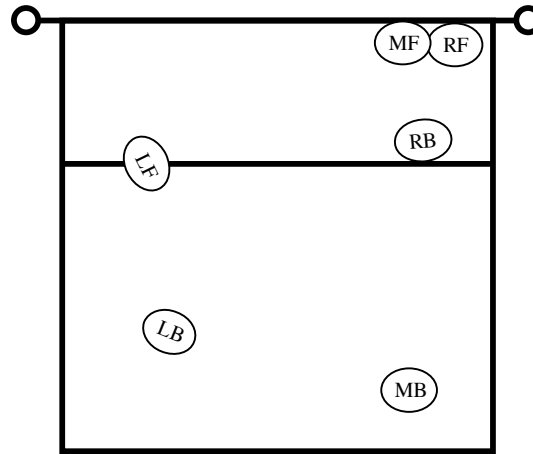

Areas of Coverage

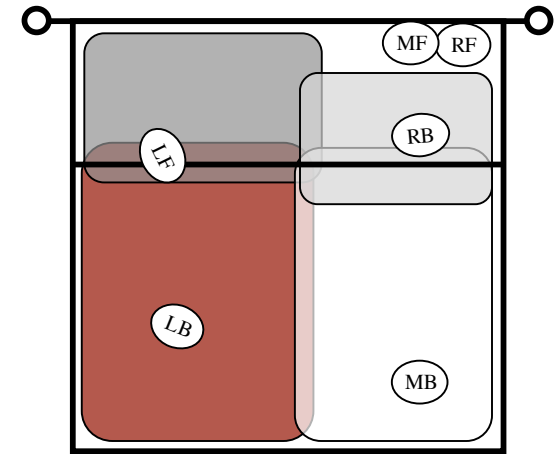

The RF looks to block the line shot. MF transitions out to block with the RF. The RB moves up and slightly into the court to cover the tip. The rest of the defenders rotate over to cover the court. The MB goes right and covers the sideline. The LB slides towards the corner of the court. The LF drops to the 10-foot line.

It is easy to see how this defense should result in a much easier time defending the tip. Each defender has a little flexibility in her positioning as each is defending a much larger portion of the court. For instance, MB has responsibility for the line. If you are facing a team that has yet to prove it can hit that shot, MB should stay a little towards the middle of the court.

This shows the basic coverage areas for each digger. The block has primary responsibility for protecting the middle of the court and the hitter's power angle. Note that all the diggers overlap to some extent. In general, the player closer to the net has priority if two players would be headed towards each other while going for the ball.

Defending the Wing: Tip Rotation

Defending the "4" (outside hitter)

A closer look at defensive responsibilities for specific attacks

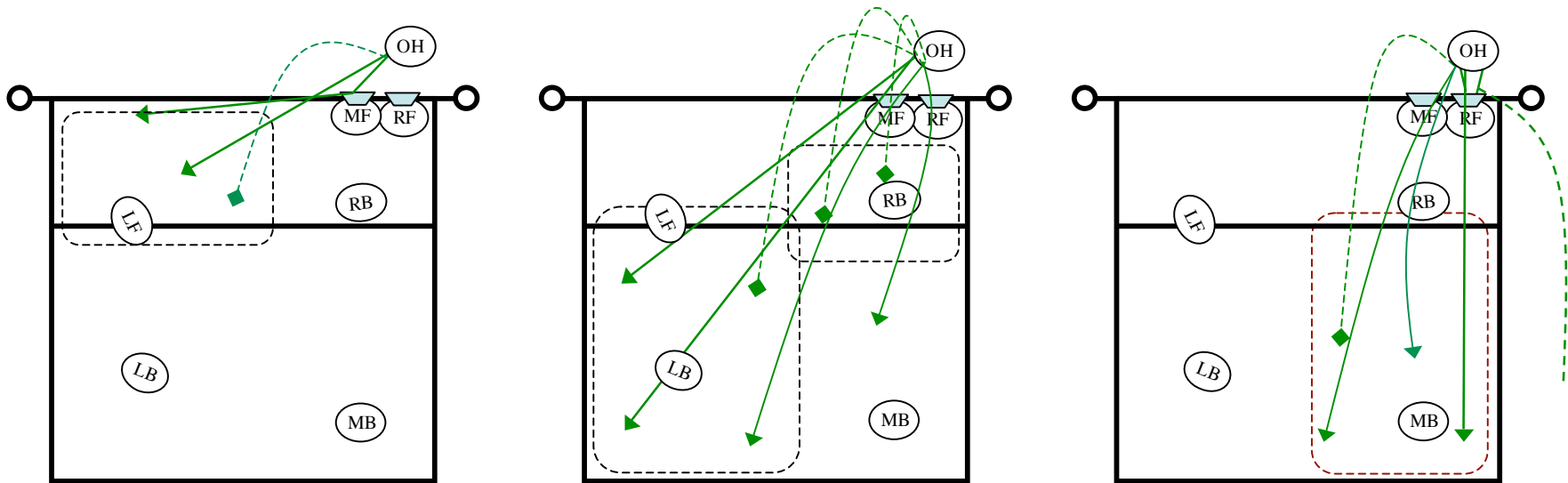

MF and RF block. With this defense, they should most often try to block the line shot - RF should position herself so her right hand is lined up with the hitter's head. LF reads the hit. If it looks like a full swing, she stays at the 10-foot line for the dig or the tool off the block. If it looks like an off-speed shot (roll or tip), she comes in and digs it. Since RB has rotated up, she should be taking more of the short middle tips.

LB looks first for the shots hit around the block towards the deep corner. As you can see, she also has to cover a much greater area to both her left and right. RB should be positioned to EASILY dig the tip over the block. Next priority is the tip towards the middle of the court - if RB can read it, she can move there in anticipation. Finally, RB looks to cut off slower balls hit towards the middle area of the court. This usually requires an overhand dig and a lot of playing experience with the MB to avoid interfering with her defense.

MB has responsibility for the right half area of the court. She has to be able to dig the line shot first. The next priority is shots hit over the RB's head, hard enough that RB can't dig it comfortably. The final priority is shots hit towards the deep middle.

Defending the Wing: Perimeter

Defending the "4" (outside hitter)

This is a more advanced defense that depends on very coordinated execution on the part of the whole team. It is best used when you have strong blockers and the other team has strong hitters that are capable of directing shots around the block. It also requires the most understanding of each position and the most discipline to execute well.

Movement from Base

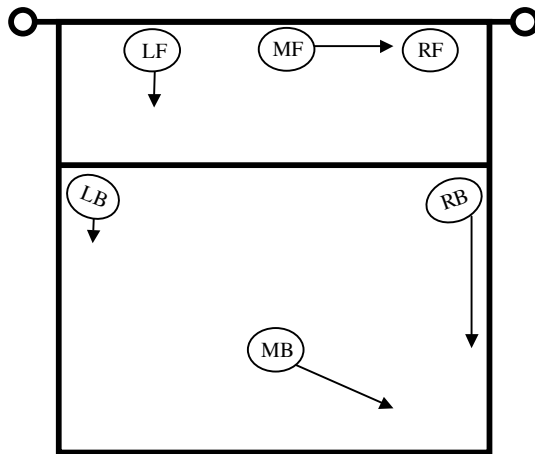

Defensive Position

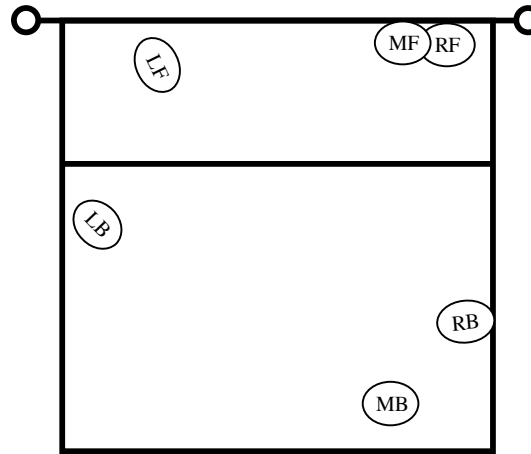

Areas of Coverage

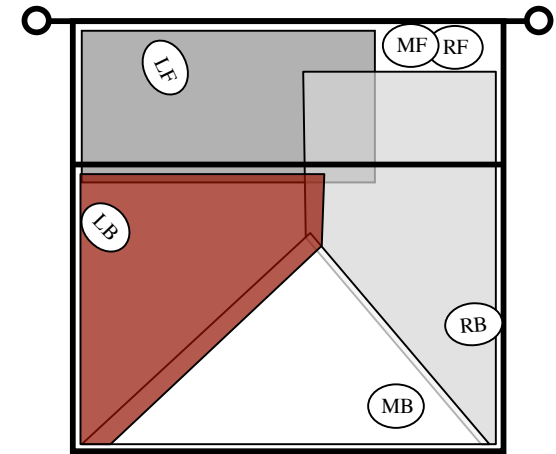

The RF looks to block the angle shot. She lines up on the hitter's hand, leaving space between herself and the antenna. MF transitions out to block with the RF. The LF opens up to the court and takes one step off the net. The LB moves back to the sideline and lines up on the left shoulder of MB, keeping the hitter's body in sight. RB drops back and gets her right foot planted on the sideline. MB drops back and towards the right sideline.

This defense usually confuses people at first. Players are initially unnerved by the amount of space left open in back left and by the degree of apparent overlap between pairs of diggers. As mentioned earlier, defenses work together and anticipate the most common and most difficult to defend shots. This is a prime example of those theories in action, as you will see on the next page.

This shows the basic coverage areas for each digger. The block has increased responsibility for protecting the middle of the court and the deep angle. Note that the zones defended are similar to the standard defense, but, due to initial positioning, certain areas of the court are going to be difficult, if not impossible, for the digger to reach in time.

Defending the Wing: Perimeter

Defending the "4" (outside hitter)

A closer look at defensive responsibilities for specific attacks

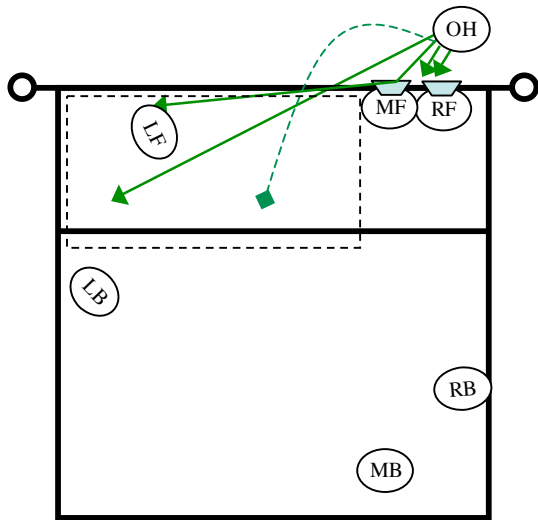

MF and RF block. With this defense, they usually block the angle shot, protecting the deep corner and trying to force shots hit towards the corner high and out. LF first defends the tool off the MB's hand - she must stay near the net for this. This result gives her the least reaction time, so she should position herself to take it first. The second priority is tips towards the middle of the court. The third priority is hard-driven sharp angle shots. LF has to learn NOT to reach out for hard-driven balls to her right and near chest level. This ball is touchable, but is almost impossible for LF to dig with control; LB has a much better chance.

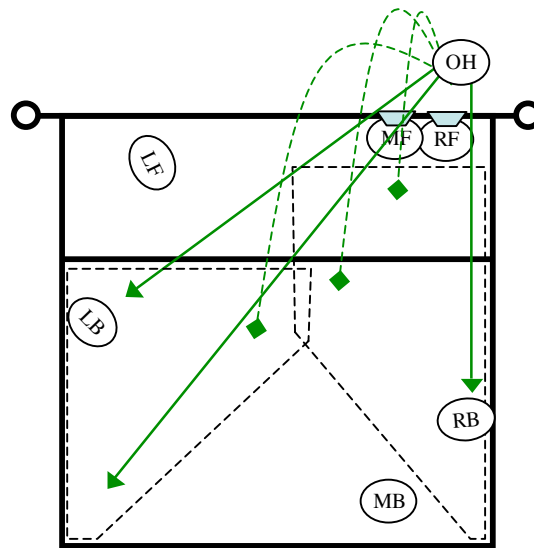

LB looks first for the shots hit around the block on the angle. As you can see, she has not had to move very much down the line. Blockers are defending the deeper shot; LB looks for the shot AROUND the block to the sideline. She next looks to dig shots hit over the block to the deep corner. Finally, she takes roll shots to the middle. RB has her right foot on the sideline and defends the line shot. The next priorities are tips and roll shots to the middle. RB has to learn NOT to reach for hard-driven balls to her left near chest level.

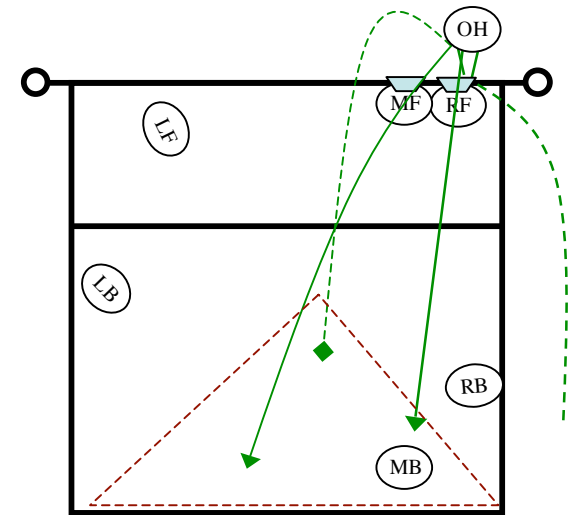

MB is first responsible for the hard-driven shot over the seam of the block to the endline. This is a very common power shot for many hitters and is not usually diggable by RB (who will have to reach up and to her left to touch the ball). MB also has to look for shots hit more towards the middle of the court and then roll shots to the deep middle part of the court. As always, MB has primary responsibility for running down balls hit off the block and deep.

Defending the Wing: Standard

Defending the "back 4" (right side hitter)

Depending on the level, the right side can be a below average hitter or a very dangerous offensive weapon. For the most part, we treat the right side hitter defense as a mirror image of the Standard defense for the outside hitter.

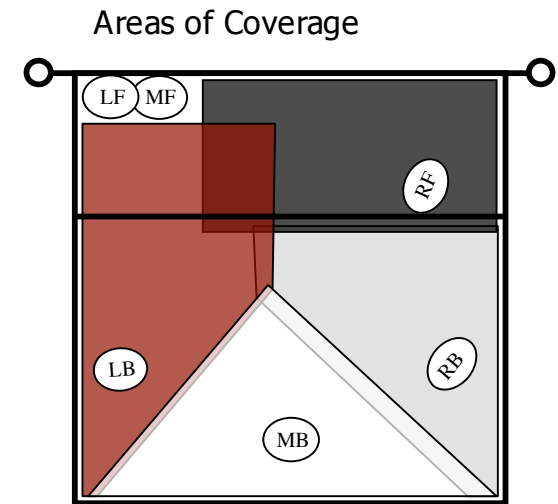
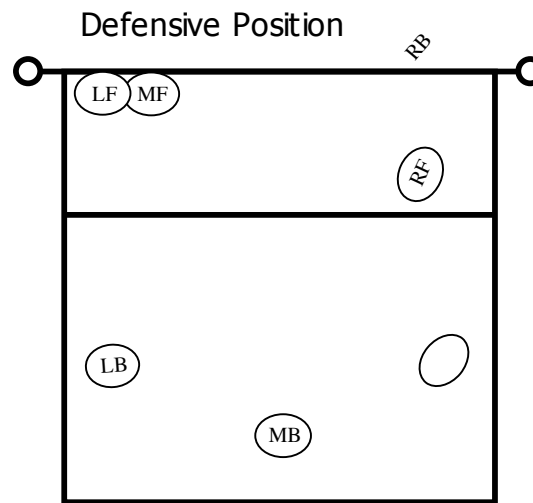
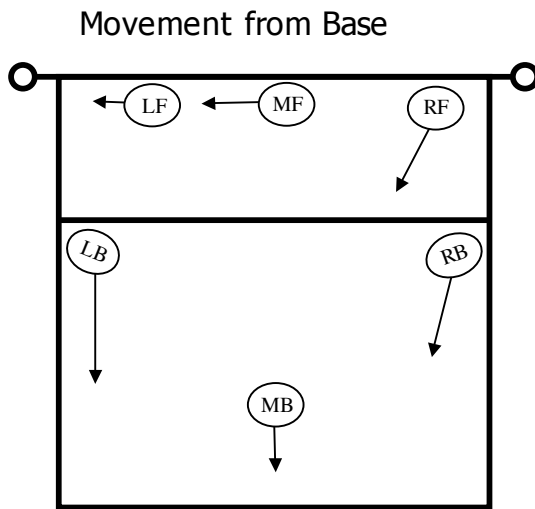

The LF looks to block the line shot. MF transitions out to block with the LF. The RF drops down to the 10-foot line. The RB slides towards the corner of the court. She's cutting off the deep angle shot to the corner and should aim to stand just to the right of the diagonal that would split the court from right front to left back. The MB drops back. The LB slides down the line, looking to cover the seam between the blockers

This defense reflects a basic approach to defending the hitter: most of the areas of the court are covered, but the more extreme and difficult shots to make in each zone are left relatively undefended. For example, LB defends the line shot, but is 1-2 feet off the line, covering the seam between the two blockers and not the line itself.

This shows the basic coverage areas for each digger. The block has primary responsibility for protecting the middle of the court and the hitter's power angle. Note that all the diggers overlap to some extent. In general, the player closer to the net has priority if two players would be headed towards each other while going for the ball.

Defending the Wing: Standard

Defending the "back 4" (right side hitter)

A closer look at defensive responsibilities for specific attacks

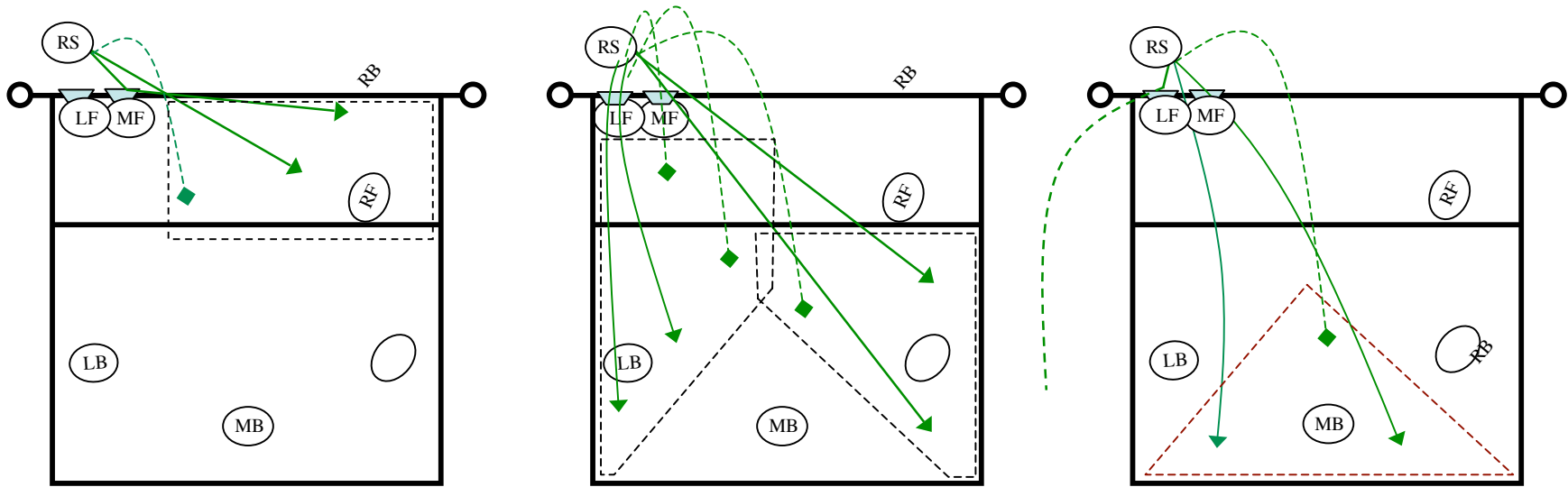

MF and LF block. With this defense, they should most often try to block the line shot - LF should position herself so her left hand is lined up with the hitter's head. RF reads the hit. If it looks like a full swing, she stays at the 10-foot line for the dig or the tool off the block. If it looks like an off-speed shot (roll or tip), she comes in and digs it. RF has to be careful not to overplay this shot. If RF moves to the middle of the court and crosses in front of RB, it reduces the court coverage and takes RF out of position for tools off the block or tips along the net.

RB looks first for the shots hit around the block towards the deep corner. The next priority is balls hit at a sharper angle towards the sideline. Finally, RB looks to cut off slower balls hit towards the middle of the court and tips. LB first covers the shot over the blockers to the deep corner. Next priority is the tip directly behind the block. This is a tough one to get - LB needs to really focus on reading the hitter. Finally, LB looks to cut off slower balls hit towards the middle area of the court and tips to the middle of the court.

MB has responsibility for the middle area of the court and the back corners. She has to be very aggressive, but aware of what the wing players are doing. Fast wing players are going to cover more ground moving into the court - MB needs to understand what the wings will be able to get, direct traffic and cover the rest of the middle area. MB also has primary responsibility to chase balls off the block.

Defending the Wing: Tip Rotation

Defending the "back 4" (right side hitter)

If the right side tends to tip a lot, you can switch into this defense.

Movement from Base

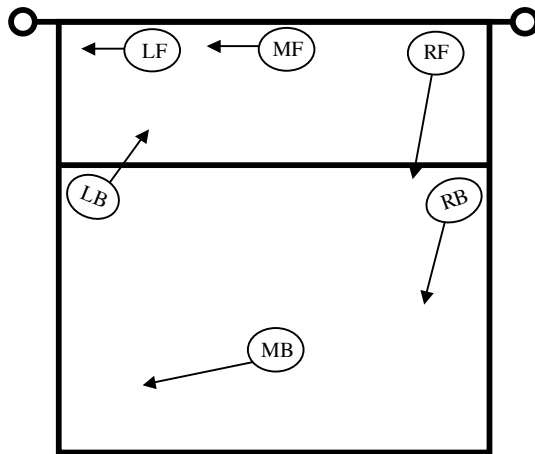

The LF looks to block the line shot. MF transitions out to block with the RF. The LB moves up and slightly into the court to cover the tip. The rest of the defenders rotate over to cover the court. The MB goes left and covers the sideline. The RB slides towards the corner of the court. The RF drops to the 10-foot line.

Defensive Position

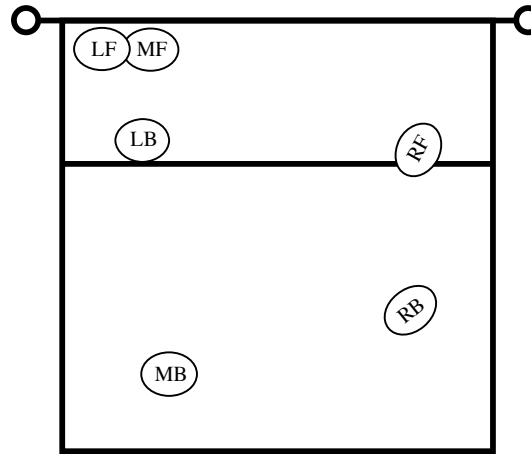

It should be easy to see how LB takes away the tip. Each defender has a little flexibility in her positioning as each is defending a much larger portion of the court. For instance, MB has responsibility for the line. If you are facing a team that has yet to prove it can hit that shot, MB should stay a little towards the middle of the court.

Areas of Coverage

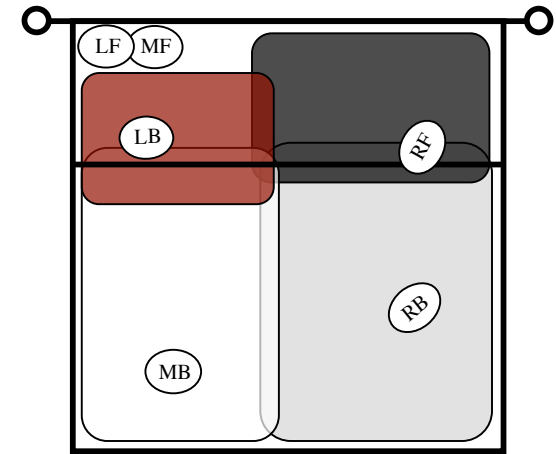

This shows the basic coverage areas for each digger. The block has primary responsibility for protecting the middle of the court and the hitter's power angle. Note that all the diggers overlap to some extent. In general, the player closer to the net has priority if two players would be headed towards each other while going for the ball.

Defending the Wing: Tip Rotation

Defending the "back 4" (right side hitter)

A closer look at defensive responsibilities for specific attacks

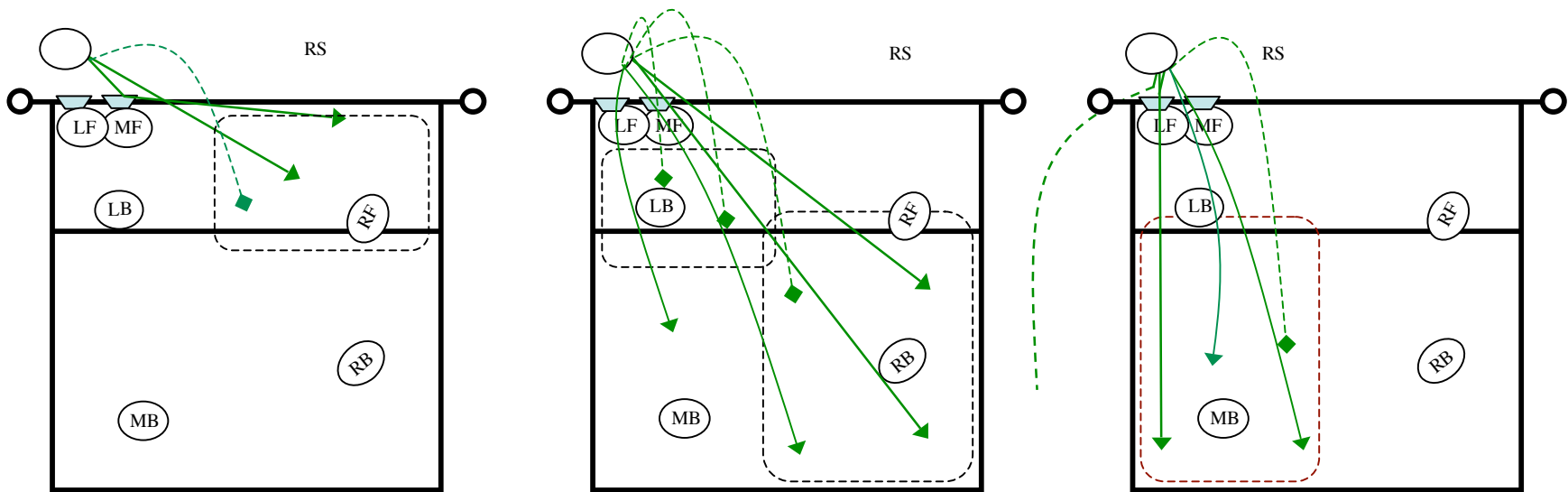

MF and LF block. With this defense, they should most often try to block the line shot - LF should position herself so her right hand is lined up with the hitter's head. RF reads the hit. If it looks like a full swing, she stays at the 10-foot line for the dig or the tool off the block. If it looks like an off-speed shot (roll or tip), she comes in and digs it. Since LB has rotated up, she should be taking more of the short middle tips instead of the RF here, so communicate and work together on this.

RB looks first for the shots hit around the block towards the deep corner. As you can see, she also has to cover a much greater area to both her left and right. LB should be positioned to EASILY dig the tip over the block. Next priority is the tip towards the middle of the court - if LB can read it, she can move there in anticipation. Finally, LB looks to cut off slower balls hit towards the middle area of the court. This usually requires an overhand dig and a lot of playing experience with the MB to avoid interfering with her defense.

MB has responsibility for the left half area of the court. She has to be able to dig the line shot first. The next priority is shots hit over the LB's head, hard enough that LB can't dig it comfortably. The final priority is shots hit towards the deep middle. And, as always, she has priority and directs the other defenders on balls deflected high off the block.

Defending the Wing: Perimeter

Defending the "back 4" (right side hitter)

Again, this is a mirror image of how you defend the outside hitter. There are three common breakdowns to watch for when using this defense on the right side: LF doesn't make it over in time and keeps getting tooled; MF doesn't make it over and the block doesn't close; RB cheats in or down to the corner. To fix them, have LF commit more to the RS hitter; have MF close the block OR MB comes up a little to guard the seam; have RB stay in her spot

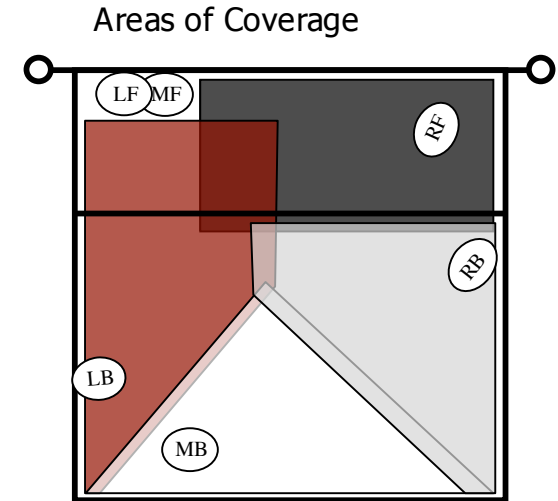
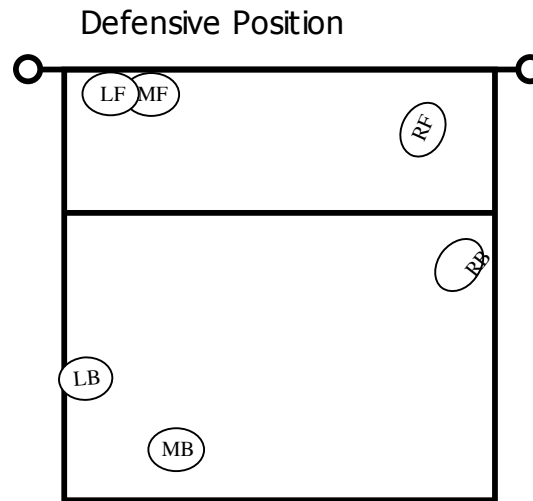
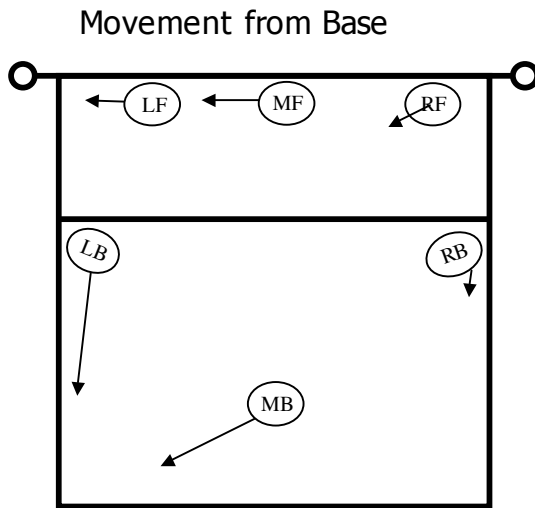

The LF looks to block the angle shot. She lines up on the hitter's hand, leaving space between herself and the antenna. MF transitions out to block with the LF. The RF opens up to the court and takes one step off the net. The RB moves back to the sideline and lines up on the left shoulder of MB, keeping the hitter's body in sight. LB drops back and gets her left foot planted on the sideline. MB drops back and towards the left sideline.

Again, the block is supposed to defend the angle and force shots towards the middle back of the court high and hopefully out. Diggers are positioned to take away remaining power shots and angles. Note that this alignment assumes a left-handed RS. If the RS is right-handed, you may need to adjust position slightly - for instance, RB may need to slide more to the deeper angle shot.

This shows the basic coverage areas for each digger. The block has increased responsibility for protecting the middle of the court and the deep angle. Note that the zones defended are similar to the standard defense, but, due to initial positioning, certain areas of the court are going to be difficult, if not impossible, for the digger to reach in time.

Defending the Wing: Perimeter

Defending the "back 4" (right side hitter)

A closer look at defensive responsibilities for specific attacks

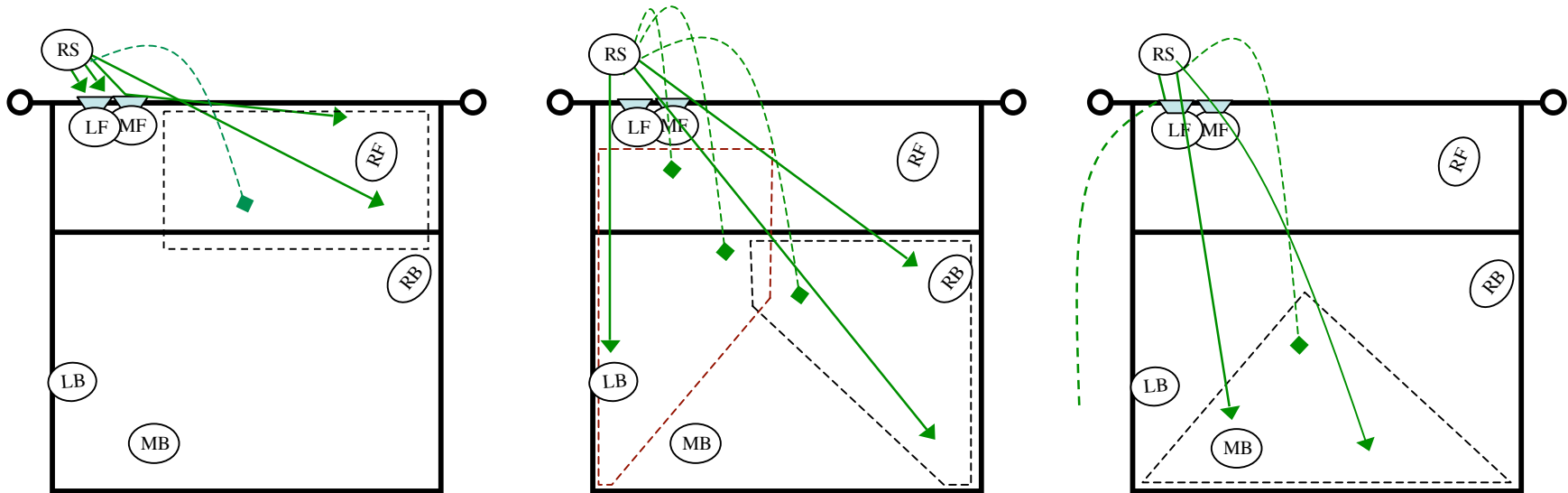

MF and LF block. With this defense, they usually block the angle shot, protecting the deep corner and trying to force shots hit towards the corner high and out. RF first defends the tool off the MB's hand - she must stay near the net for this. This result gives her the least reaction time, so she should position herself to take it first. The second priority is tips towards the middle of the court. The third priority is hard-driven sharp angle shots. RF has to learn NOT to reach out for hard-driven balls to her right and near chest level. This ball is touchable, but is almost impossible for RF to dig with control; RB has a much better chance.

RB looks first for the shots hit around the block on the angle. As you can see, she has not had to move very much down the line. Blockers are defending the deeper shot; RB looks for the shot AROUND the block to the sideline. She next looks to dig shots hit over the block to the deep corner. Finally, she takes roll shots to the middle. LB has her right foot on the sideline and defends the line shot. The next priorities are tips and roll shots to the middle. LB has to learn NOT to reach for hard-driven balls to her left near chest level.

MB is first responsible for the hard-driven shot over the seam of the block to the endline. This is a very common power shot for many hitters and is not usually diggable by LB (who will have to reach up and to her left to touch the ball). MB also has to look for shots hit more towards the middle of the court and then roll shots to the deep middle part of the court. As always, MB has primary responsibility for running down balls hit off the block and deep.

Which Defense When?

Knowing which defensive alignment to use requires balancing a lot of different factors, but many situations can be covered if you try remember and answer a couple key questions. Remember that setting up your defense is really about understanding the interaction among the hitters, the blockers and the defenders. So it's useful to think about the following questions:

What is the hitter likely to hit? What is the hitter able to hit?

For example, if you decide to double block the middle, you are usually assuming that 1) she will be hitting the "1" and therefore the middle will need some help and 2) she will be hitting the "2" and is good enough that your defense will be at a big disadvantage if she is allowed to swing away against one blocker. Now imagine that the hitter never runs a "1", or she is not very powerful, or that she is shorter and tends to hit looping shots over the block. In this case, it may no longer be to your benefit to double block because the hitter does not hit the shots that the double block is intended to defend.

Similarly, you might play at a level where most teams have outside hitters that can't hit down the line, or aren't that tall and generally hit shots looping over your blockers, or will always tip if it's a bad set. Or you might play at a level where the outside hitters are all very strong and usually try to hit to avoid the block. Each of these situations suggests a particular defense that might be better than the others.

Can the block do its job?

The next consideration is: are your blockers doing what they're supposed to be doing in this defense. For instance, with the perimeter defense, your blockers need to be big enough and close the block well enough to protect the power angle shot and the middle of the court. If your blockers are too small you have to adjust. Maybe you switch to standard and let the diggers have more freedom to read the shot.

Another primer example is double blocking the middle. Sometimes, the outside hitter is too short to effectively help block or perhaps she's a trifle slow and the other team loves setting their opposite hitter. Then you may want to switch out of double blocking the middle.

Which Defense When? (continued)

What does the hitter like to hit?

After you've played against certain hitters, you get a feeling for their favorite shots. Maybe the player wearing #5 always likes to tip. Maybe the short blonde right side loves to hit the deep corner. Once you get a feeling for a hitter's tendencies, you absolutely should adjust the defense to try and take that away.

What are the strengths of your defenders?

This can be a little trickier to judge, but you should try to account for what kinds of things your defenders do well, or don't do well as the case may be. Ideally, you try to have one compensate for the other. For example, if you have a slower setter, you may want to shift to tip rotation to allow her to stay closer to the net. In this case, it would be ideal if you had a really good LB and MB able to cover more court. Knowing the strengths and weaknesses of your players can contribute to deciding which defense you think will serve you best.

Default Defenses

So, all that said, we usually use the following default defenses depending on the tournament level:

For C-

Use the single block defense against the middle and tip rotation defense against the wing hitters. You may need to switch to standard defense for some stronger hitters who favor the line shot and don't tip very much.

For C

Use the single block defense against the middle and standard defense against the wing hitters. You may need to switch to tip rotation for weaker hitters.

For C+

Use either the single block or double block defense against the middle and standard defense against the wing hitters. You may need to switch to perimeter against stronger hitters and tip rotation against weaker hitters.

For B- and up

Use the double block defense against the middle and perimeter defense against the wing hitters to start. You may need to switch to standard defense if the hitters can hit over the blockers cleanly.

Technical Note: Learning to Cross

One common situation that arises is what to do when a ball is hit between two players. There are two common solutions. First, you can pre-determine what areas are going to be covered by which diggers. This often happens when players have played together for a long time and know each other's abilities and responses pretty well. Often, they will simply assign the more active or quicker defender a bigger area and priority to go after certain shots.

The other common option is for the two players to learn how to cross each other's paths safely. Typically, the player closest to the net moves in front of the player further from the net.

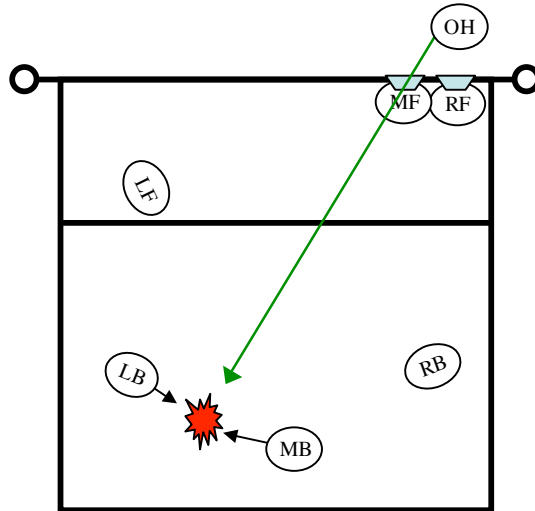

In this example, LB and MB both dive AT the ball and end up hitting each other.

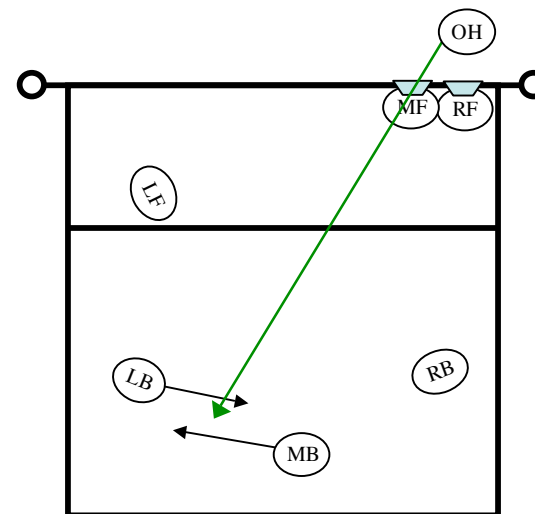

In this example, LB and MB work together a little better. LB takes priority and changes her angle towards the ball slightly, crossing in front of MB. MB changes her angle of direction so she would end up moving behind the LB.

Technical Note: Playing Outside-In

When getting set to dig a ball, it can be helpful to think about positioning yourself nearer to the edge of the area you expect to defend as opposed to right in the middle. (Here we're usually talking about very small adjustments, on the order of a foot or two.) This way, you can "cheat" and prepare yourself to have to move in only one direction. This can cut down on your reaction time and help you make a difficult dig.

If you do this, you want to try and set up so that you're closer to the perimeter of the court and trying to play a ball such that a misplay would move in a direction near your other teammates.

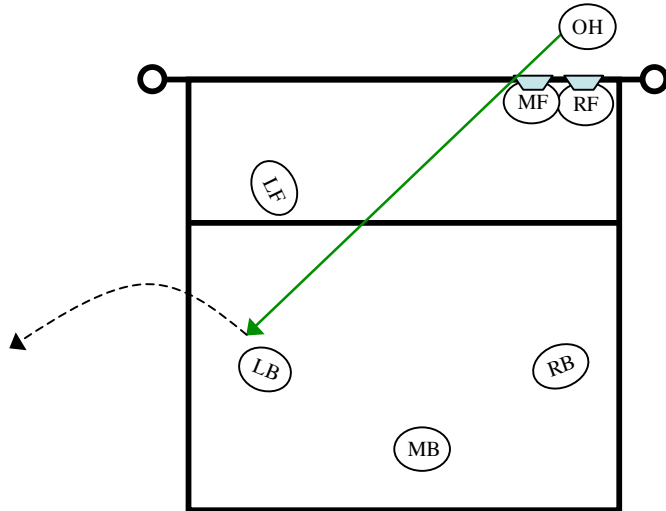

In this example, LB has set up in the middle of her zone. Since she is reaching or diving to her left for a hard-driven ball, any misplay is likely to go off the court and away from the majority of her teammates.

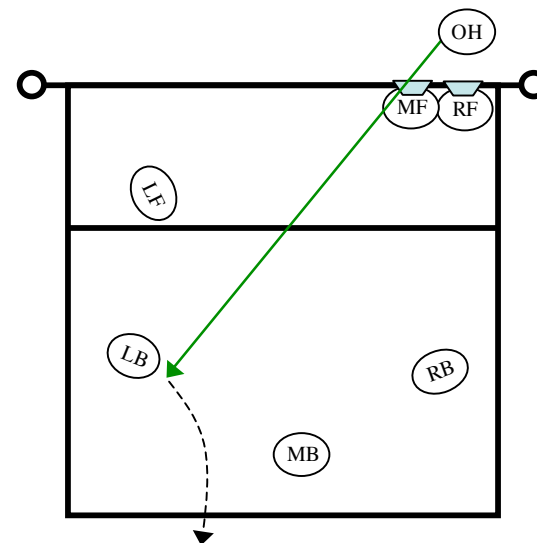

In this example, LB has shifted slightly to the left, so she is moving left to right. Now, if she makes the same misplay, reaching or diving to her right, the ball may still go off the court, but at least her teammates are closer to the ball and will have a better chance to run it down.

Basic Defensive Principles Revisited

So now that you have a sense of the defenses we run, let's revisit some of the basic principles mentioned at the beginning. This time, we'll add some more specific, concrete playing tips that apply for each principle.

A good defense works together.

Understand the role of each player.

Learn what your teammates are capable of.

Communicate, communicate, communicate!

Resolve problem situations - don't look to assign blame.

A good defense uses smart positioning.

Set up so you take away the shot that is hardest to defend (usually the least time to react).

When possible, set up so that if you have to move towards a ball (diving, reaching for a dig, etc.), your motion takes you towards teammates. This way, if there is a misplay, there is a greater chance the deflected ball goes towards teammates and not away from them

A good defense makes adjustments.

Switch defensive alignments to take away the hitter's favorite shots.

Mix and match parts of different defensive alignments to create "custom" defenses for hitters.

A good defense is disciplined.

Focus on doing your job and not worrying about the person next to you.

Do your job consistently.

A good defense works hard.

Make the effort to get into position, and ready to dig, before the ball is hit, so you are ready to move.

Don't give up on a ball - hit the floor or run it out. You will surprise yourself.

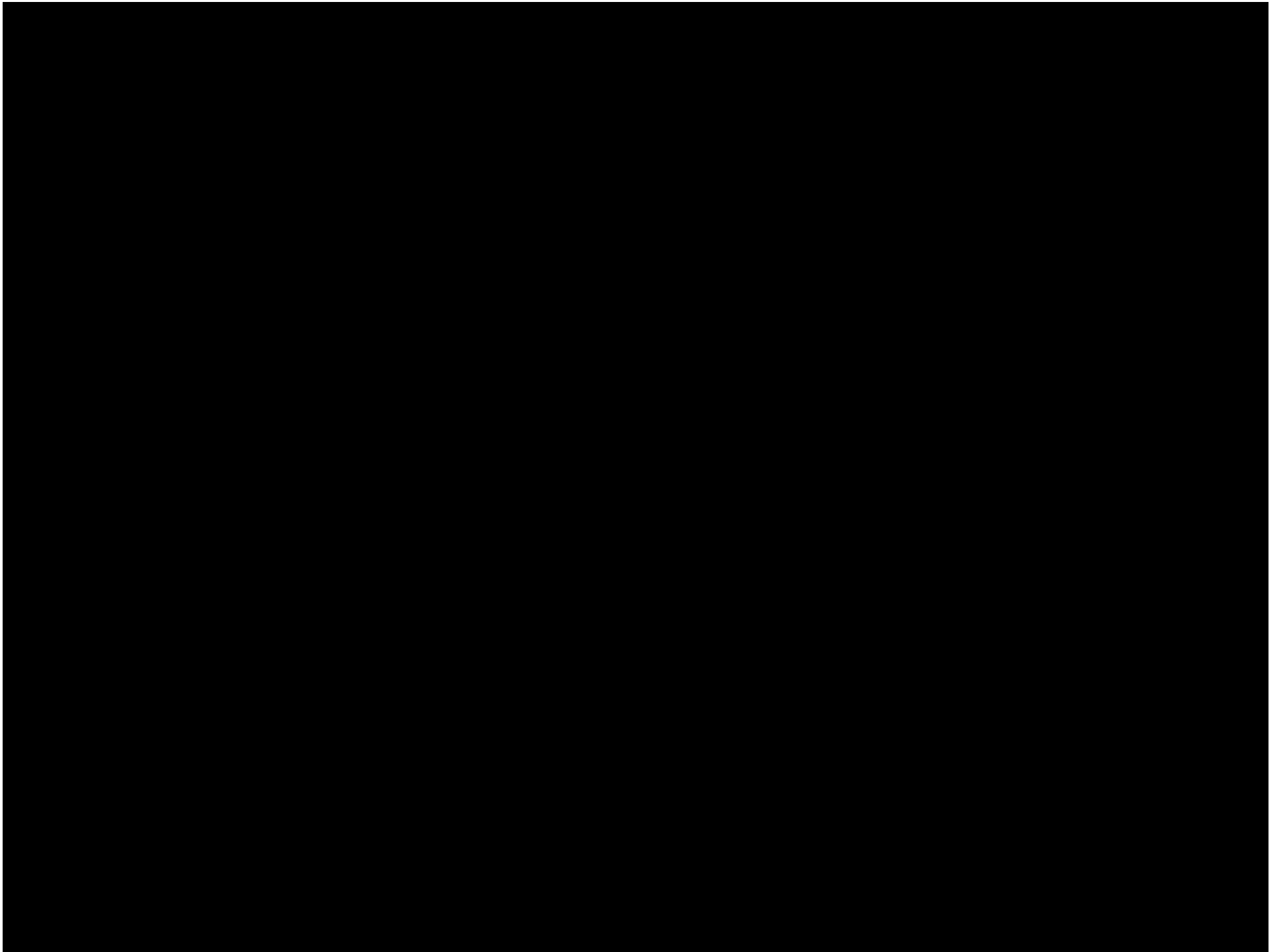

Items to Add in Future Editions

Defenses for D and D+:

- No blocker

- Head-to-head blocking

- Single blocker

Middle Up Defense and when to use it

Defending playsets

Defending the 31 and the slide