

ISR Data Analysis and Fitting 1

Ashton S. Reimer

¹Center for Geospace Studies
SRI International

15 August 2019

Outline

- 1 Introduction
- 2 Electron Density From Power
- 3 Inverse Problems
- 4 Fitting ISR Data
- 5 Derived Parameters

Quick Review

Rough summary of topics introduced in previous lectures:

- **Hardware:**

- Send megawatt pulses, receive femtowatt signals

- **Stochastic Processes:**

- Voltage samples of received signals are correlated Gaussian random variables

- **Autocorrelation Function (ACF):**

- Plasma parameters are encoded in the second moment

- **Ambiguity:**

- Measurement technique influences the measurement

- **ISR Theory:**

- Relationship between ACF (equivalently, the power spectrum) and ionospheric plasma parameters: N_e , T_e , T_i , V_{los}

Quick Review

Rough summary of topics introduced in previous lectures:

- **Hardware:** \Leftarrow **a lot of engineering**
 - Send megawatt pulses, receive femtowatt signals
- **Stochastic Processes:** \Leftarrow **statistics**
 - Voltage samples of received signals are correlated Gaussian random variables
- **Autocorrelation Function (ACF):** \Leftarrow **more statistics**
 - Plasma parameters are encoded in the second moment
- **Ambiguity:** \Leftarrow **signal processing**
 - Measurement technique influences the measurement
- **ISR Theory:** \Leftarrow **plasma physics**
 - Theoretical relationship between ACF (equivalently, the power spectrum) and ionospheric plasma parameters: N_e , T_e , T_i , V_{los}

Quick Review

But, how do we put it all together to get N_e , T_e , T_i , V_{los} ? Why should we trust the values we get?

The ISR Signal Processing Chain

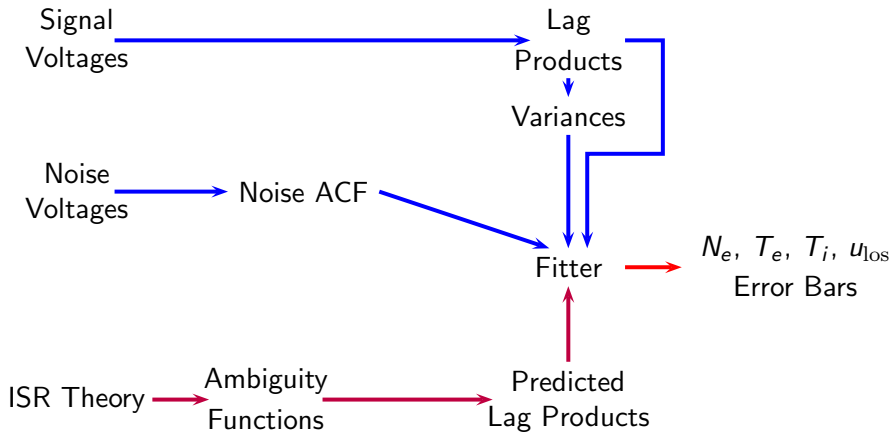

(provided by Roger Varney)

ISR Data Levels

Summary of ISR data products:

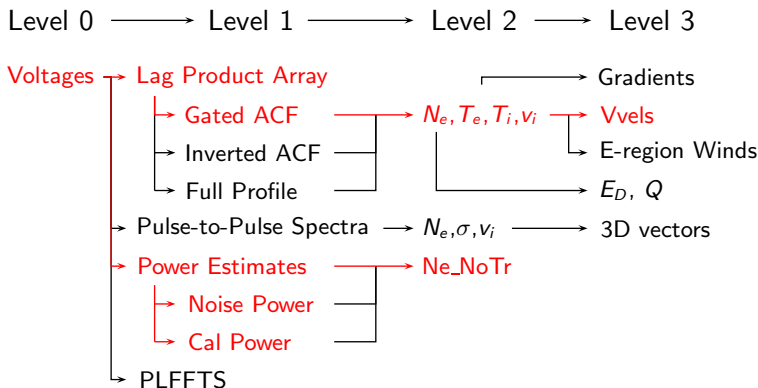

Electron Density From Power

Electron Density Determination

- ISR Equation for Power received (Watts)

$$P_{Rx} = \frac{P_{Tx}\tau_p}{R^2} K_{sys} \frac{N_e}{(1 + k^2\lambda_{De}^2)(1 + k^2\lambda_{De}^2 + T_e/T_i)}$$

$$\lambda_{De} = \sqrt{\frac{\epsilon_0 k_B T_e}{e^2 N_e}} \quad k = \frac{4\pi}{\lambda_{Tx}} \quad R = \text{Range} \quad \tau_p = \text{Pulse Length (s)}$$

- P_{Rx} in Watts: determined by comparing relative power received to direct signal injection (cal pulses)
- K_{sys} : the “System Constant” involves antenna gain, effective area, etc. For PFISR $K_{sys} \sim 10^{-19} \text{ m}^5 \text{ s}^{-1}$.
- Can determine K_{sys} by comparing estimated N_e to absolute N_e measurements, e.g.:
 - Ionosonde f_{0F2}
 - ISR plasma line frequency
 - Faraday rotation (e.g. Jicamarca)

Electron Density Estimation

Can estimate electron density using estimates of received power!

Estimators

Estimator: An estimator is a statistic. A statistic is a function used to estimate a parameter from a sample.

- Expectation value (mean):

$$E[\hat{X}] = X$$

- Mean-squared Error:

$$MSE = E[(\hat{X} - X)^2] + (E[\hat{X}] - X)^2$$

- Mean-squared Error: **Variance** + Bias

Notation:

- Measurement: \tilde{V}
- Estimate: \hat{V}

Power Estimation

Given K samples of \tilde{v}_i ,

$$\hat{P} = \frac{1}{K} \sum_{i=0}^{K-1} \tilde{v}_i \tilde{v}_i^*, \quad \text{Var} \left\{ \hat{P} \right\} = \frac{P^2}{K}$$

but in general there is noise in \tilde{v}_i , so we need to estimate the noise:

$$\hat{N} = \frac{1}{K_{\text{noise}}} \sum_{i=0}^{K_{\text{noise}}-1} \tilde{v}_{\text{noise},i} \tilde{v}_{\text{noise},i}^*$$

and remove it:

$$\hat{S} = \frac{1}{K} \sum_{i=0}^{K-1} \tilde{v}_i \tilde{v}_i^* - \hat{N}$$

$$\text{Var} \left\{ \hat{S} \right\} = \frac{(S + N)^2}{K} + \frac{N^2}{K_{\text{noise}}}$$

Power Estimation

Generally, we can design our experiment so that $K_{noise} \gg K$ then:

$$\frac{\delta \hat{S}}{S} = \frac{1}{\sqrt{K}} \left(1 + \frac{1}{S/N} \right)$$

For example, $\frac{\delta \hat{S}}{S} = 0.5$ with a $S/N = 0.1$ requires $K = 484$.

This assumes the data and noise samples are taken far apart and are uncorrelated.

Received Power Estimation

Power is in units of (ADC counts)², but we need units of watts for ISR radar equation! So we inject a known noise power from a calibration noise source. Then, received power is estimated with:

$$\hat{P}_{\text{Rx}} = kB_{\text{Rx}} T_{\text{cal}} \frac{\hat{S}}{\hat{C}}$$

$$\hat{C} = \frac{1}{K_{\text{cal}}} \sum_{i=0}^{K_{\text{cal}}-1} \tilde{v}_{\text{cal},i} \tilde{v}_{\text{cal},i}^* - \hat{N}$$

with a variance of:

$$\text{Var} \left\{ \hat{P}_{\text{Rx}} \right\} = (kB_{\text{Rx}} T_{\text{cal}})^2 \left(\frac{\text{Var} \left\{ \hat{S} \right\}}{C^2} + \frac{S^2 \text{Var} \left\{ \hat{C} \right\}}{C^4} \right)$$

where B_{Rx} is the receiver bandwidth and T_{cal} is the noise temperature of the calibration noise source.

Electron Density Estimation

Recall:

$$P_{\text{Rx}} = \frac{P_{\text{Tx}} \tau_p}{R^2} K_{\text{sys}} \frac{N_e}{(1 + k^2 \lambda_{De}^2) (1 + k^2 \lambda_{De}^2 + T_e / T_i)}$$

- Define:

$$\zeta = \frac{2}{(1 + k^2 \lambda_{De}^2) (1 + k^2 \lambda_{De}^2 + T_e / T_i)}$$

- and then solve for N_e . So an estimate of electron density, \hat{N}_e is given by:

$$\hat{N}_e = \frac{2R^2}{\zeta \tau_p K_{\text{sys}} P_{\text{Tx}}} \hat{P}_{\text{Rx}} = A \hat{P}_{\text{Rx}}$$

- with variance:

$$(\delta \hat{N}_e)^2 = \text{Var} \left\{ \hat{N}_e \right\} = A^2 \text{Var} \left\{ \hat{P}_{\text{Rx}} \right\}$$

Reporting Electron Density Estimates and Fractional Error

Corrected/Uncorrected:

$$\text{Temperature Correction: } \zeta = \frac{2}{(1 + k^2 \lambda_{De}^2) (1 + k^2 \lambda_{De}^2 + T_e/T_i)}$$

In SRI data hdf5 files:

- Uncorrected N_e , **known as “Ne_noTr”**: $\zeta = 1$.
 - $T_e/T_i = 1$
 - $k^2 \lambda_{De}^2 \ll 1$.
- N_e with model, **known as “Ne_Mod”**:
 - Compute ζ using an empirical model of T_e/T_i as a function of altitude.
- For SRI hdf5 files, electron density error is reported as fractional error, **known as “dNeFrac”**:
 - $\delta \hat{N}_e / \hat{N}_e$

Plasma parameters from ISR

So what about the rest of the plasma parameters?

Inverse Problems

Parameter Estimation and Inverse Problems

Inverse Problem: Given observations and a forward model, what are the parameters of the model that best represent the observation?

- A forward model, h , predicts observations, \mathbf{y} , for a given set of parameters \mathbf{p}

$$\mathbf{y} = h(\mathbf{p})$$

- But real measurements are noisy! So, a forward model for noisy measurements, \mathbf{z} , can be written:

$$\mathbf{z} = h(\mathbf{p}) + \mathbf{e}$$

- where \mathbf{e} is the error in the measurement due to noise. We can construct a covariance matrix of the errors:

$$\text{Cov}\{\mathbf{e}\} = \Sigma_e$$

How do we determine the best estimate of the parameters \mathbf{p} ?

Methods for Solving Inverse Problems

An incomplete list of methods:

- Least-squares
- Maximum Likelihood
- Bayesian Inference
- Maximum Entropy

Least-Squares Estimation

Least-Squares Estimate:

$$\hat{\mathbf{p}}_{\text{LS}} : \min_{\mathbf{p}} [h(\mathbf{p}) - \mathbf{z}]^T \Sigma_e^{-1} [h(\mathbf{p}) - \mathbf{z}]$$

For a diagonal Σ_e^{-1} (uncorrelated measurement errors):

$$\hat{\mathbf{p}}_{\text{LS}} : \min_{\mathbf{p}} \sum_i \frac{[h_i(\mathbf{p}) - z_i]^2}{\sigma_i^2}$$

- If \mathbf{z} is jointly gaussian, then the least-squares estimate is equivalent to the maximum likelihood estimate.
- A commonly used numerical technique for iteratively solving nonlinear least squares problems is the Levenberg-Marquardt algorithm
- Standard Levenberg-Marquardt packages:
 - FORTRAN: MINPACK lmdif.f and lmdcr.f
 - Python: `scipy.optimize.leastsq` (wrapper around lmdif and lmdcr)
 - Matlab: Optimization Toolbox lsqnonlin
 - IDL: LMFIT
- Levenberg-Marquardt requires a good initial guess

Error Propagation (Linear Least-Squares)

Linear Least-Squares $h(\mathbf{p}) = H\mathbf{p}$

$$\begin{aligned}\hat{\mathbf{p}}_{\text{LS}} &= \left[H^T \Sigma_e^{-1} H \right]^{-1} H^T \Sigma_e^{-1} \mathbf{z} \\ &= \left[\tilde{H}^T \tilde{H} \right]^{-1} \tilde{H}^T \tilde{\mathbf{z}}\end{aligned}$$

where $\tilde{H} = \Sigma_e^{-1/2} H$ and $\tilde{\mathbf{z}} = \Sigma_e^{-1/2} \mathbf{z}$

Recall the property of jointly Gaussian random variables:

$$\mathbf{Y} = A\mathbf{X} \Rightarrow \text{Cov}\{\mathbf{Y}\} = A \text{Cov}\{\mathbf{X}\} A^T$$

Thus

$$\begin{aligned}\text{Cov}\{\hat{\mathbf{p}}_{\text{LS}}\} &= \left[\tilde{H}^T \tilde{H} \right]^{-1} \tilde{H}^T \text{Cov}\{\tilde{\mathbf{z}}\} \tilde{H} \left[\tilde{H}^T \tilde{H} \right]^{-1} \\ &= \left[\tilde{H}^T \tilde{H} \right]^{-1}\end{aligned}$$

(Note $\text{Cov}\{\tilde{\mathbf{z}}\} = \Sigma_e^{-1/2} \text{Cov}\{\mathbf{z}\} \Sigma_e^{-1/2} = I$)

Error Propagation (Nonlinear Least Squares)

Suppose we are minimizing

$$\hat{\mathbf{p}}_{\text{LS}} \min_{\mathbf{p}} \sum_i \frac{[h_i(\mathbf{p}) - z_i]^2}{\sigma_i^2}$$

Linearize the problem in the vicinity of the solution

$$\text{Cov} \{ \hat{\mathbf{p}}_{\text{LS}} \} \approx [\tilde{\mathbf{J}}^T \tilde{\mathbf{J}}]^{-1}$$

where the Jacobian $\tilde{\mathbf{J}}$ is evaluated at the solution $\mathbf{p} = \hat{\mathbf{p}}_{\text{LS}}$

$$\tilde{\mathbf{J}} = \begin{pmatrix} \frac{1}{\sigma_0} \frac{\partial h_0}{\partial p_0} & \frac{1}{\sigma_0} \frac{\partial h_0}{\partial p_1} & \cdots & \frac{1}{\sigma_0} \frac{\partial h_0}{\partial p_{M-1}} \\ \frac{1}{\sigma_1} \frac{\partial h_1}{\partial p_0} & \frac{1}{\sigma_1} \frac{\partial h_1}{\partial p_1} & \cdots & \frac{1}{\sigma_1} \frac{\partial h_1}{\partial p_{M-1}} \\ \vdots & \vdots & \vdots & \vdots \\ \frac{1}{\sigma_{N-1}} \frac{\partial h_{N-1}}{\partial p_0} & \frac{1}{\sigma_{N-1}} \frac{\partial h_{N-1}}{\partial p_1} & \cdots & \frac{1}{\sigma_{N-1}} \frac{\partial h_{N-1}}{\partial p_{M-1}} \end{pmatrix}$$

$\tilde{\mathbf{J}}$ is $N \times M$ (tall and skinny)

- Levenberg-Marquart computes $\tilde{\mathbf{J}}$ at every iteration internally
- Standard packages usually have an option to return either $\tilde{\mathbf{J}}$, and/or $[\tilde{\mathbf{J}}^T \tilde{\mathbf{J}}]^{-1}$ from the last iteration

Is the result meaningful?

Two important things to check:

- evaluate the “goodness of fit”: for AMISR, reduced chi-squared is provided
- check covariance of fitted parameters

Fitting ISR Data

The ISR Signal Processing Chain

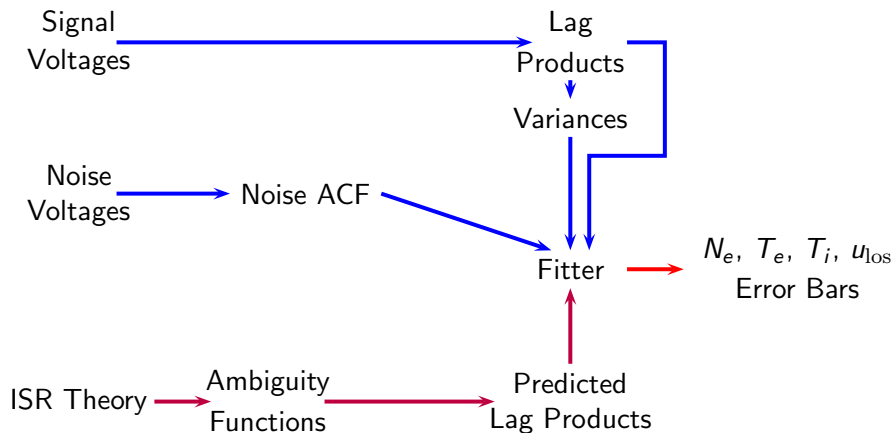

(Seen previously in Radar 3: Statistical Signal Processing by Roger Varney)

The ISR Signal Processing Chain

- Run the experiment, collect voltage samples
- Estimate ACFs from the voltage samples for each range gate
- Gate the ACFs
- Set up forward model
- Solve the inverse problem

ACF Estimation

Example: Uncoded Long Pulse

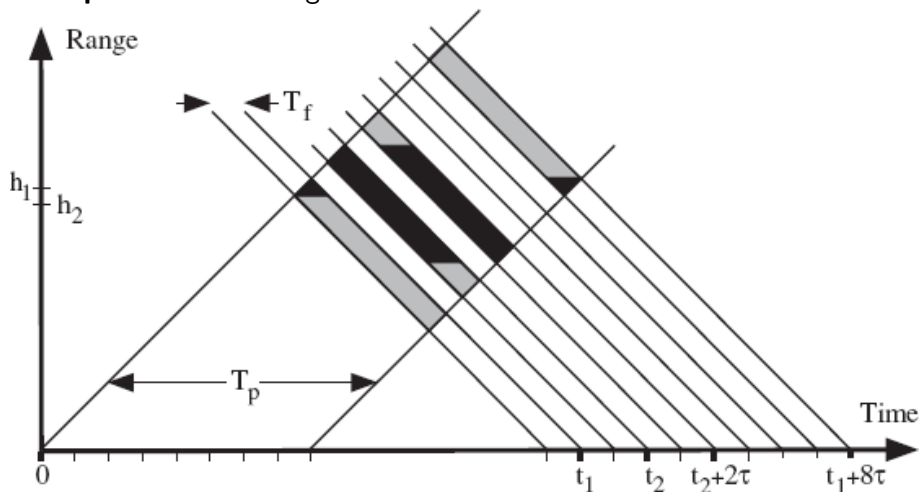

Blurring of ACFs by Ambiguity Functions

A particular exaggerated example using 1.5 ms long pulses and a profile with a sharp T_e gradient at 500 km.

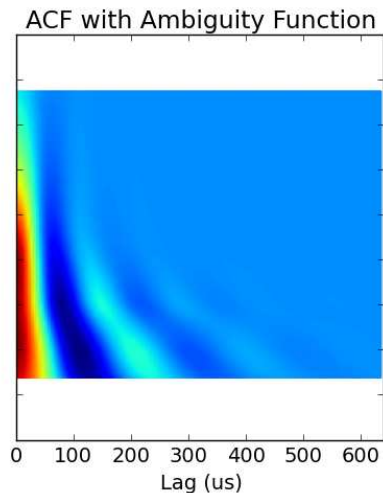
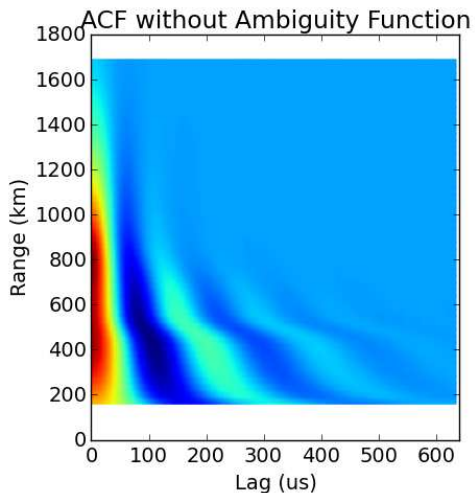

ACF Gating

Uncoded Long Pulse ACF Gating:

- Different lags have different range ambiguity
- For fitting, want all ACF lags to share common range extent

Solution: Sum Rules

- Sum lags so that all lags have the same range extent

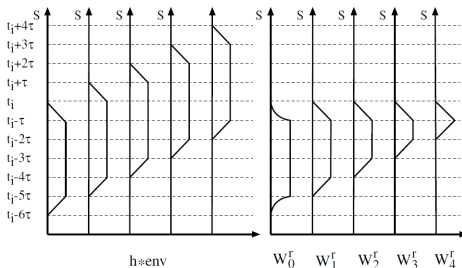
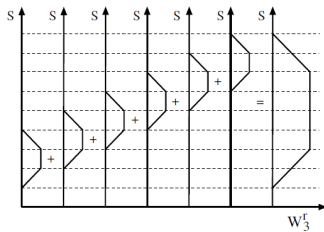
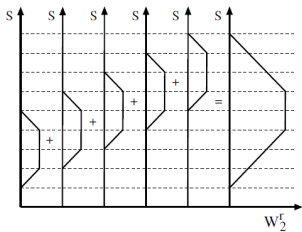
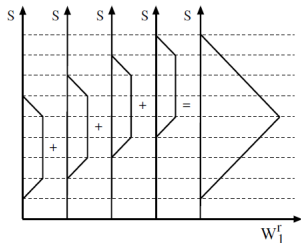
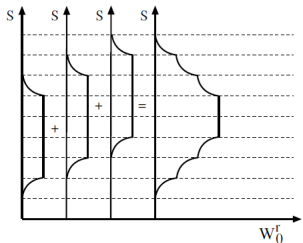

Figure from Nygrén ISR Book

ACF Gating and Sum Rules



Figures from Nygrén ISR Book

ACF Gating and Sum Rules

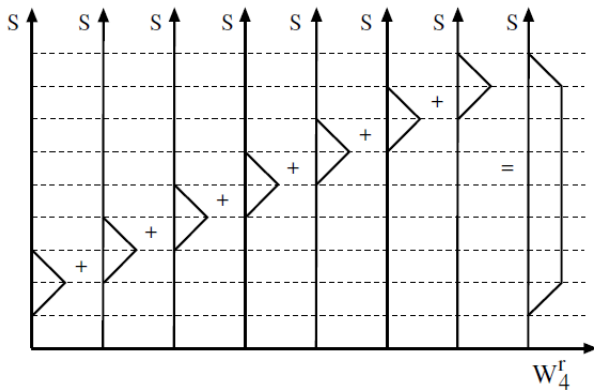

Figure from Nygrén ISR Book

Creating Forward Models

The forward model has two portions

- 1 Physics and Chemistry (ISR Theory)
 - Assume Maxwellian distributions?
 - Constraints on T_e and T_i ?
 - Constraints on ion composition? Chemistry model?
 - Magnetic field effects
- 2 Instrumental Effects and Signal Processing
 - Sampling and Aliasing
 - Windowing
 - Ambiguity Functions

Best practice is to build the instrumental effects into the forward model.

Do not manipulate the data in an attempt to undo the instrumental effects!

Solving the Inverse Problem

- gate ACF integrate in time
- evaluate ISR theory, FFT, and convolved with ambiguity functions
- Levenburg-Marquardt least-squares solver

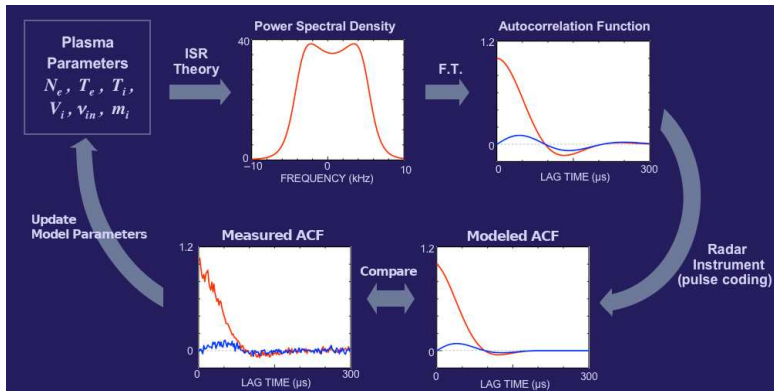

Example PFISR Long Pulse Fits

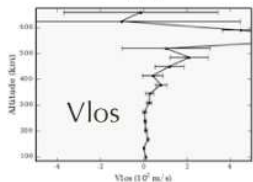
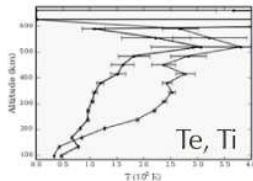
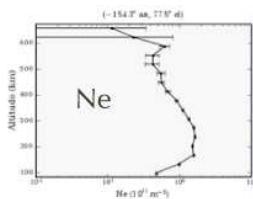
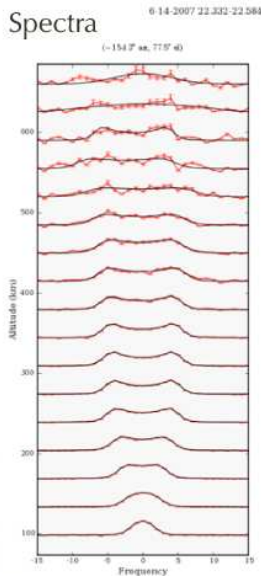
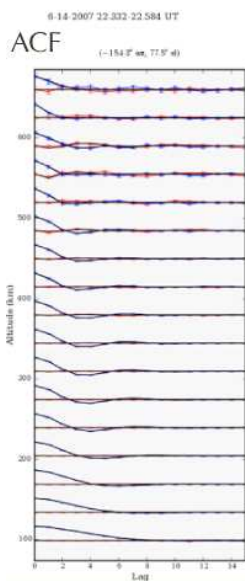

Ill-Posed and Ill-Conditioned Problems

What happens if my forward model maps different points in parameter space to almost the same points in data space?

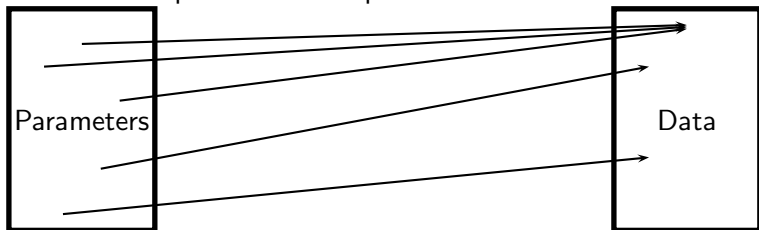

- **Ill-Posed Problem:** Multiple points in parameters space map to exactly the same point in data space.

$\left[\tilde{H}^T \tilde{H} \right]$ is singular, inverse problem is impossible

- **Ill-Conditioned Problem:** Multiple points in parameters space map to nearly the same point in data space.

$\left[\tilde{H}^T \tilde{H} \right]$ is nearly singular, inverse problem is unstable given noisy data

Ill-Conditioned ISR Theory: Molecular Ion Chemistry

Mixtures of O^+ and O_2^+ using $N_e = 10^{11}$, $T_e = T_i = 1000$ K

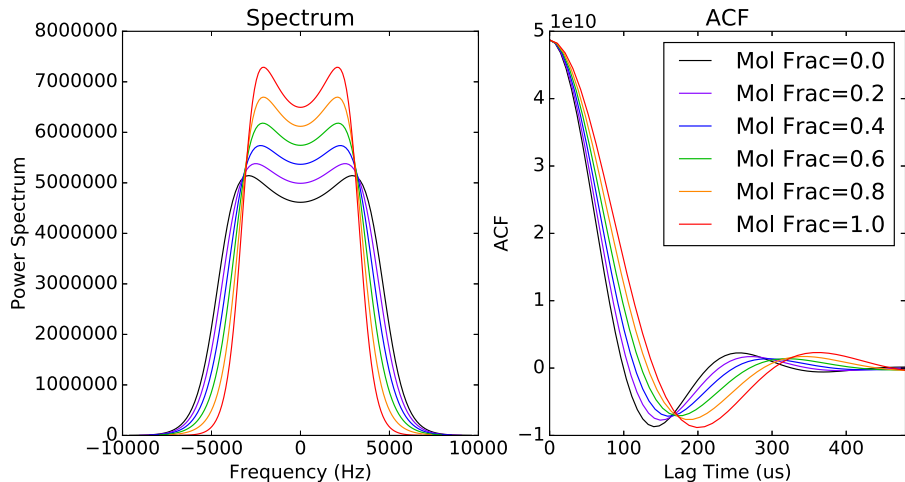

ISR spectrum measures $\sqrt{\frac{T_i}{m_i}}$, ambiguity between T_i and m_i

Derived Parameters

Jicamarca $E \times B$ Drifts

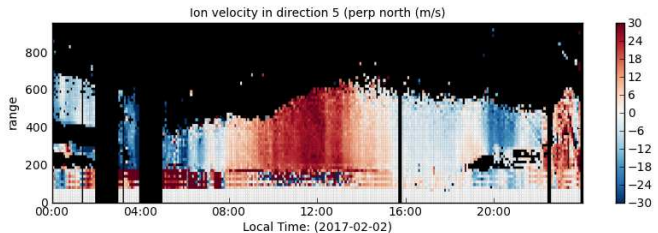
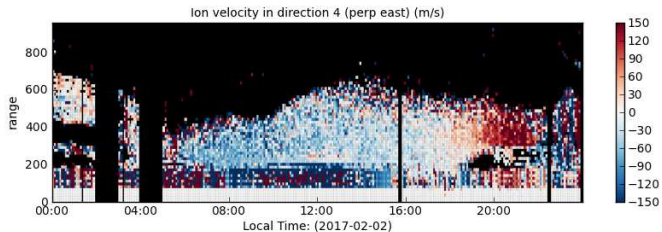
 v_2 v_1 5°

Why does zonal (u) look noisier than vertical (w)?

Error Analysis of Jicamarca Drifts

$$\begin{bmatrix} v_1 \\ v_2 \end{bmatrix} = \begin{bmatrix} \sin(2.5^\circ) & \cos(2.5^\circ) \\ -\sin(2.5^\circ) & \cos(2.5^\circ) \end{bmatrix} \begin{bmatrix} u \\ w \end{bmatrix}$$

$$\begin{bmatrix} u \\ w \end{bmatrix} = \frac{1}{2 \sin(2.5^\circ) \cos(2.5^\circ)} \begin{bmatrix} \cos(2.5^\circ) & -\cos(2.5^\circ) \\ \sin(2.5^\circ) & \sin(2.5^\circ) \end{bmatrix} \begin{bmatrix} v_1 \\ v_2 \end{bmatrix}$$

$$\begin{bmatrix} u \\ w \end{bmatrix} = \mathbf{A} \begin{bmatrix} v_1 \\ v_2 \end{bmatrix}$$

$$\begin{bmatrix} \text{Var}\{u\} & \text{Cov}\{u, w\} \\ \text{Cov}\{u, w\} & \text{Var}\{w\} \end{bmatrix} = \mathbf{A} \begin{bmatrix} \sigma_v^2 & 0 \\ 0 & \sigma_v^2 \end{bmatrix} \mathbf{A}^T$$

$$\begin{bmatrix} \text{Var}\{u\} & \text{Cov}\{u, w\} \\ \text{Cov}\{u, w\} & \text{Var}\{w\} \end{bmatrix} = \begin{bmatrix} \frac{1}{2} \frac{\sigma_v^2}{\sin^2(2.5^\circ)} & 0 \\ 0 & \frac{1}{2} \frac{\sigma_v^2}{\cos^2(2.5^\circ)} \end{bmatrix}$$

AMISR F-region 1-D Vector Electric Fields

- In F-region assume $\mathbf{v}_i = \frac{\mathbf{E} \times \mathbf{B}}{B^2}$
- Assume $\mathbf{E} \cdot \mathbf{B} = 0$ (no parallel fields)
- LOS velocity is related to \mathbf{E} perpendicular to LOS and \mathbf{B}
- Assume \mathbf{E} is uniform in magnetic longitude, but varies with magnetic latitude
- Assume \mathbf{E} fields map along equipotential field lines
- Different range gates correspond to different magnetic latitudes
- Fit for 2-components of \mathbf{E} as a function of magnetic latitude

1-D Electric Field Estimation

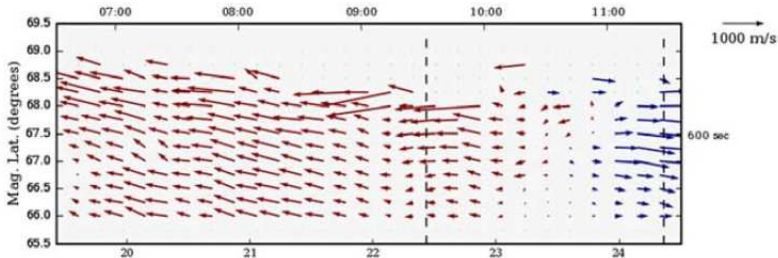
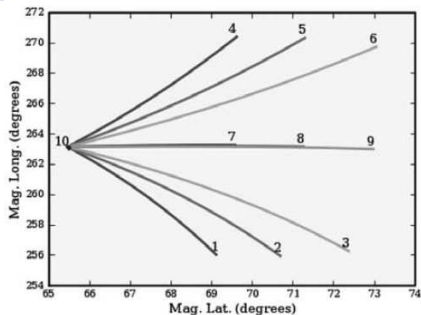
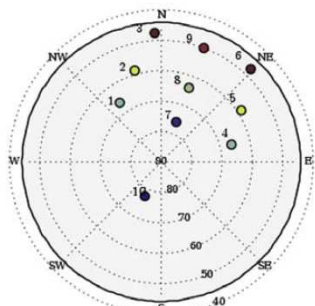

Interpretation of E-region Ion Velocities

Ion Momentum Equation:

$$0 = e(\mathbf{E} + \mathbf{u}_i \times \mathbf{B}) - m_i \nu_{in} (\mathbf{u}_i - \mathbf{u}_n)$$

Collisional Limit (D-region): $\mathbf{u}_i = \mathbf{u}_n$

Collisionless Limit (F-region): $\mathbf{u}_i = \frac{\mathbf{E} \times \mathbf{B}}{B^2}$

$$\text{E-region: } \mathbf{u}_i = \begin{pmatrix} \frac{1}{1+\kappa_i^2} & \frac{-\kappa_i}{1+\kappa_i^2} & 0 \\ \frac{\kappa_i}{1+\kappa_i^2} & \frac{1}{1+\kappa_i^2} & 0 \\ 0 & 0 & 1 \end{pmatrix} \left[\mathbf{u}_n + \frac{e}{m_i \nu_{in}} \mathbf{E} \right]$$

$$\kappa_i \equiv \frac{eB}{m_i \nu_{in}}$$

Joule II Rocket Results (Sangali et al. 2009)

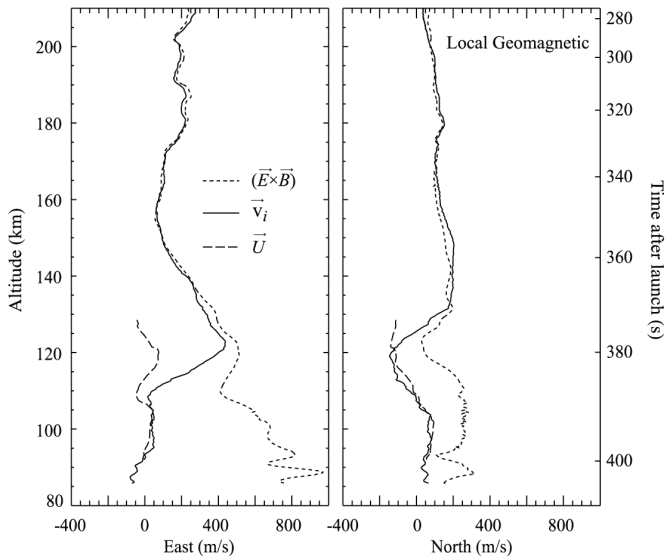

E-region Neutral Wind Estimation

- Estimate vector E-region ion velocities from E-region LOS velocity
- Estimate vector F-region electric fields from F-region LOS velocity
- Map electric fields from F-region to E-region along equipotential field lines
- Solve for \mathbf{u}_n

$$\mathbf{u}_n = \mathbf{u}_i - \frac{e}{m_i \nu_{in}} (\mathbf{E} + \mathbf{u}_i \times \mathbf{B})$$

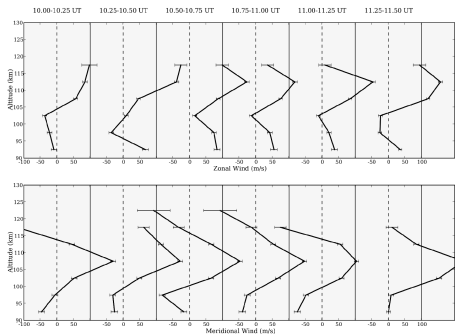

Heinselmann and Nicolls (2008) Radio Sci.

Mesospheric Vector Neutrals Winds

Line of Sight Velocities

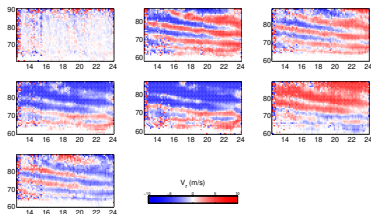

Fitted Horizontal Velocities

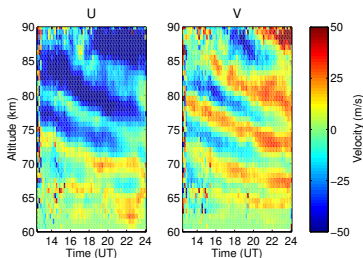

$$\begin{pmatrix} V_{r,1} \\ \vdots \\ V_{r,7} \end{pmatrix} = \begin{pmatrix} \cos(\theta_1) \sin(\phi_1) & \cos(\theta_1) \cos(\phi_1) & \sin(\theta_1) \\ \vdots & \vdots & \vdots \\ \cos(\theta_7) \sin(\phi_7) & \cos(\theta_7) \cos(\phi_7) & \sin(\theta_7) \end{pmatrix} \begin{pmatrix} u \\ v \\ w \end{pmatrix}$$

$$\mathbf{V}_r = \mathbf{D}\mathbf{U}$$

$$\mathbf{U} = (\mathbf{D}^T \Sigma_{V_r}^{-1} \mathbf{D})^{-1} \mathbf{D}^T \Sigma_{V_r}^{-1} \mathbf{V}_r$$

Derived Electrodynamical Parameters

- Conductivity

$$\sigma_P = N_e e^2 \left(\frac{\nu_{en}/m_e}{\nu_{en}^2 + \Omega_e^2} + \frac{\nu_{in}/m_i}{\nu_{in}^2 + \Omega_i^2} \right)$$

$$\sigma_H = N_e e^2 \left(\frac{\Omega_e/m_e}{\nu_{en}^2 + \Omega_e^2} - \frac{\Omega_i/m_i}{\nu_{in}^2 + \Omega_i^2} \right)$$

- Horizontal Currents

$$\mathbf{J} = \sigma_P (\mathbf{E} + \mathbf{u}_n \times \mathbf{B}) - \sigma_H \left[(\mathbf{E} + \mathbf{u}_n \times \mathbf{B}) \times \frac{\mathbf{B}}{B} \right]$$

- Joule Heating

$$Q_J = \mathbf{J} \cdot (\mathbf{E} + \mathbf{u}_n \times \mathbf{B})$$

$$= \sigma_P |\mathbf{E} + \mathbf{u}_n \times \mathbf{B}|^2$$

See Thayer (1998) *JGR* and Thayer and Semeter (2004) *JASTP*

Precipitation Characteristics from N_e Profile Inversion

- Input N_e profiles vs altitude (up-B beam)
- Estimate precipitating energy flux and characteristic energy
- Use a forward model of energetic electron transport, impact ionization, and recombination (e.g. GLOW).

Kaeppler et al. (2015) *JGR*.

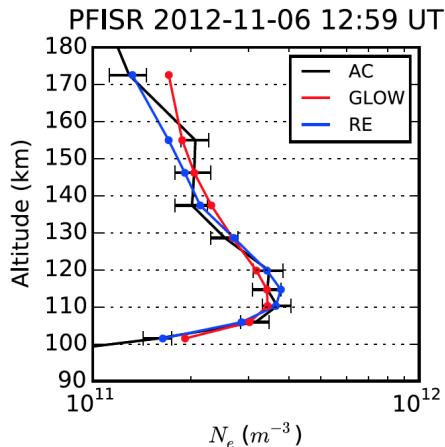

Best fit GLOW parameters:

$$Q = 7.3 \pm 0.8 \text{ mW/m}^2,$$

$$\mathcal{E}_0 = 5.0 \pm 0.2 \text{ keV}$$

Summary

Summary

Summary

We infer plasma parameters from processed voltage samples:

- send pulses, record voltage samples: zero mean Gaussian random variables
- estimate the autocorrelation function, mean value and variance of lag products
- gate ACFs so all lag products have same range extent
- construct a forward model: convolution ambiguity function with the FFT of theoretical ISR spectrum
- use non-linear weighted least-squares to find parameters that minimize the difference between the forward model and the estimated (“measured”) autocorrelation function