

Radar Physics

Anthea J. Coster

Outline

Electromagnetic spectrum

Radio waves and propagation

Radar fundamentals

Radar equation

Range resolution and pulsed radars

Doppler

Useful Fourier transforms

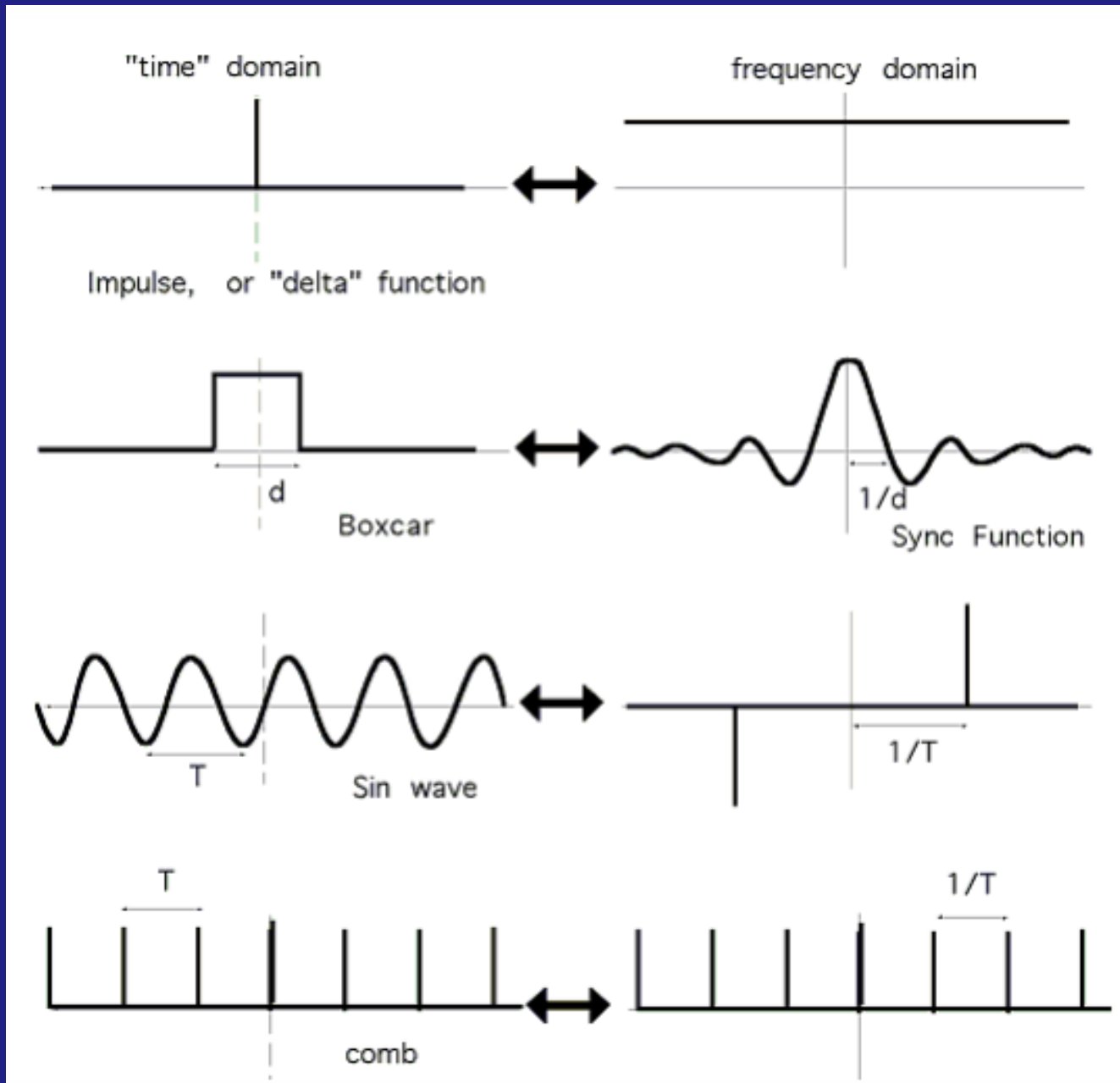

The Electromagnetic Spectrum

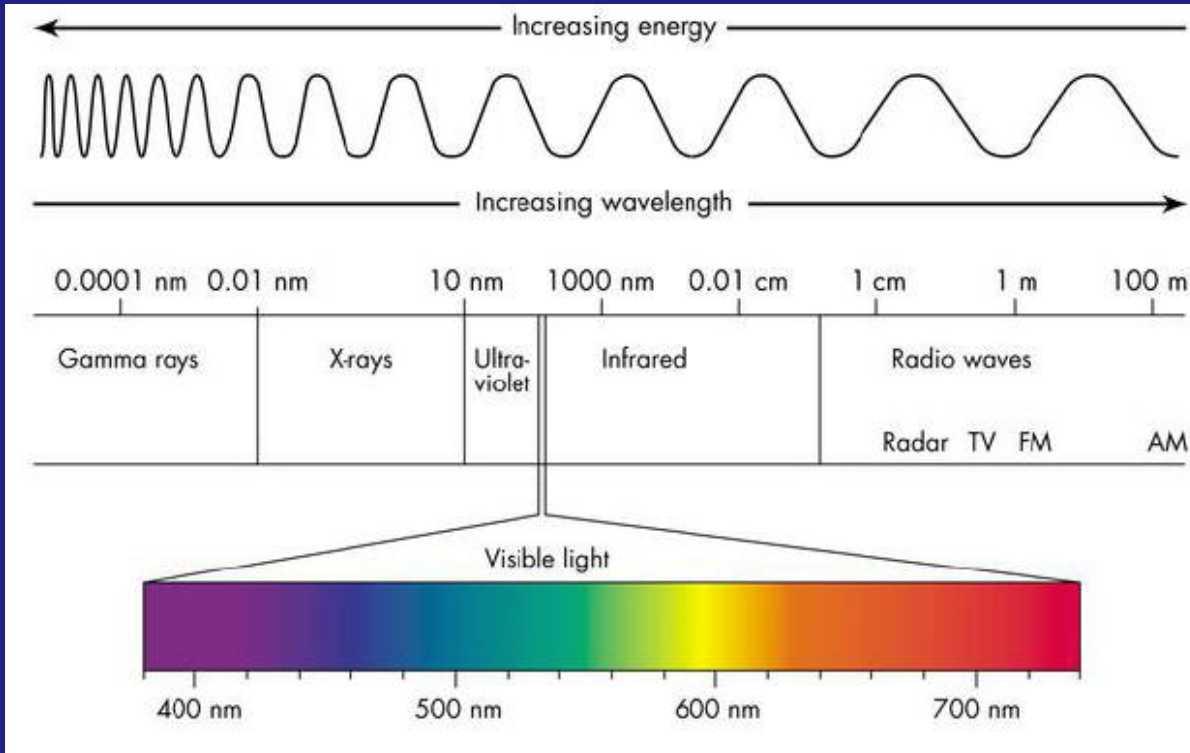

RADAR

Remote sensing using radio waves:

Just light we can't see without tools.

Atmospheric Windows to Electromagnetic Radiation

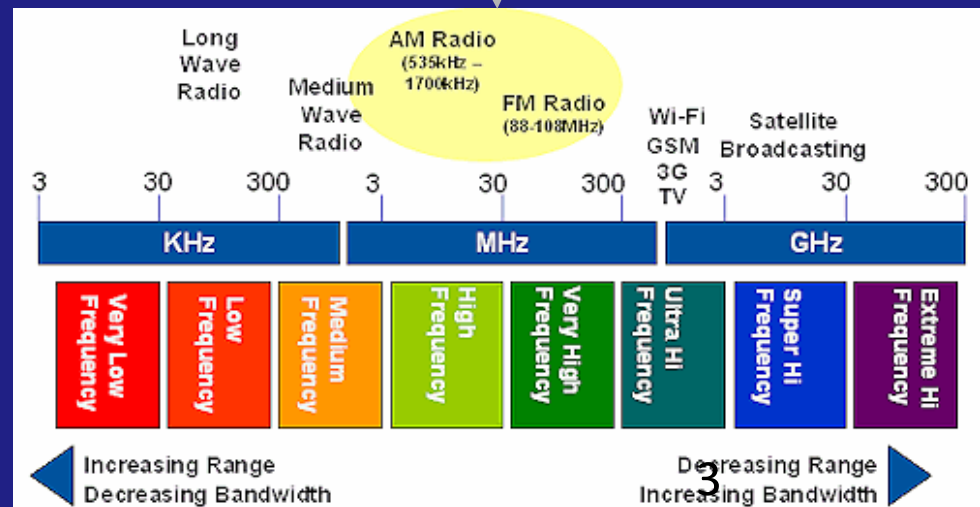
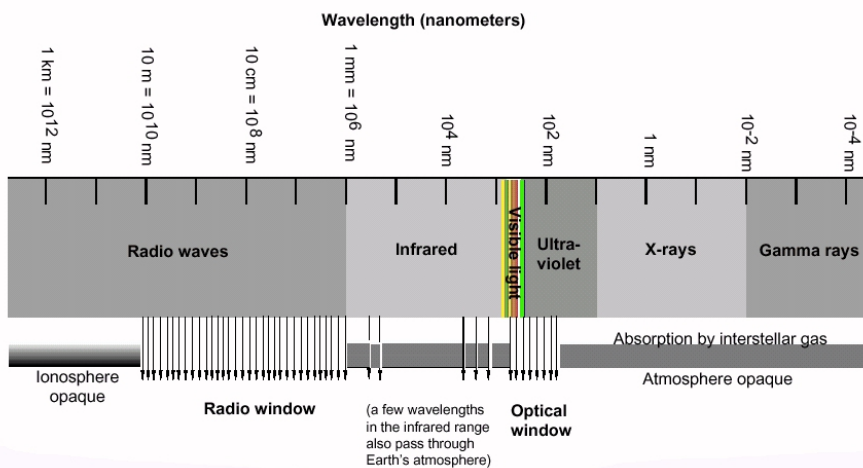

Properties of Waves

Relationship Between Frequency and Wavelength

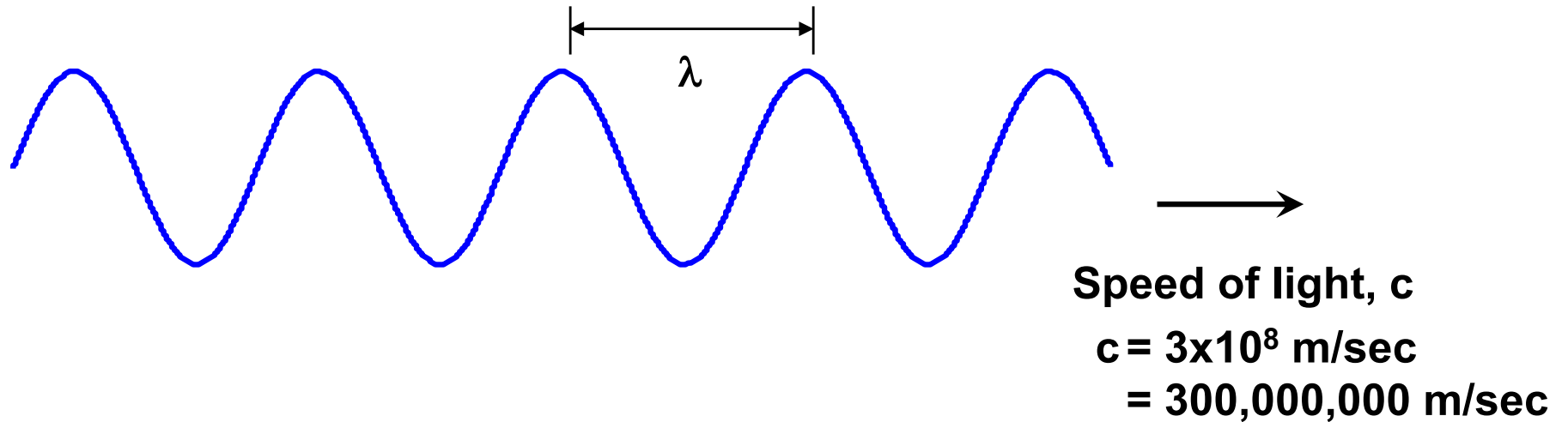

$$\text{Frequency (1/s)} = \frac{\text{Speed of light (m/s)}}{\text{Wavelength } \lambda \text{ (m)}}$$

Examples:

<u>Frequency</u>	<u>Wavelength</u>
100 MHz	3 m
1 GHz	30 cm
3 GHz	10 cm
10 GHz	3 cm

Properties of Waves

Phase and Amplitude

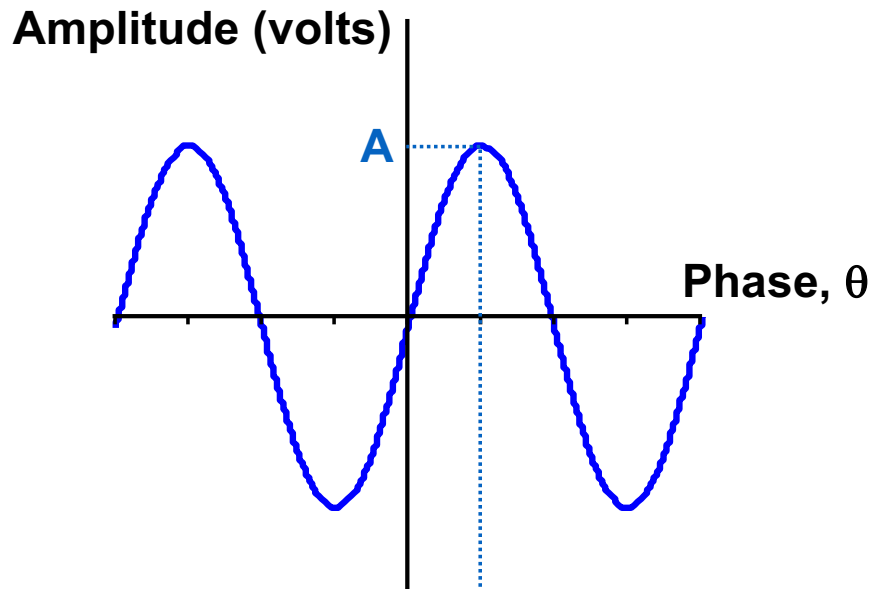

$$A \sin(\theta)$$

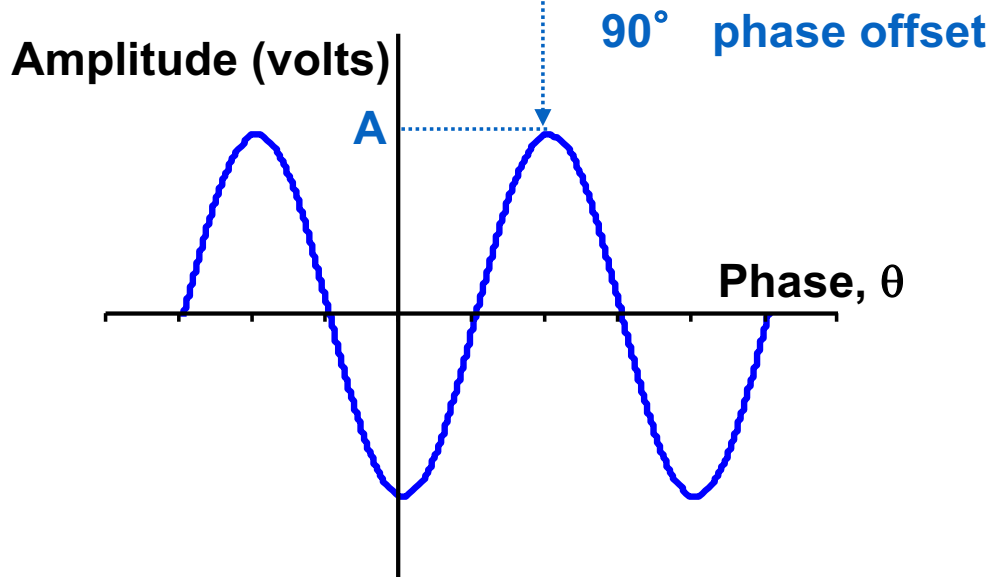

$$A \sin(\theta - 90^\circ)$$

Radio Waves

$$y(x, t) = A \cos(\omega t - kx + \phi_0)$$

Angular frequency

$$\omega = 2\pi f = 2\pi/T$$

Wavenumber

$$k = 2\pi/\lambda$$

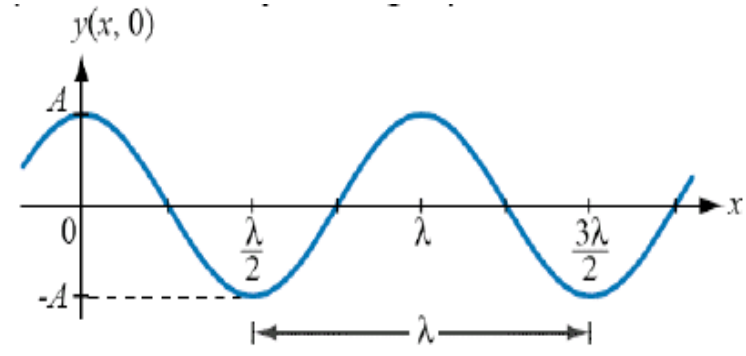
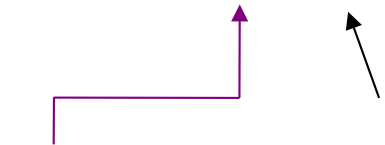

(a) $y(x, t)$ versus x at $t = 0$

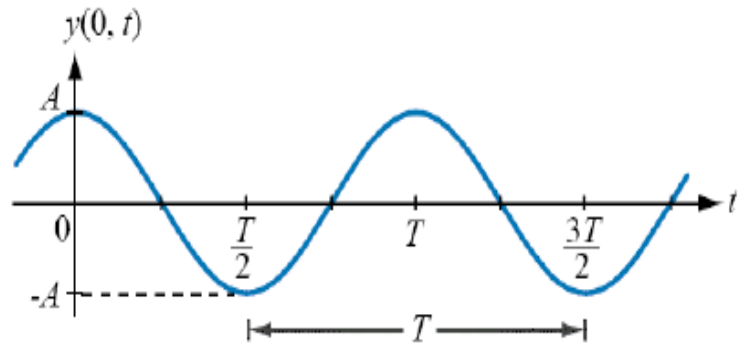

(b) $y(x, t)$ versus t at $x = 0$

Wave phase velocity

$$c = f\lambda = \omega/k = 3 \times 10^8 \text{ m/s}$$

$$\text{Frequency (1/s)} = \frac{\text{Speed of light (m/s)}}{\text{Wavelength } \lambda \text{ (m)}}$$

Properties of Waves

Constructive vs. Destructive Addition

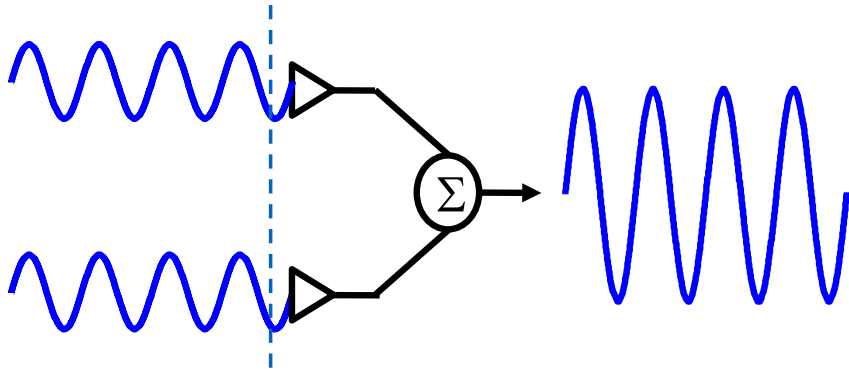

Constructive
(in phase)

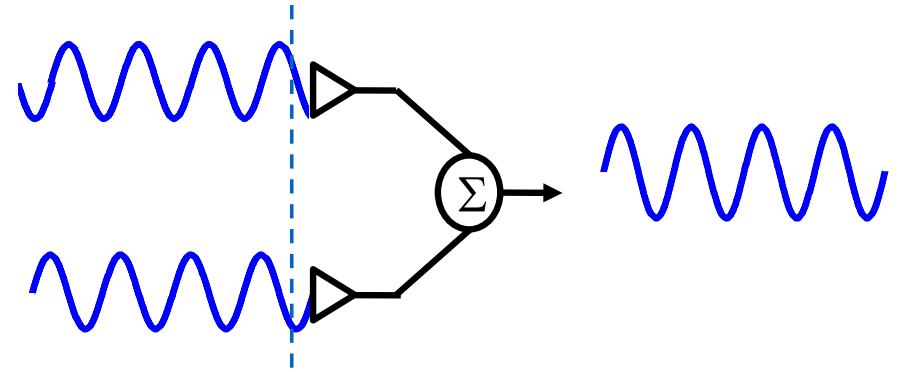

Partially Constructive
(somewhat out of phase)

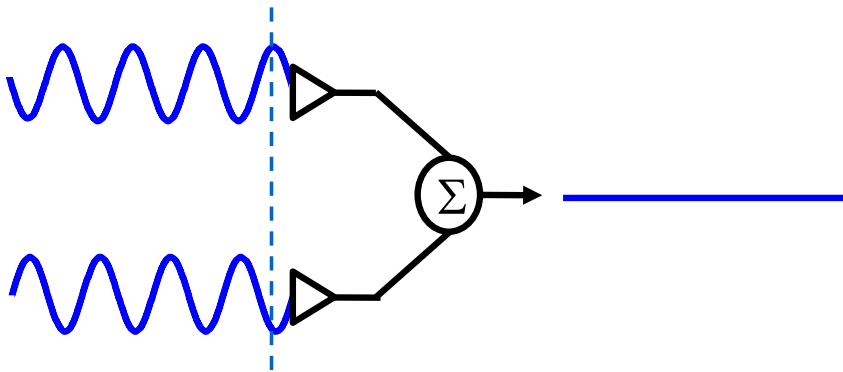

Destructive
(180° out of phase)

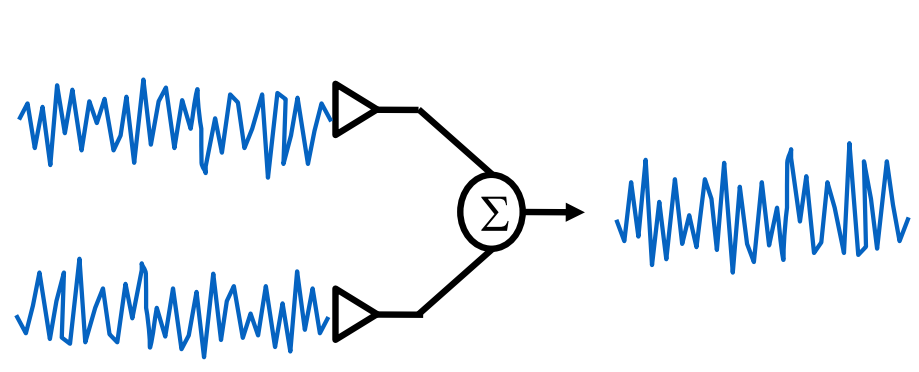

Non-coherent signals
(noise)

Phase Velocity, Group Velocity, Index of Refraction

$$v_p = \frac{\omega}{k}$$

$$v_g \equiv \frac{\partial \omega}{\partial k}$$

$$n = \frac{c}{v_p}$$

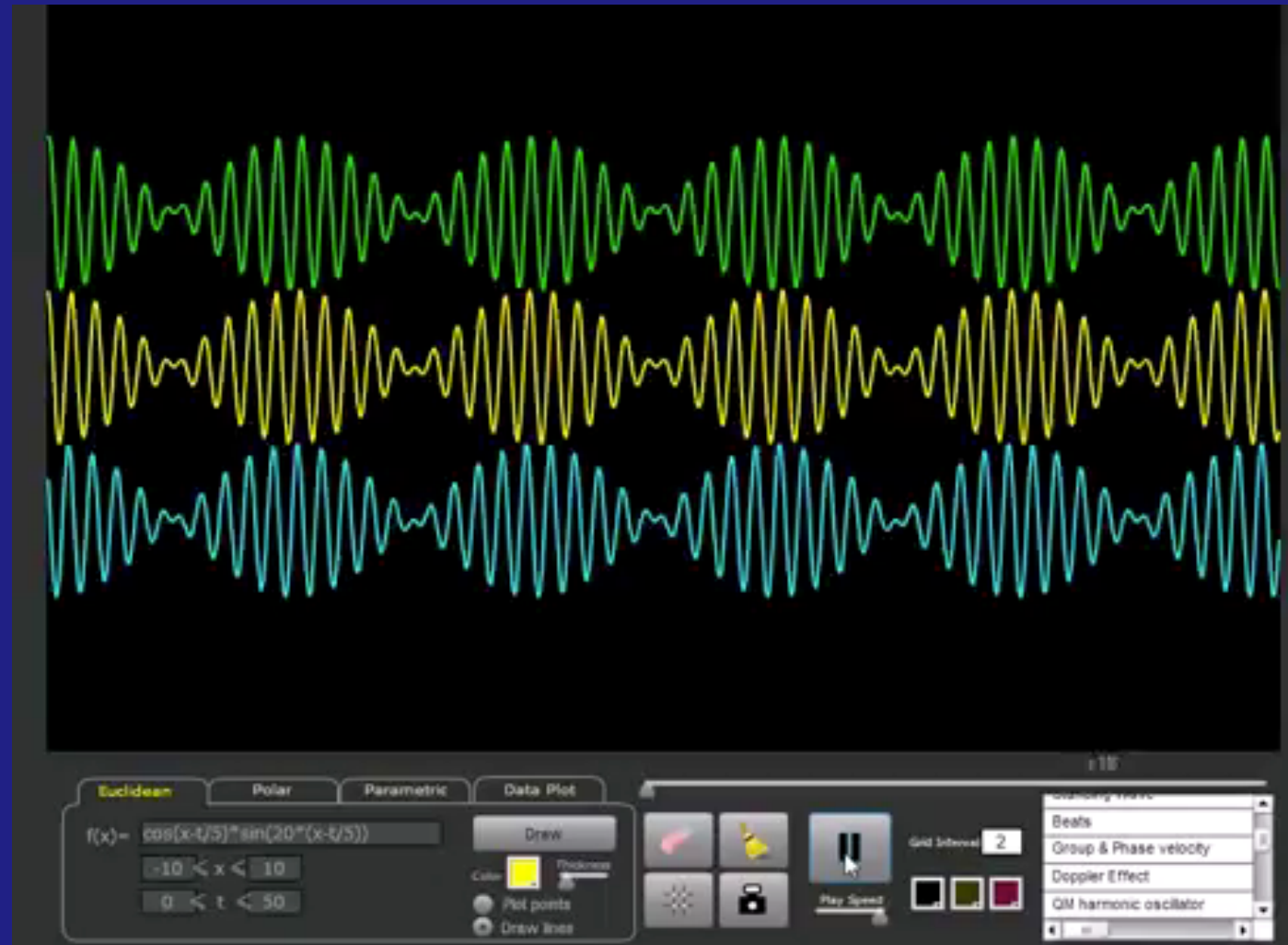

Refraction and Dispersion

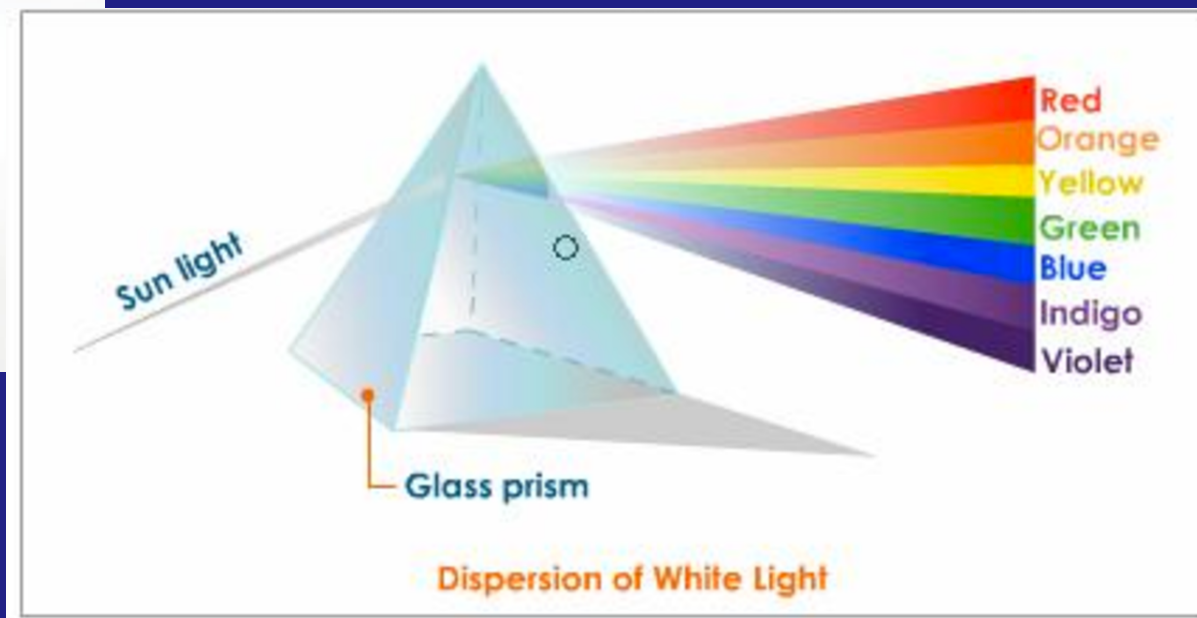
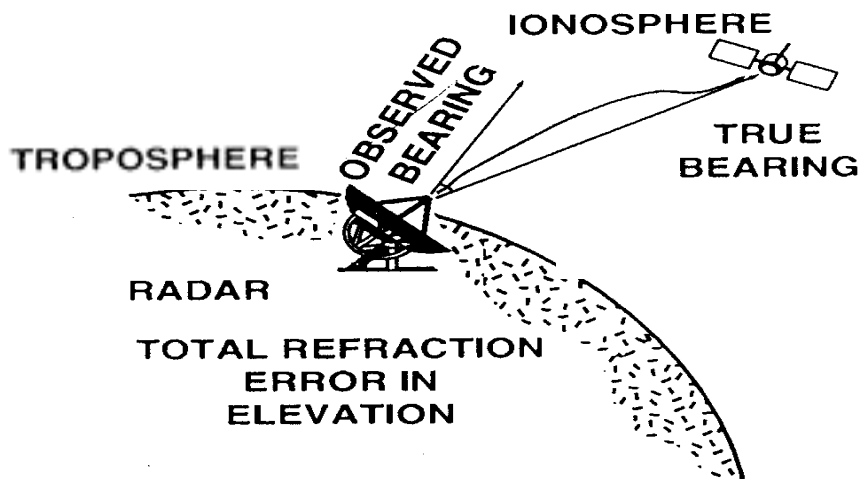
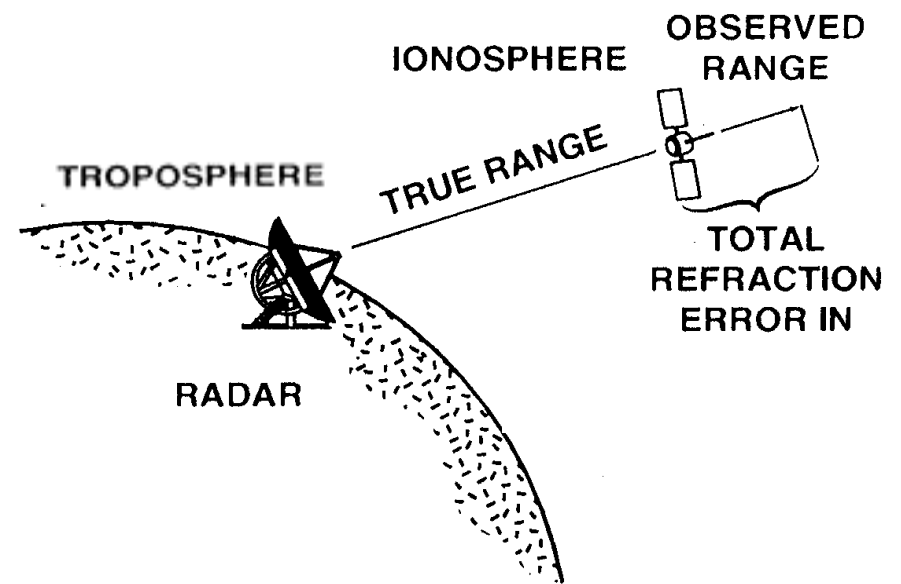

Illustration of Atmospheric Effects

Elevation Refraction



Range Delay



Index of Refraction $n = \frac{c}{v_p}$ in the Ionosphere

$$n^2 = 1 - \frac{X}{1 - iZ - \frac{\frac{1}{2}Y^2 \sin^2 \theta}{1 - X - iZ} \pm \frac{1}{1 - X - iZ} \left(\frac{1}{4}Y^4 \sin^4 \theta + Y^2 \cos^2 \theta (1 - X - iZ)^2 \right)^{1/2}}$$

n is the index of refraction

$$X = \frac{\omega_N^2}{\omega^2} \quad Y = \frac{\omega_H}{\omega} \quad Z = \frac{\nu}{\omega} \quad \omega_N = \left(\frac{Ne^2}{\epsilon_0 m_e} \right)^{1/2} \quad \omega_H = \frac{e|B|}{m_e}$$

ω = the angular frequency of the radar wave,

$Y_L = Y \cos \theta$, $Y_T = Y \sin \theta$,

θ = angle between the wave vector \bar{k} and \bar{B} ,

\bar{k} = wave vector of propagating radiation,

\bar{B} = geomagnetic field, N = electron density

e = electronic charge, m_e = electron mass, ν = electron collision frequency

and ϵ_0 = permittivity constant.

Radio Propagation in the Ionosphere

Index of Refraction (no **B** field)

$$n^2 = \frac{c^2 k^2}{\omega^2}$$

$$= 1 - \frac{\omega_p^2}{\omega^2}$$

Plasma Frequency

$$\omega_p^2 = \frac{n_0 e^2}{m \epsilon_0}$$

Phase Velocity

$$V_{ph} = \frac{\omega}{k}$$

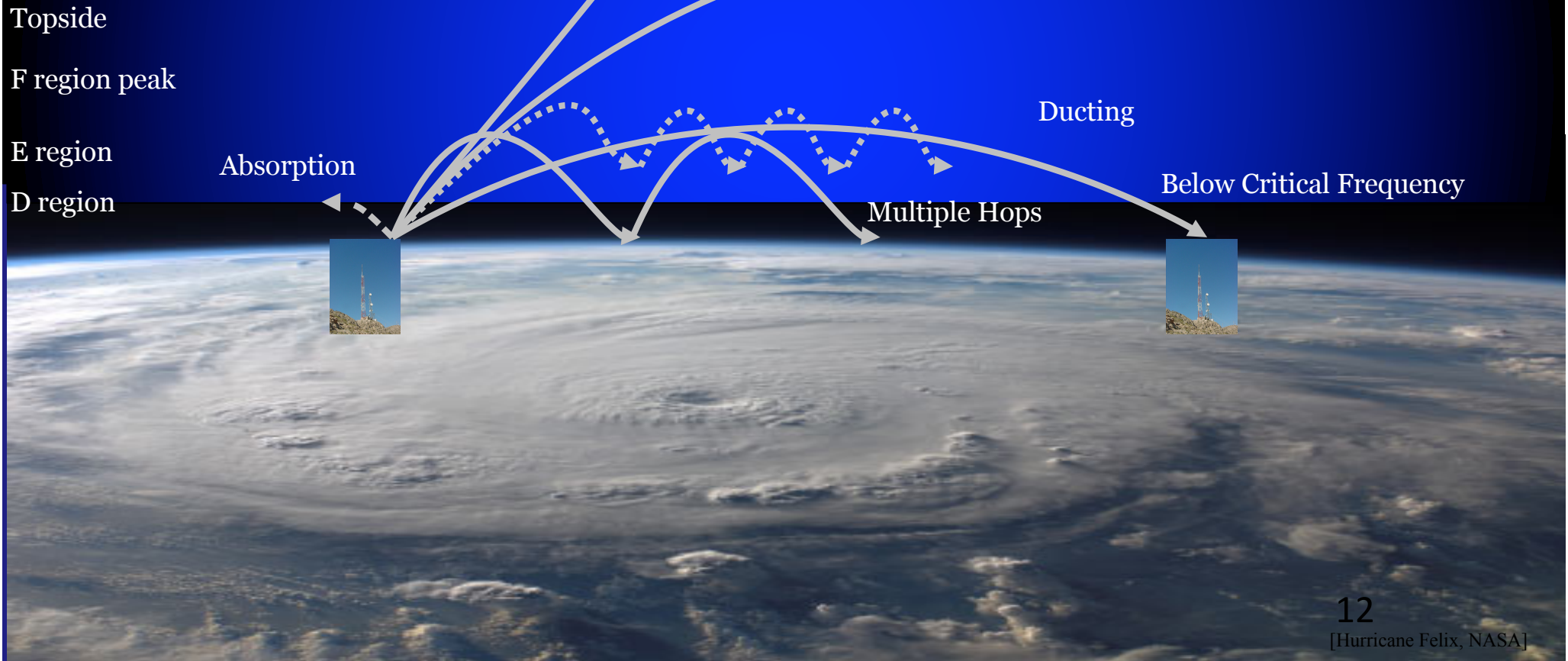

Dispersion relation: the concept

Key concept for wave behavior within a propagation medium.

Describes the relationship between SPATIAL frequency (wavelength) and TEMPORAL frequency.

Some wave modes relate wavelength to frequency **linearly**, but waves in most media have **nonlinear** relation between wavelength and frequency.

Linear dispersion example:

EM radiation propagation through free space
(wavelength / velocity = c)

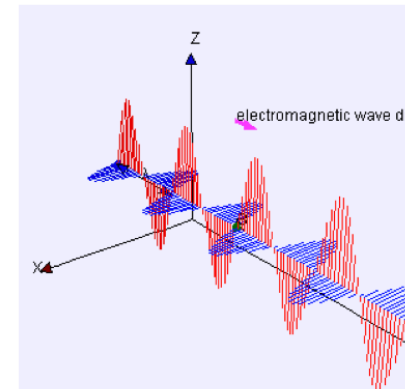

<http://weelookang.blogspot.com/2011/10/ejs-open-source-propagation-of.html>

Nonlinear dispersion example:

splitting of light through a prism
(effective speed of light depends on wavelength due to glass' non-unity index of refraction)



Wikipedia CC-3.0

Dispersion relation: the concept

Simple linear case: uniform phase velocity

$$\omega(k) = c k$$

Most propagation speeds depend nonlinearly on the wavelength and/or frequency.

NB: for a **nonlinear** dispersion relation, the pulse will typically spread in either spatial frequency or temporal frequency as a function of time.

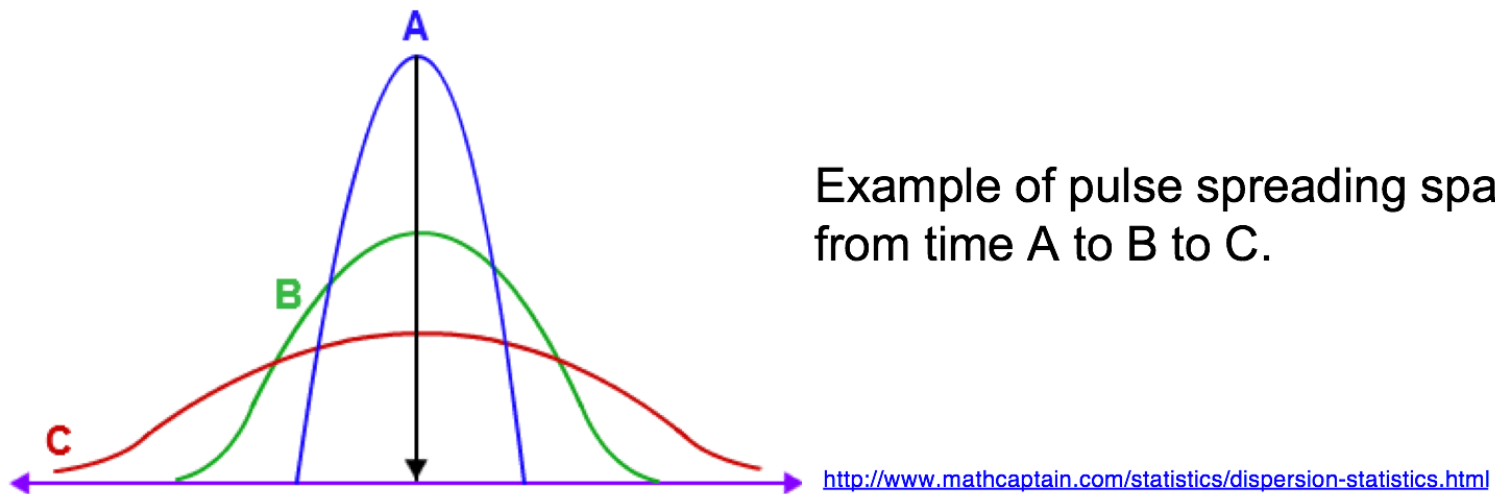

Example of pulse spreading spatially from time A to B to C.

Plasma dispersion relations

$$\epsilon(\omega, \vec{k}) = \text{function}(\omega^2/k^2)$$

Dielectric constant of the medium

Insert plasma dispersion relation here

$$\begin{aligned} n^2 &= \frac{c^2 k^2}{\omega^2} \\ &= 1 - \frac{\omega_p^2}{\omega^2} \end{aligned}$$

$$\epsilon(\omega, \vec{k}) = \epsilon_0 \left(1 - \frac{\omega_p^2}{\omega^2} \right)$$

$$v_p = \text{sqrt}(1/\epsilon\mu_0)$$

$$v_p = c/n$$

$$n = c/\text{sqrt}(1/\epsilon\mu_0)$$

$$n = c*\text{sqrt}(\epsilon\mu_0)$$

$$c = 1/\text{sqrt}(\epsilon_0\mu_0)$$

$$n = \text{sqrt}(\epsilon/\epsilon_0)$$

Polarization

Electromagnetic Wave

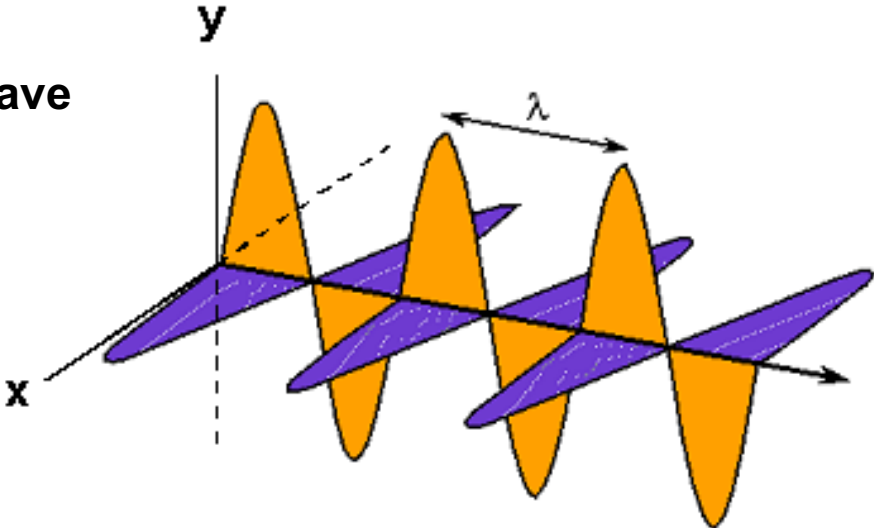

- Electric Field
- Magnetic Field

Vertical Polarization

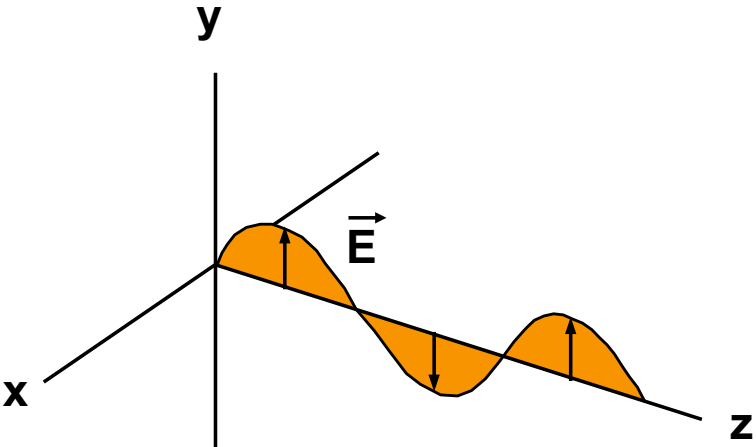

Horizontal Polarization

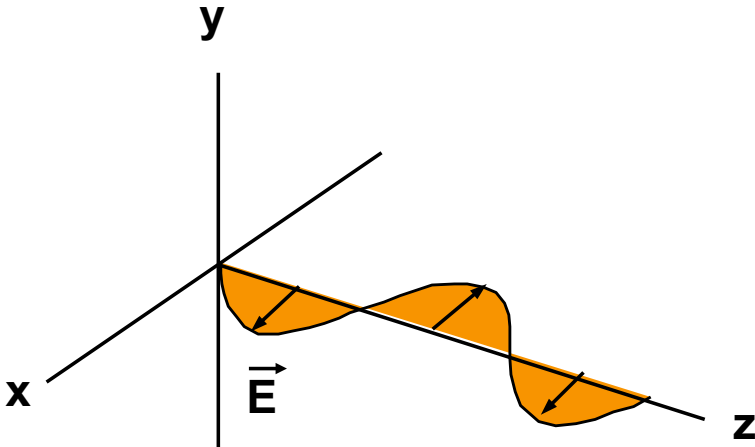

TEM Waves: *Transverse electromagnetic (TEM) modes* neither electric nor magnetic field in the direction of propagation

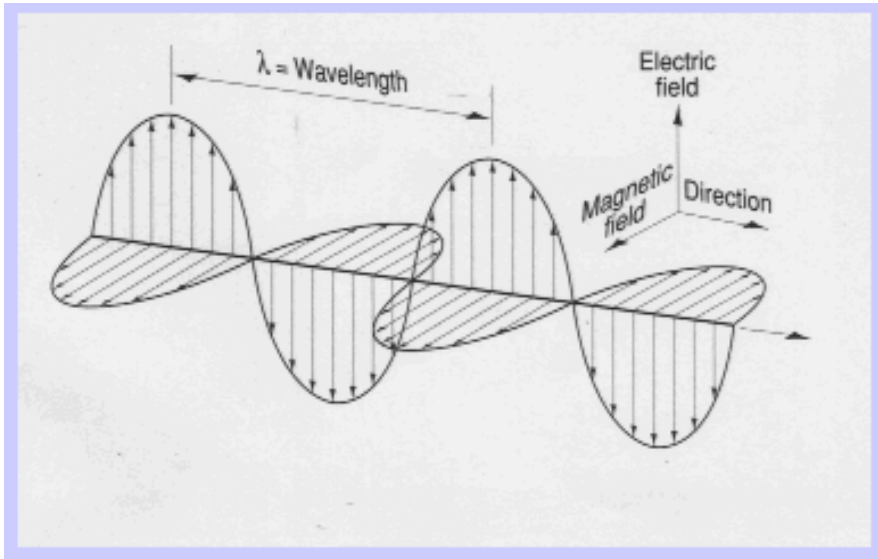

Electromagnetic waves in free space propagate in TEM mode

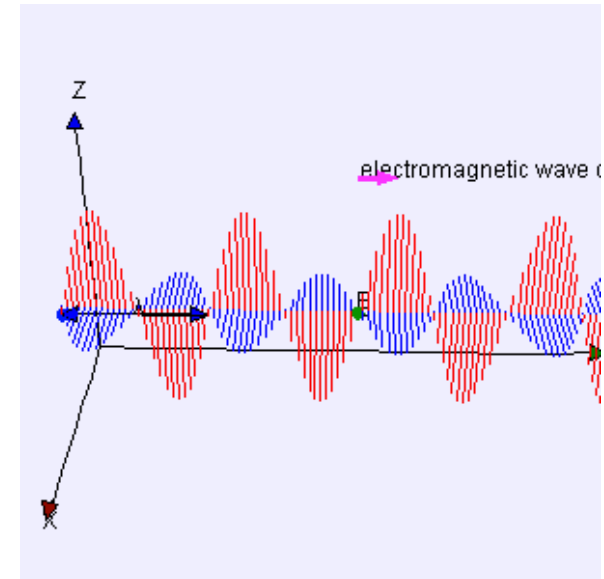
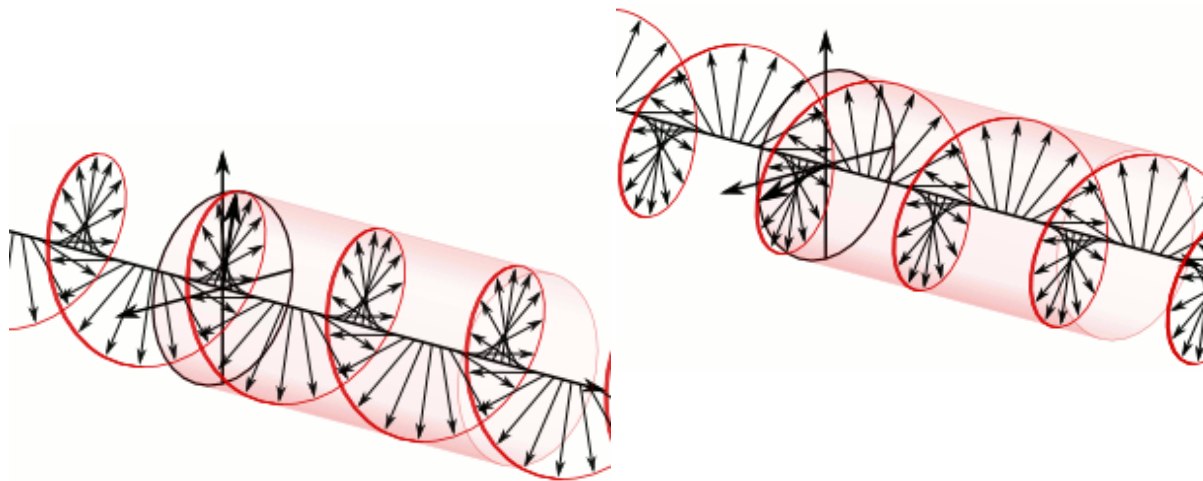

Outline - Radar Basics

- Electromagnetic spectrum
- Radio waves and propagation
- ➔ Radar fundamentals
 - Radar equation
 - Range resolution and pulsed radars
- Doppler

RADAR

Radio Detection And Ranging

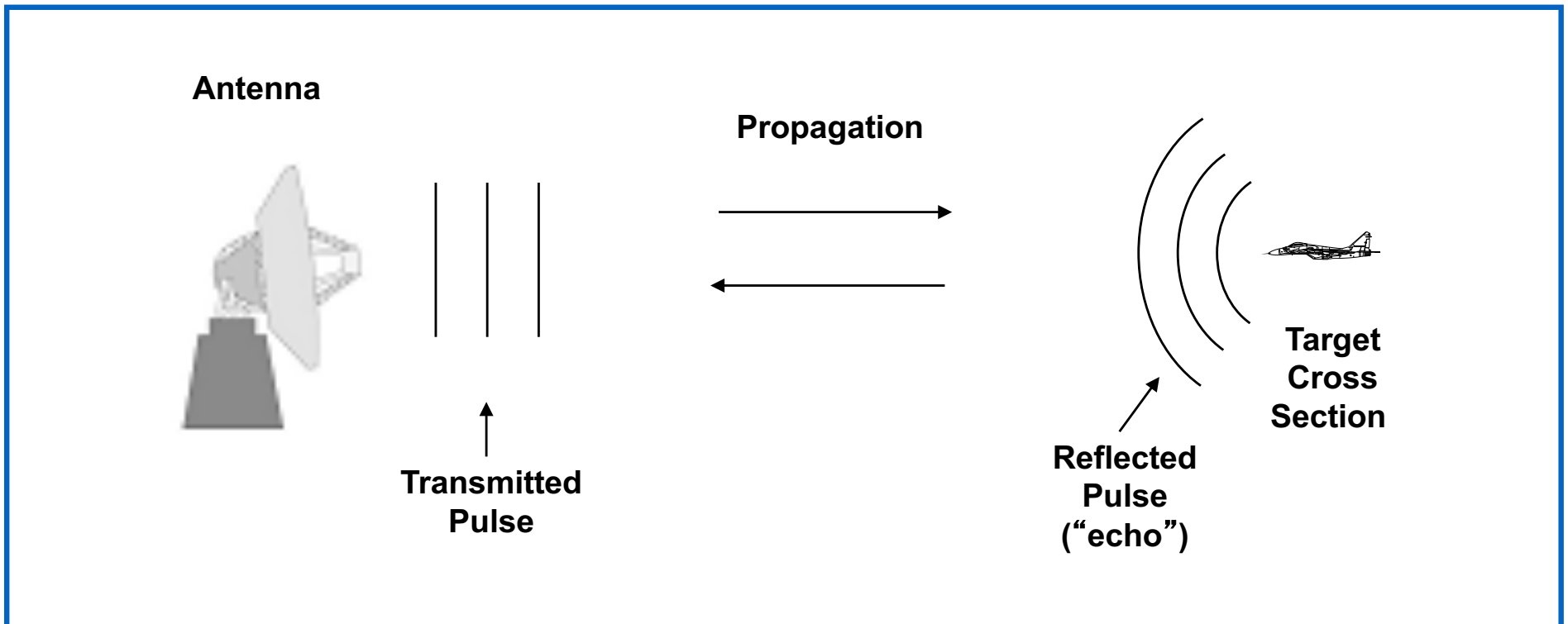

Radar observables:

- Target range
- Target angles (azimuth & elevation)
- Target size (radar cross section)
- Target speed (Doppler)
- Target features (imaging)

Radar Block Diagram

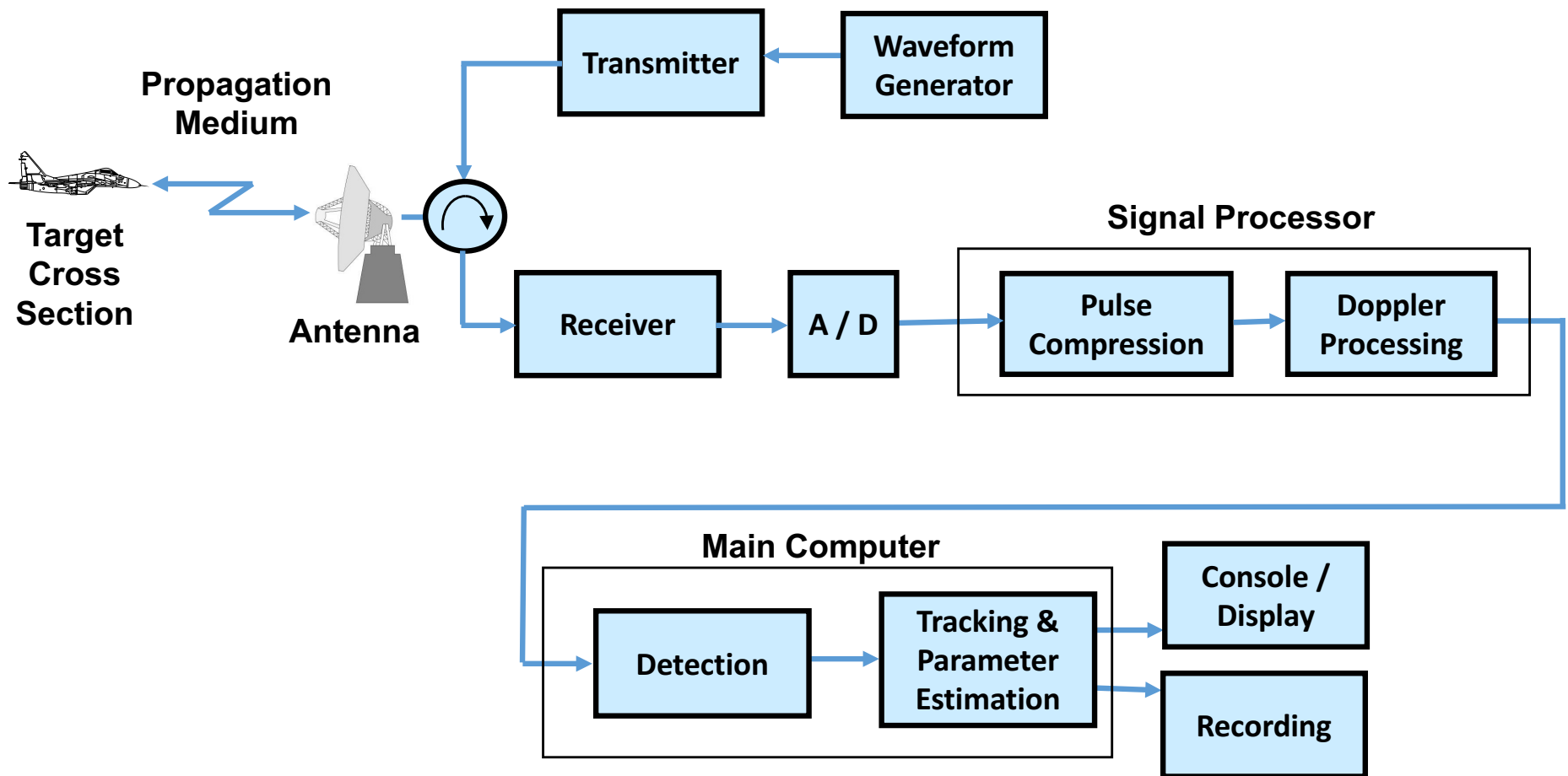

Radar Range Equation

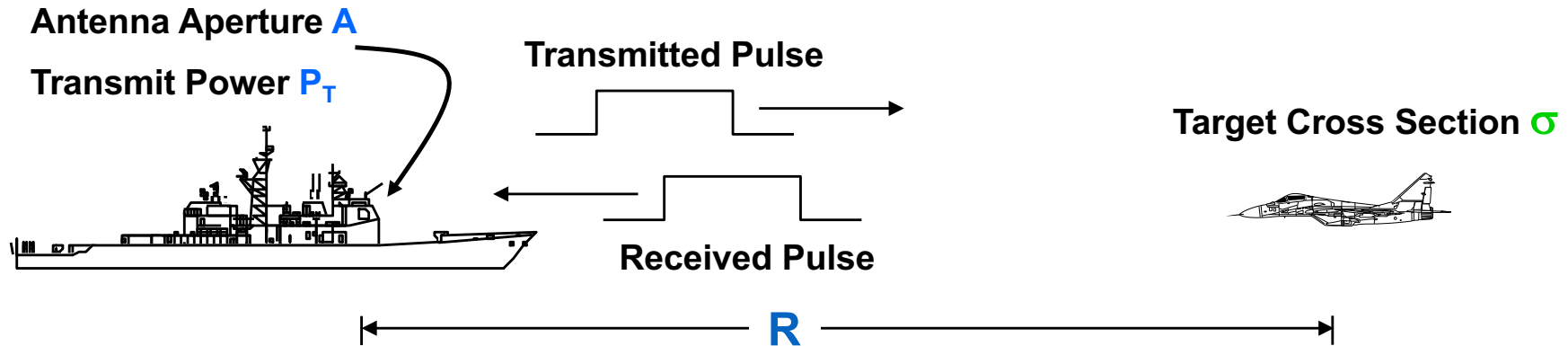

Received Signal Energy	=	Transmit Power	Transmit Gain	Spread Factor	Losses	Target RCS	Spread Factor	Receive Aperture	Dwell Time
		$[P_T]$	$\left[\frac{4\pi A}{\lambda^2} \right]$	$\left[\frac{1}{4\pi R^2} \right]$	$\left[\frac{1}{L} \right]$	$[\sigma]$	$\left[\frac{1}{4\pi R^2} \right]$	$[A]$	$[\tau]$

Antennas

Most basic form of antennas – a wire element with a time varying current flowing in it

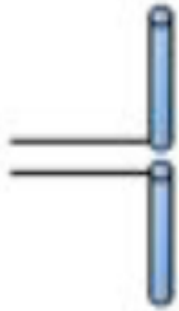

Dipole antenna

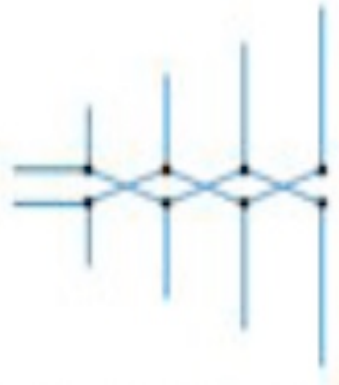

Log periodic

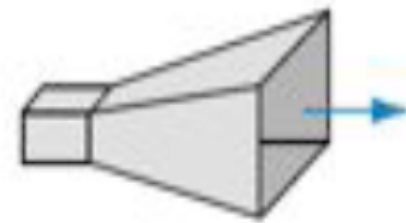

Horn antenna

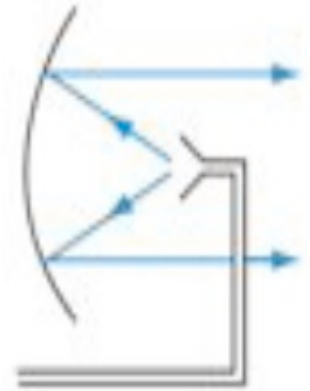

Parabolic dish
Reflector antenna

Examples of Antennas

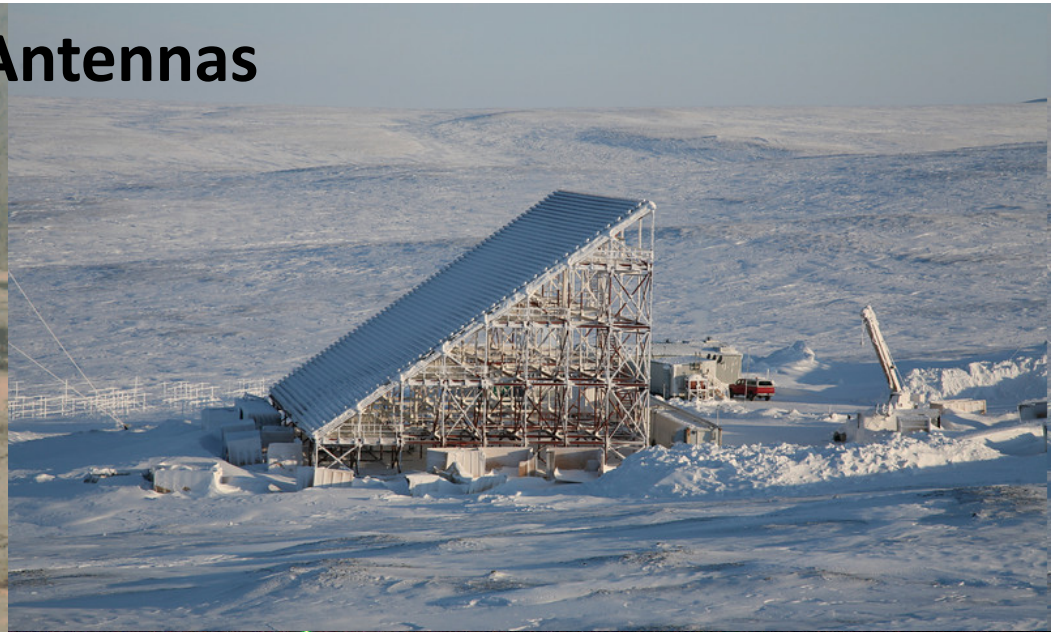



Antennas

Four primary functions of an antenna for radar applications:

- Impedance transformation (free-space intrinsic impedance to transmission-line characteristic impedance)
- Propagation-mode adapter (free-space fields to guided waves)
- Spatial filter (radiation pattern – direction-dependent sensitivity)
- Polarization filter (polarization-dependent sensitivity)

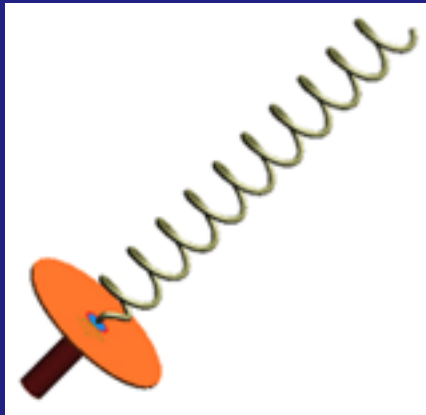

Helical antenna

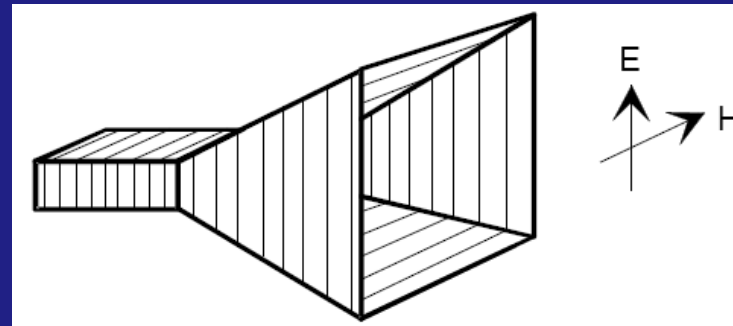

Horn antenna

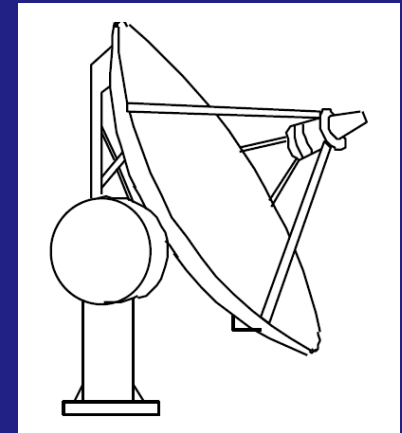

Parabolic reflector antenna

Impedance transformer

- Intrinsic impedance of free-space, $\eta_0 \equiv E/H$ is

$$\eta_0 = \sqrt{\mu_0/\epsilon_0} = 120 \pi \cong 376.7 \Omega$$

- Characteristic impedance of transmission line,
 $Z_0 = V/I$
- A typical value for Z_0 is 50Ω .
- Clearly there is an impedance mismatch that must be addressed by the antenna.

Propagation-mode adapter

During both transmission and receive operations, the antenna must provide the transition between these two propagation modes.

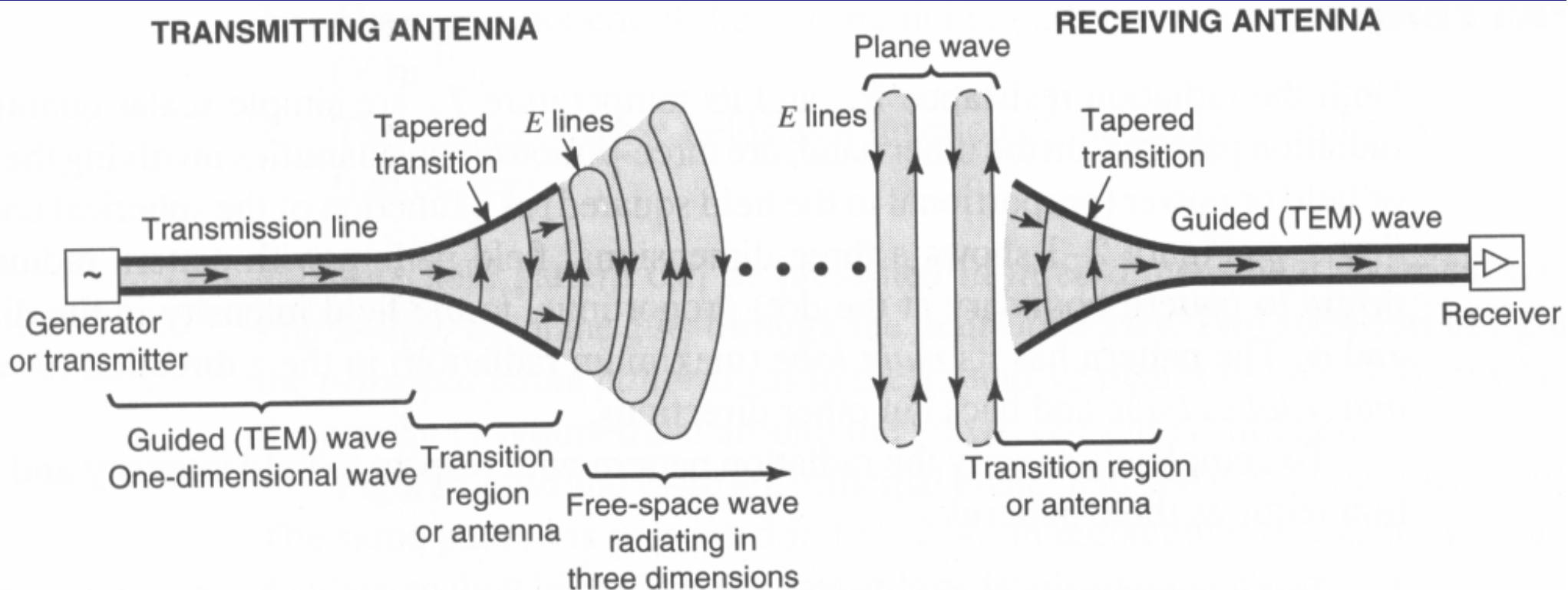

Spatial filter

Antennas have the property of being more sensitive in one direction than in another, which provides the ability to spatially filter signals from its environment.



Directive antenna.

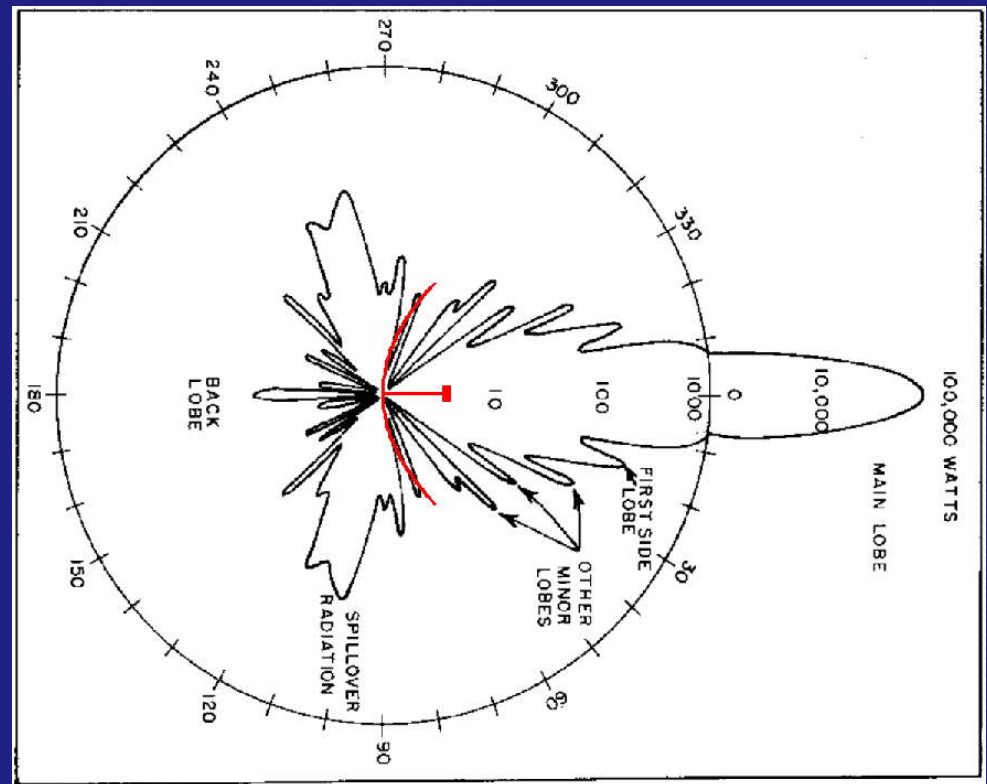

Radiation pattern of directive antenna.

Radiation pattern – antenna gain

Isotropic antenna

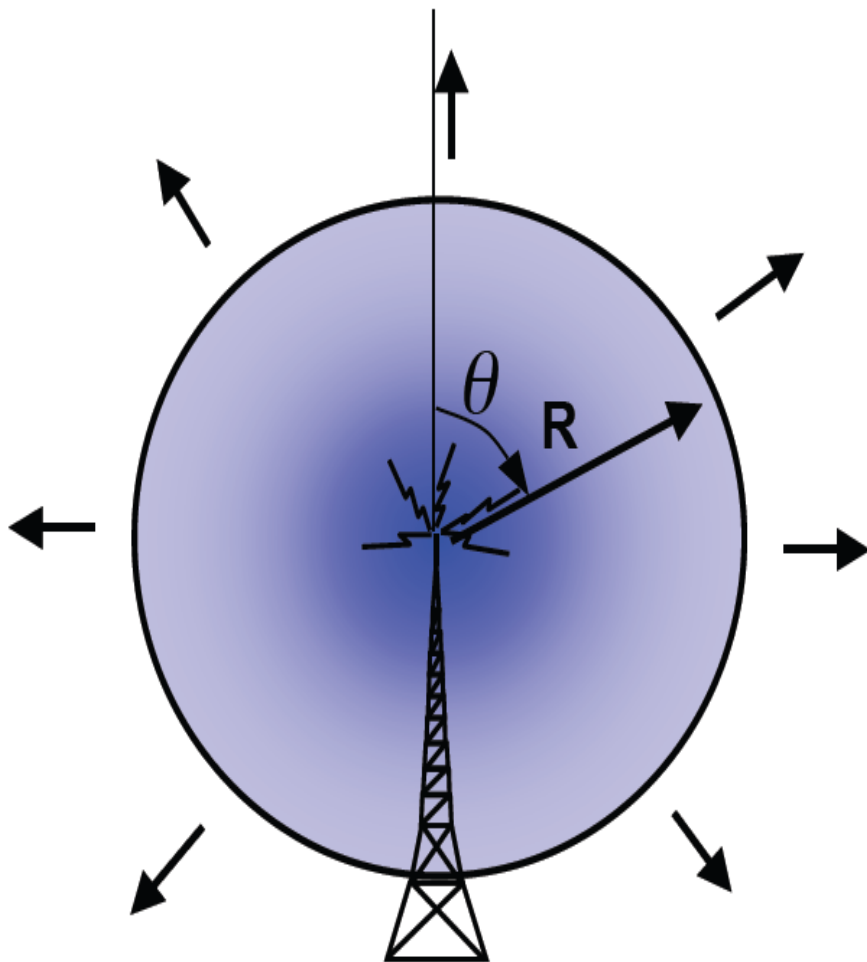

Directional antenna

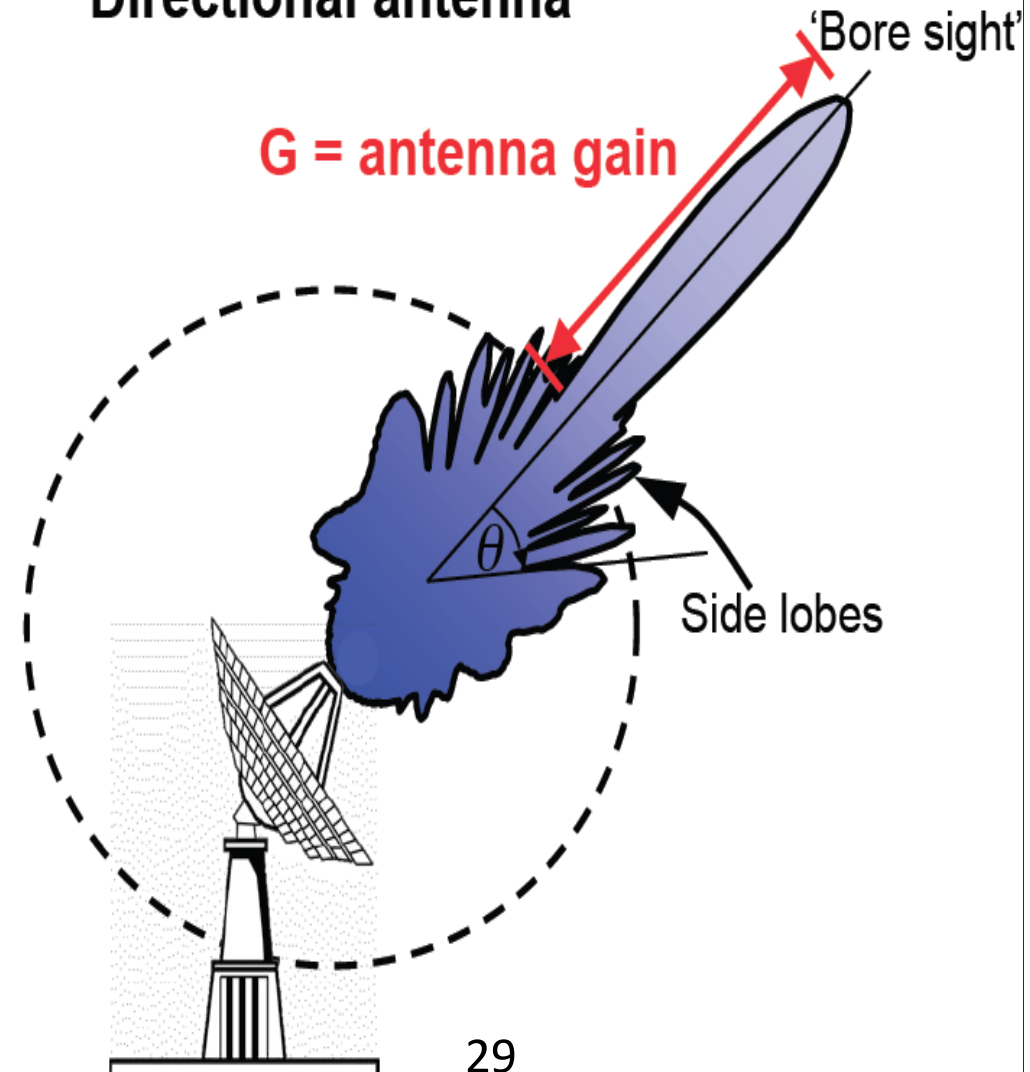

Polarization filter

Antennas have the property of being more sensitive to one polarization than another. This provides the ability to filter signals based on its polarization.

Example: Satellite tracking receive on both right-circular and left-circular

Propagation medium – losses

Radio waves are affected by the medium they propagate in. Effects dependent on the refractive index of the medium and wave frequency

Radio waves are also reflected off of the surface

- Atmospheric attenuation
- Reflection off of earth's surface
- Over-the-horizon diffraction
- Atmospheric refraction

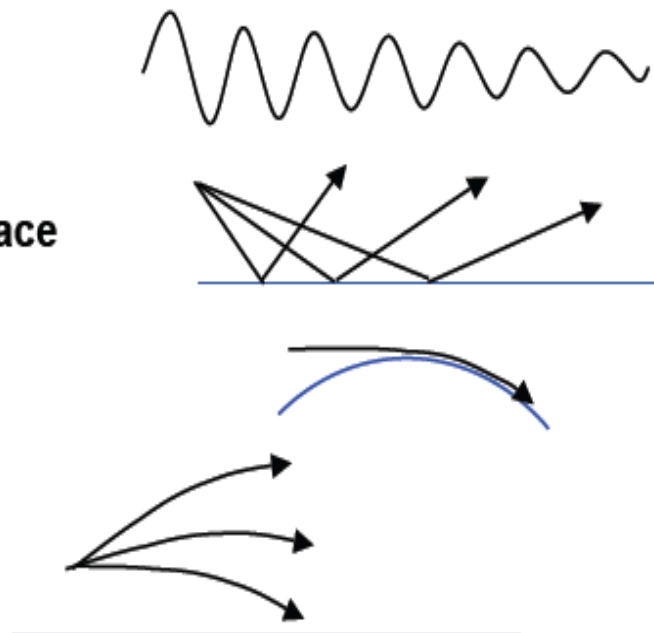

Attenuation usually measured in dB

$$\text{SNR dB} = 10 \log_{10} \frac{\text{signal power}}{\text{noise power}}$$

<u>dB value</u>	<u>times by</u>
+30 dB	1000
+20 dB	100
+3 dB	2
-10 dB	0.1
-20 dB	0.01

Radar equation

$$\begin{array}{cccccccc} & \text{Transmit} & \text{Transmit} & \text{Spread} & \text{Losses} & \text{Target} & \text{Spread} & \text{Receive} & \text{Dwell} \\ & \text{Power} & \text{Gain} & \text{Factor} & & \text{RCS} & \text{Factor} & \text{Aperture} & \text{Time} \\ \text{Received Signal} & & & & & & & & \\ \text{Energy} & = & [P_T] & \left[\frac{4\pi A}{\lambda^2} \right] & \left[\frac{1}{4\pi R^2} \right] & \left[\frac{1}{L} \right] & [\sigma] & \left[\frac{1}{4\pi R^2} \right] & [A] & [\tau] \end{array}$$

Radar cross section tells us about the target properties

It is the effective target cross section as seen by the radar

Radar Cross Section (RCS)

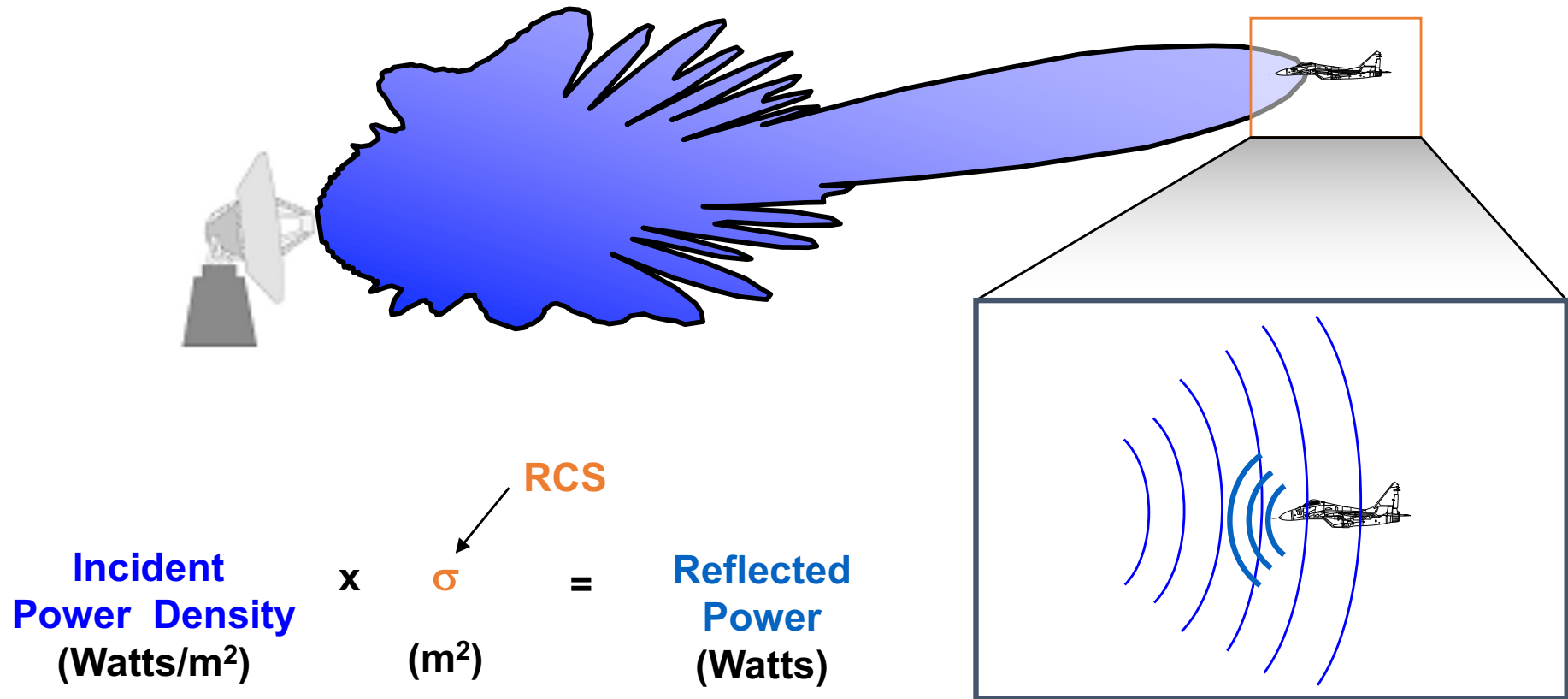

Radar Cross Section (RCS, or σ) is the effective cross-sectional area of the target as seen by the radar

measured in m², or dBm²

Hard targets vs. Soft targets

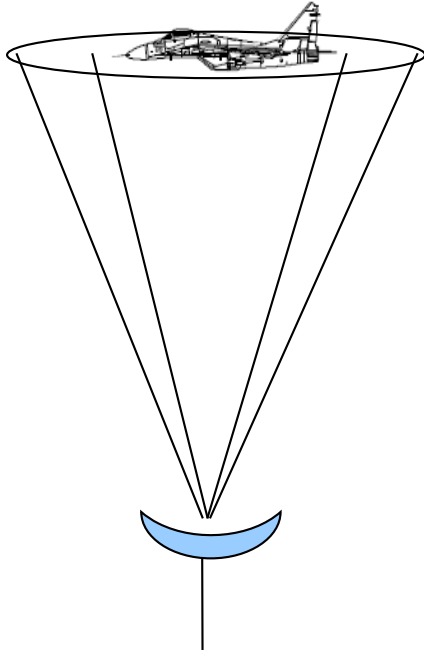

vs.

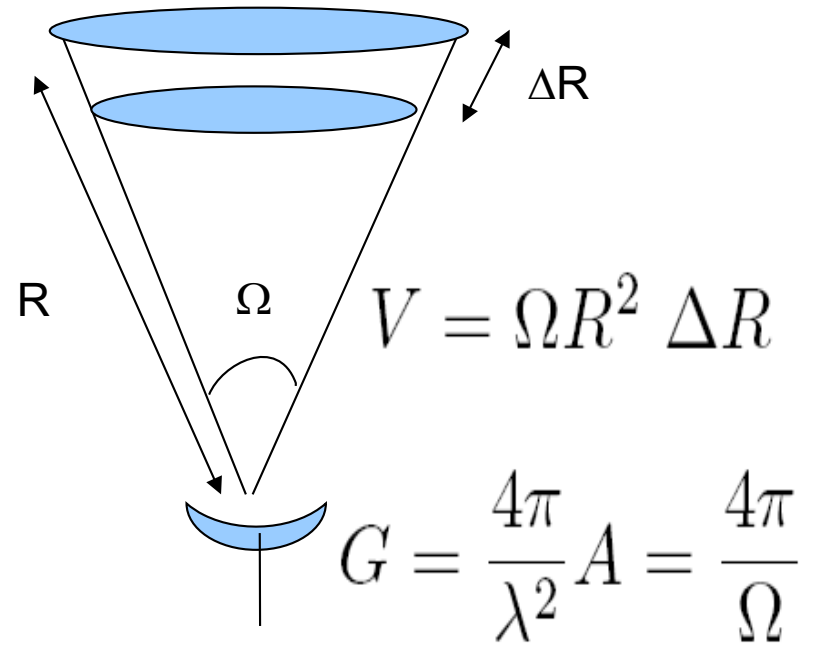

$$P_r = \frac{P_t G^2 \lambda^2 \sigma}{(4\pi)^3 R^4}$$



$$P_r = \frac{P_t A \sigma_v \Delta R}{4\pi R^2}$$



Volume scattering - Ionosphere

- Volume scattering cross section σ_v has area/volume units
- Signal is proportional to range resolution
- What about the ionosphere ?
 - Cross section of a single electron = 10^{-28} m^2
 - Cross section of a bunch of electrons in a 10 km^3 volume in the ionosphere assuming electron density = $10^{12} /\text{m}^3$, is $10^{10} \times 10^{12} \times 10^{-28} = 10^{-6} \text{ m}^2$!!)
 - **CAN be measured by an incoherent scatter radar.**

Radar Range Equation

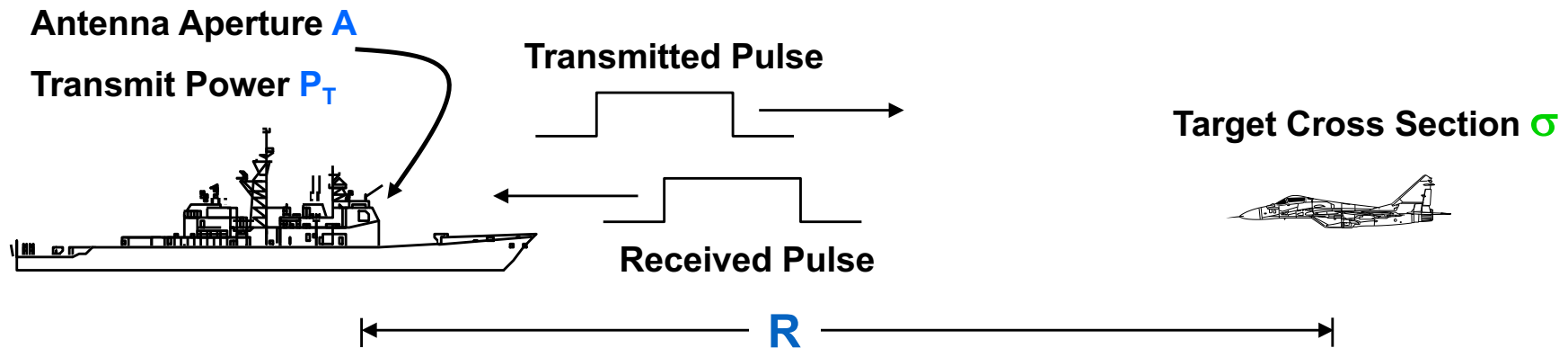

Received Signal Energy	=	Transmit Power	Transmit Gain	Spread Factor	Losses	Target RCS	Spread Factor	Receive Aperture	Dwell Time
		$[P_T]$	$\left[\frac{4\pi A}{\lambda^2} \right]$	$\left[\frac{1}{4\pi R^2} \right]$	$\left[\frac{1}{L} \right]$	$[\sigma]$	$\left[\frac{1}{4\pi R^2} \right]$	$[A]$	$[\tau]$

What the radar transmits: Pulses and waves

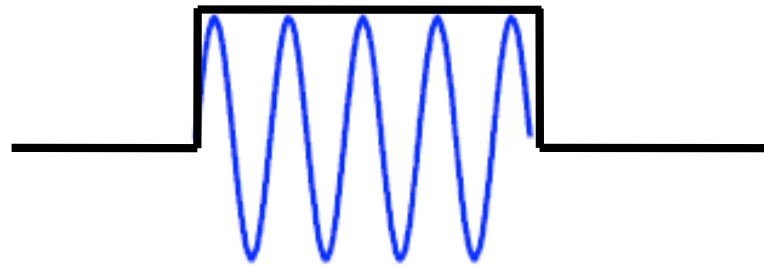

Cycles in a pulse.

PFISR frequency = 449 MHz
Long pulse length = 480 μ s
of cycles = 215520 !

Radar waveforms
modulate the waves
with on-off sequence

Pulsed Radar

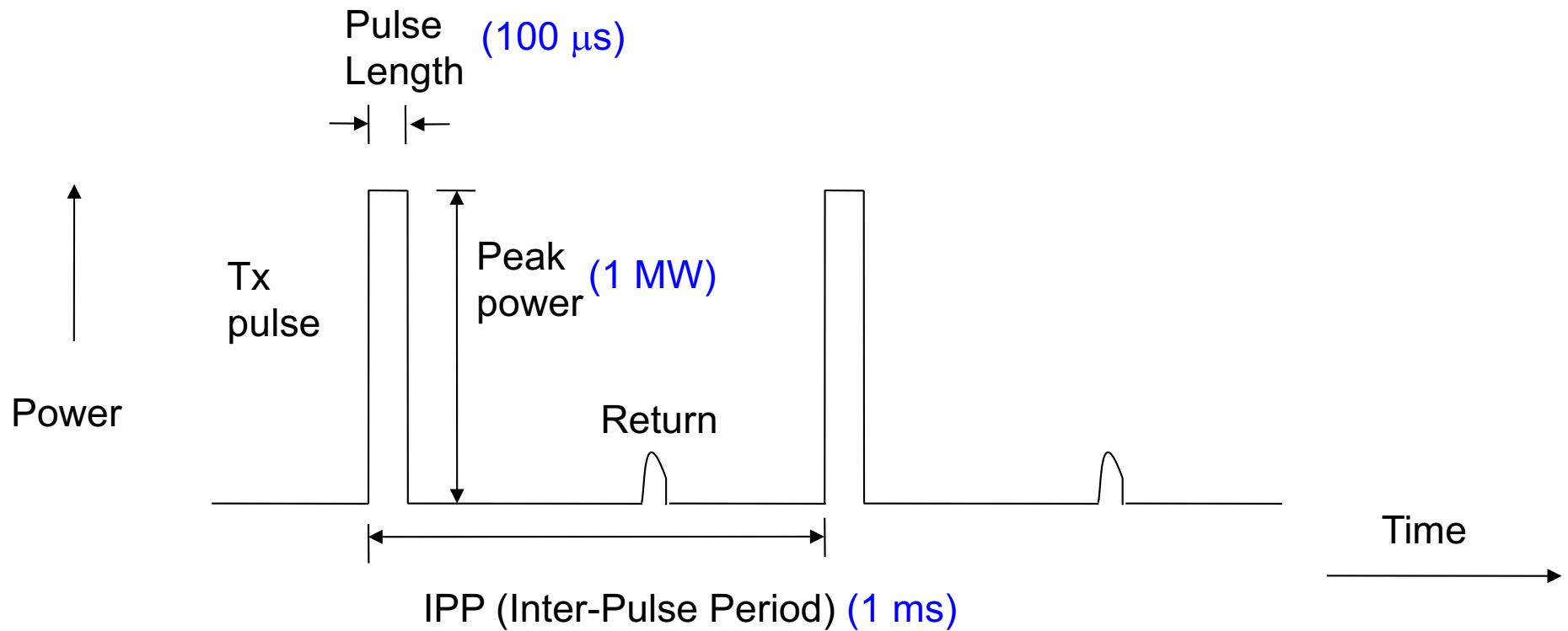

Duty cycle = Pulse Length/IPP (10%)

Average power = Peak power x Duty cycle (100 kW)

PRF (Pulse Repetition Frequency) = 1/IPP (1 kHz)

Duty cycle for a CW (continuous wave) radar 100%

Range Resolution

Range resolution is set by pulse length

Pulse length = τ_p , Range resolution = $c\tau_p/2$ for a single target.

Maximum unambiguous range

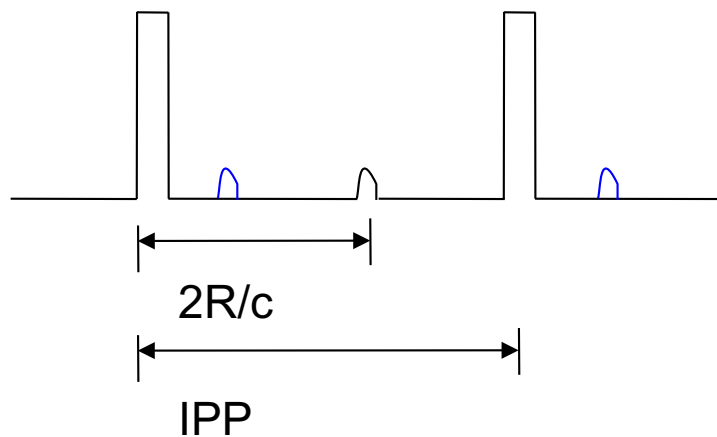

$$\text{MUR} = c \cdot \text{IPP} / 2$$

Pulse duration vs. Range resolution

Pulse Duration	Range Resolution
0.1 nsec	1.5 cm
1.0 nsec	15 cm
10 nsec	1.5 m
100 nsec	15 m
1 μ sec	150 m
10 μ sec	1.5 km
100 μ sec	15 km
1 msec	150 km

What is a typical F region ISR pulselength?

Radar Waveforms

What do radars transmit?

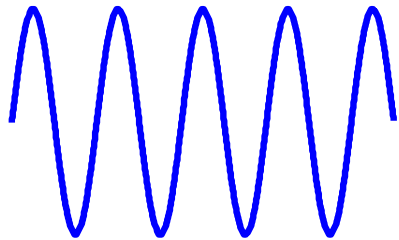

Waves?



or Pulses?

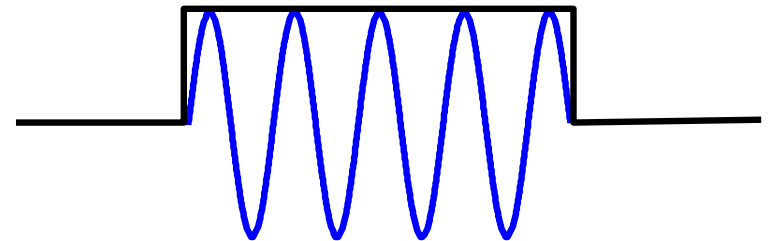

Waves, modulated
by "on-off" action of
pulse envelope

Radar Waveforms (cont' d.)

Pulse at single frequency

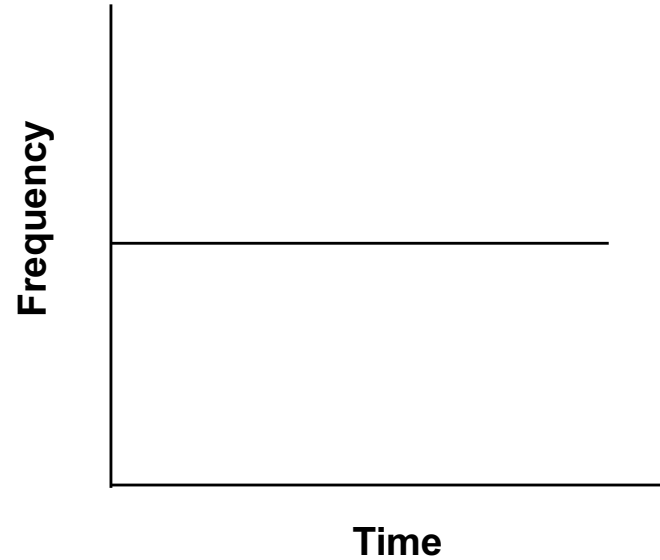
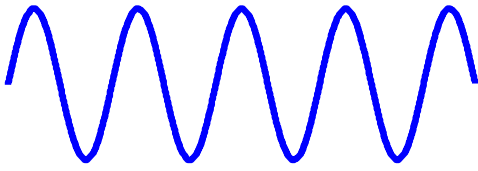

Pulse with changing frequency

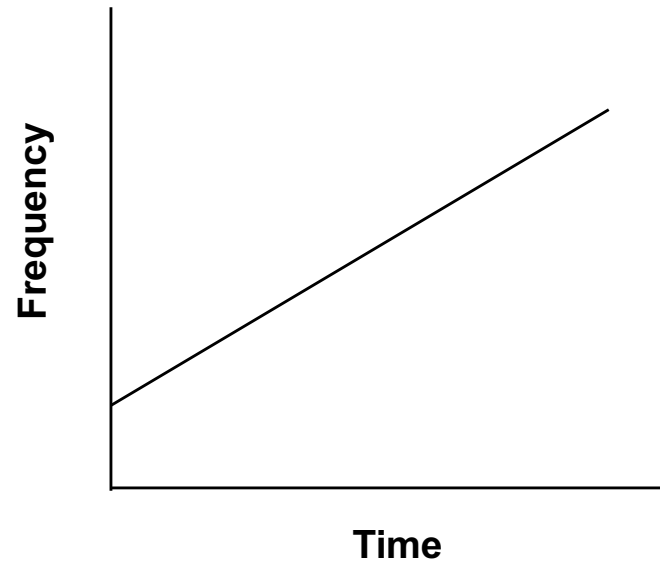
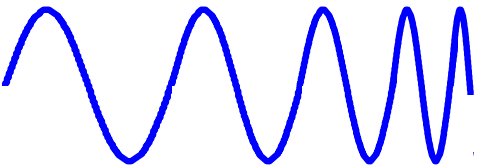

Linear
Frequency-
Modulated
(LFM)
Waveform

Radar Range Measurement

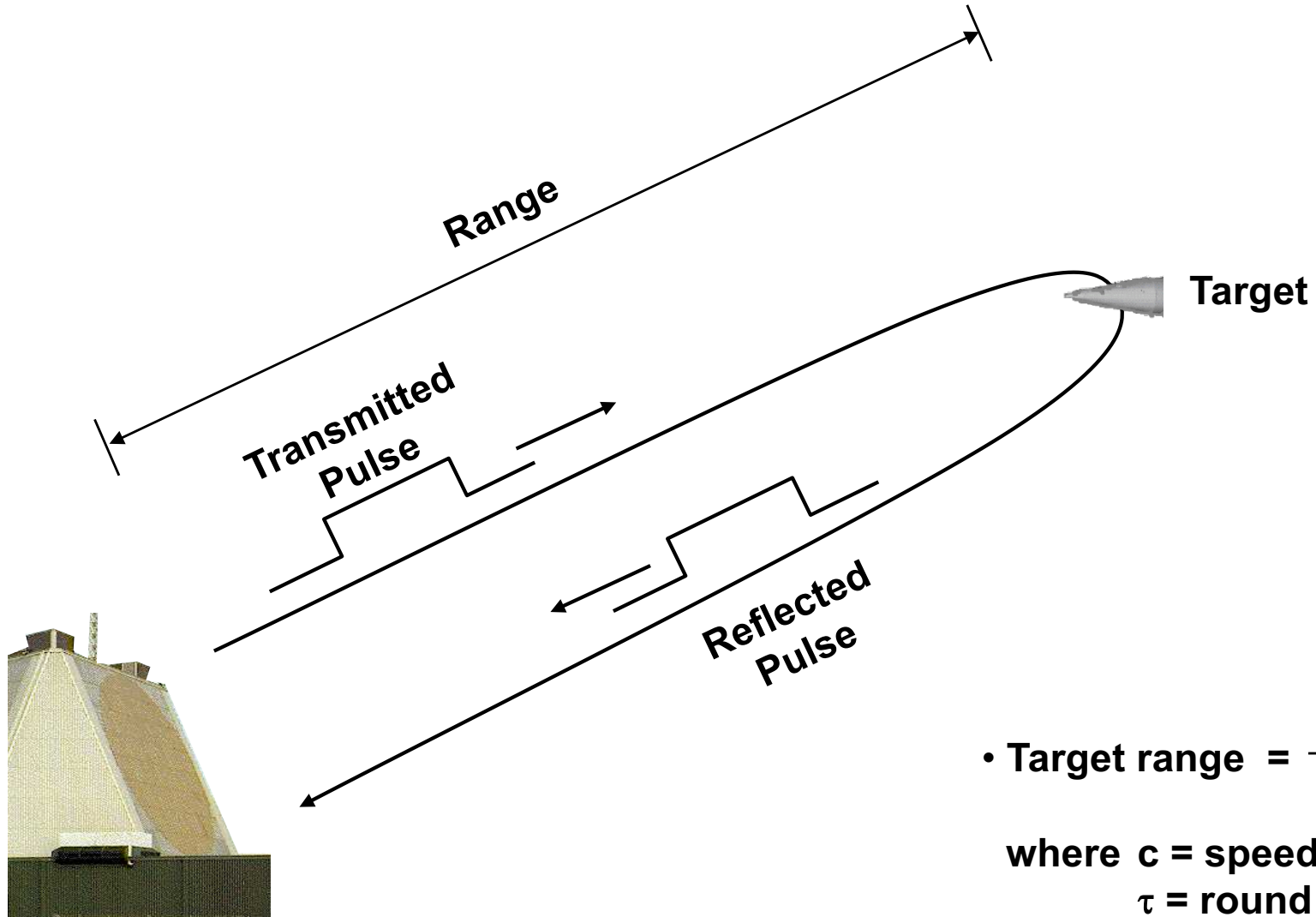

Signal Processing

Pulse Compression

Problem: Pulse can be very long; does not allow accurate range measurement

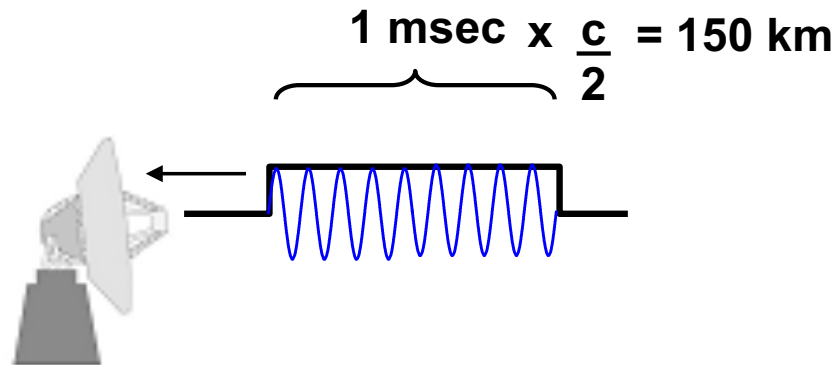

Solution: Use pulse with changing frequency and signal process using “matched filter”

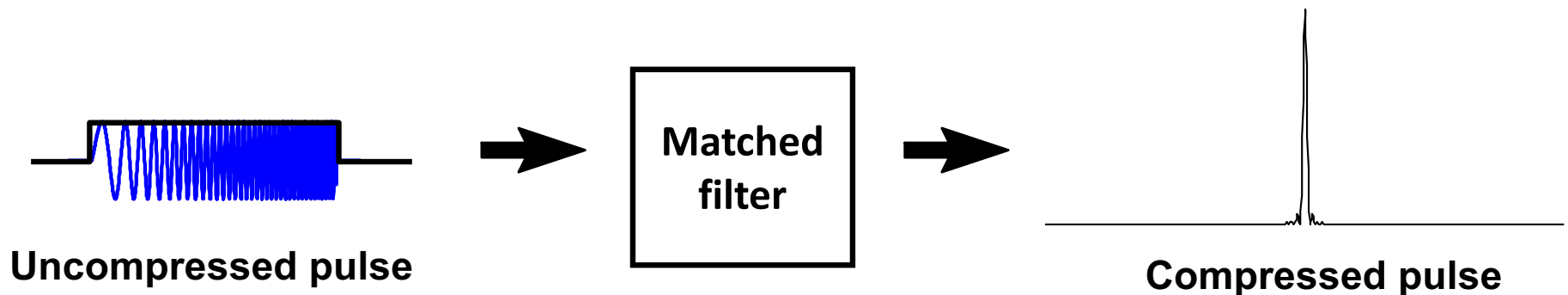

Detection of Signals in Noise

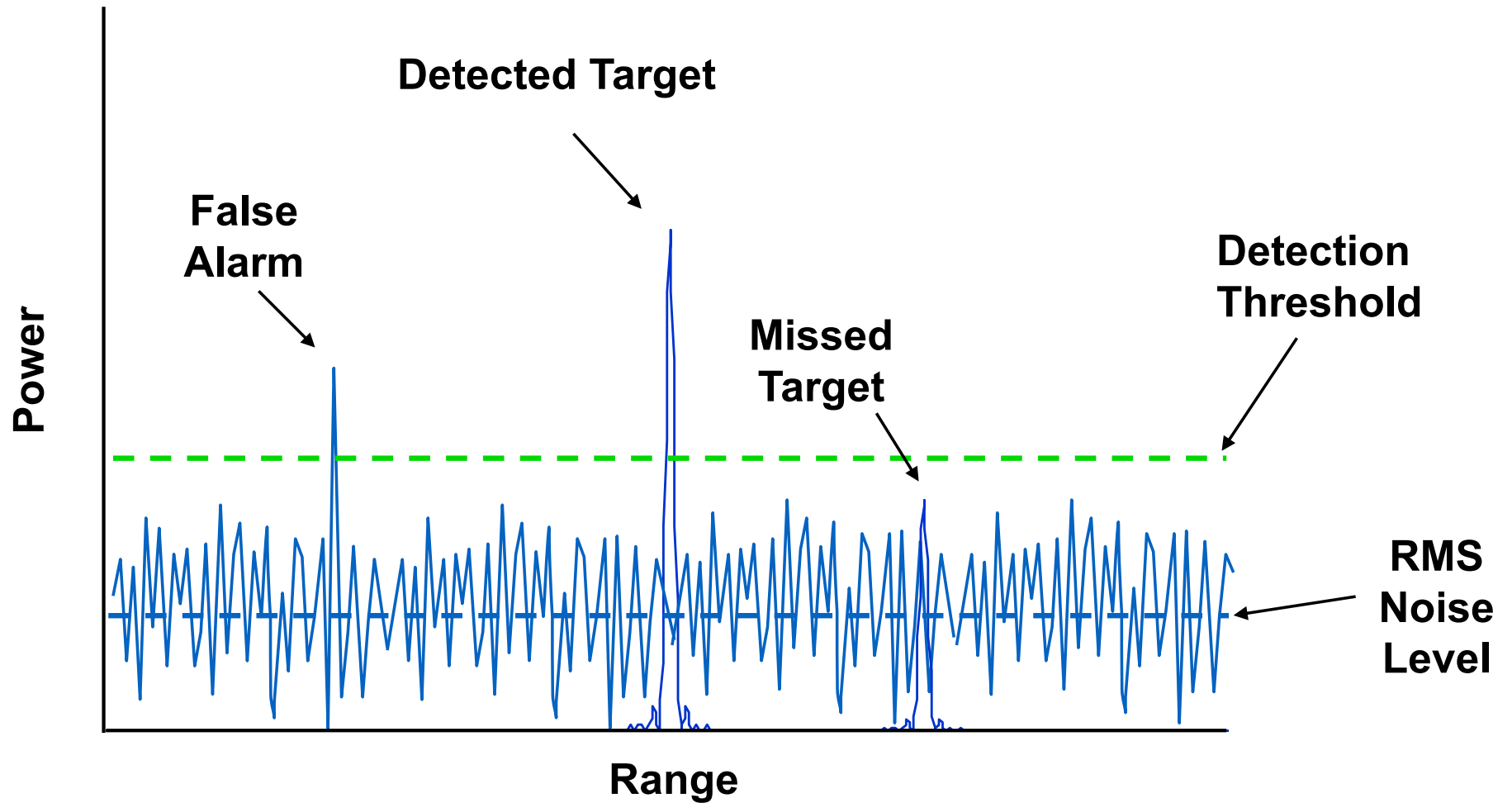

Coherent Integration

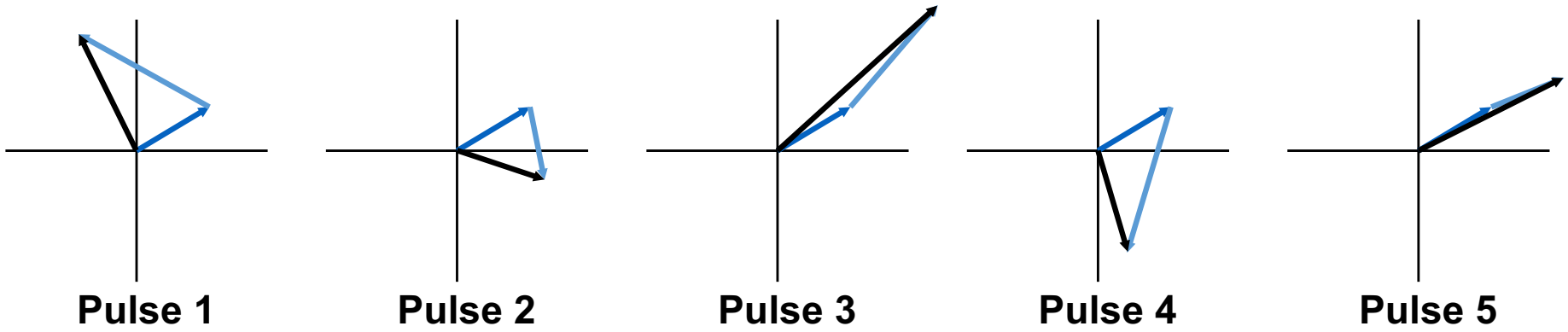

- Coherent target returns
- Noise samples at low SNR

- Resultant signal

Coherently Integrated Pulses

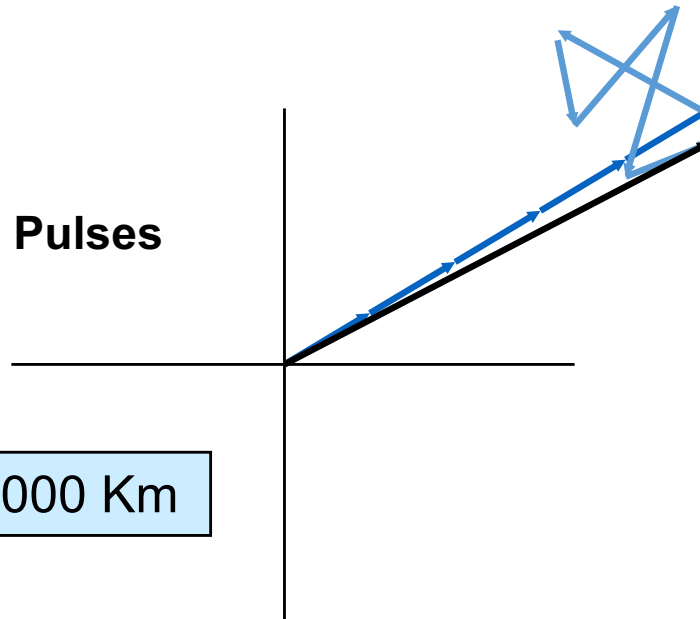

Deep space targets at 30,000 – 40,000 Km

Outline: Radar Basics

- Electromagnetic spectrum
- Radio waves and propagation
- Radar fundamentals
 - Radar equation
 - Range resolution and pulsed radars
- Doppler and Doppler Radars

Moving target: Doppler

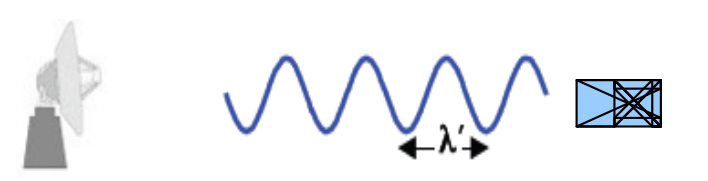
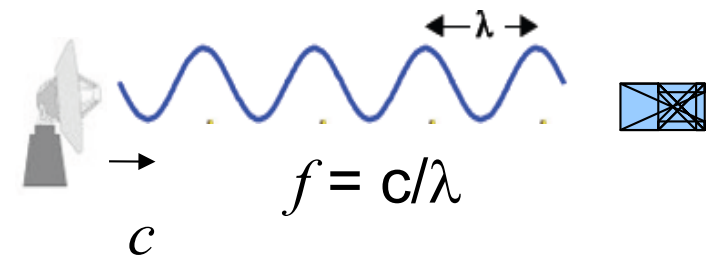
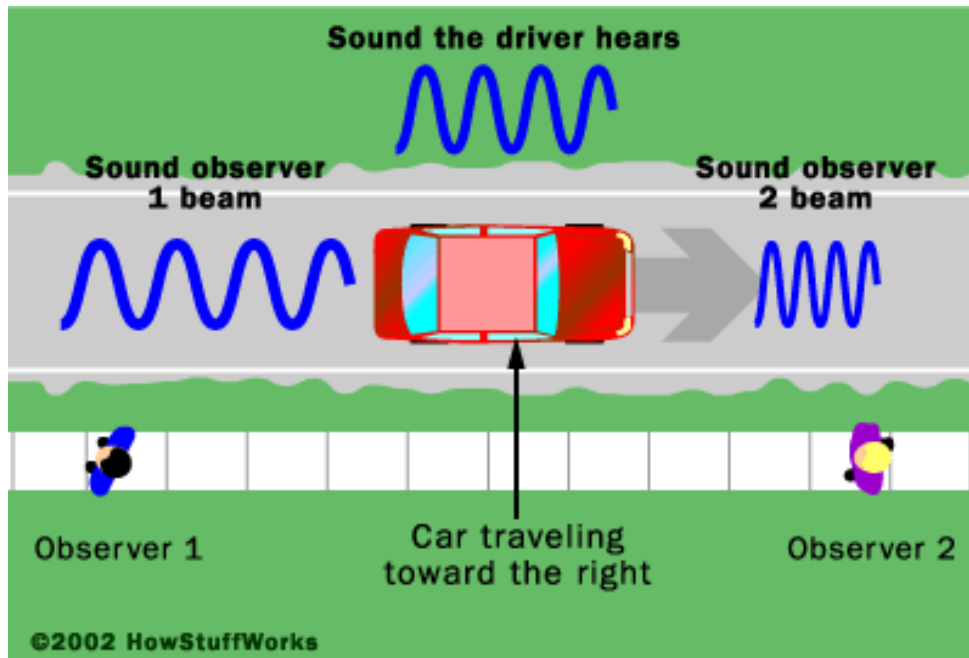

$$f' = f \pm \frac{2v}{\lambda}$$

Doppler shift

Positive Doppler = target moving **toward** the observer
Negative Doppler = target moving **away** from the observer

Sign conventions

The Doppler frequency is negative (lower frequency, red shift) for objects receding from the radar

The Doppler frequency is positive (higher frequency, blue shift) for objects approaching the radar

These “color” shift conventions are typically also used on radar displays of Doppler velocity

Red: Receding from radar

Blue: Toward radar

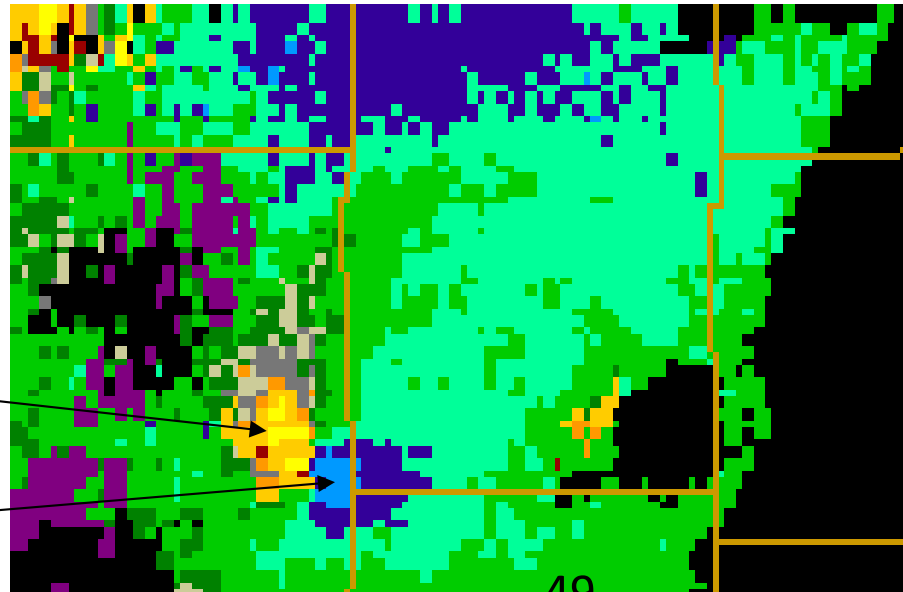

Doppler Shift Concept

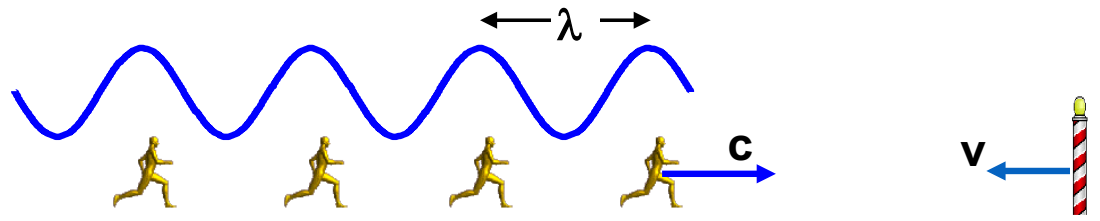

$$f = \frac{c}{\lambda}$$

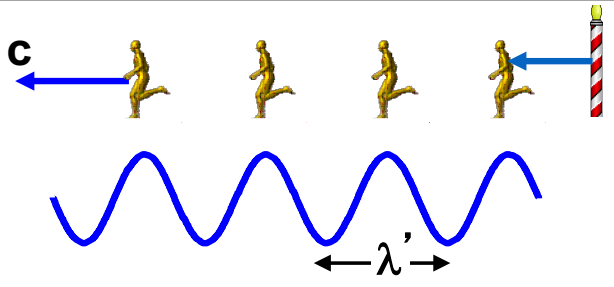
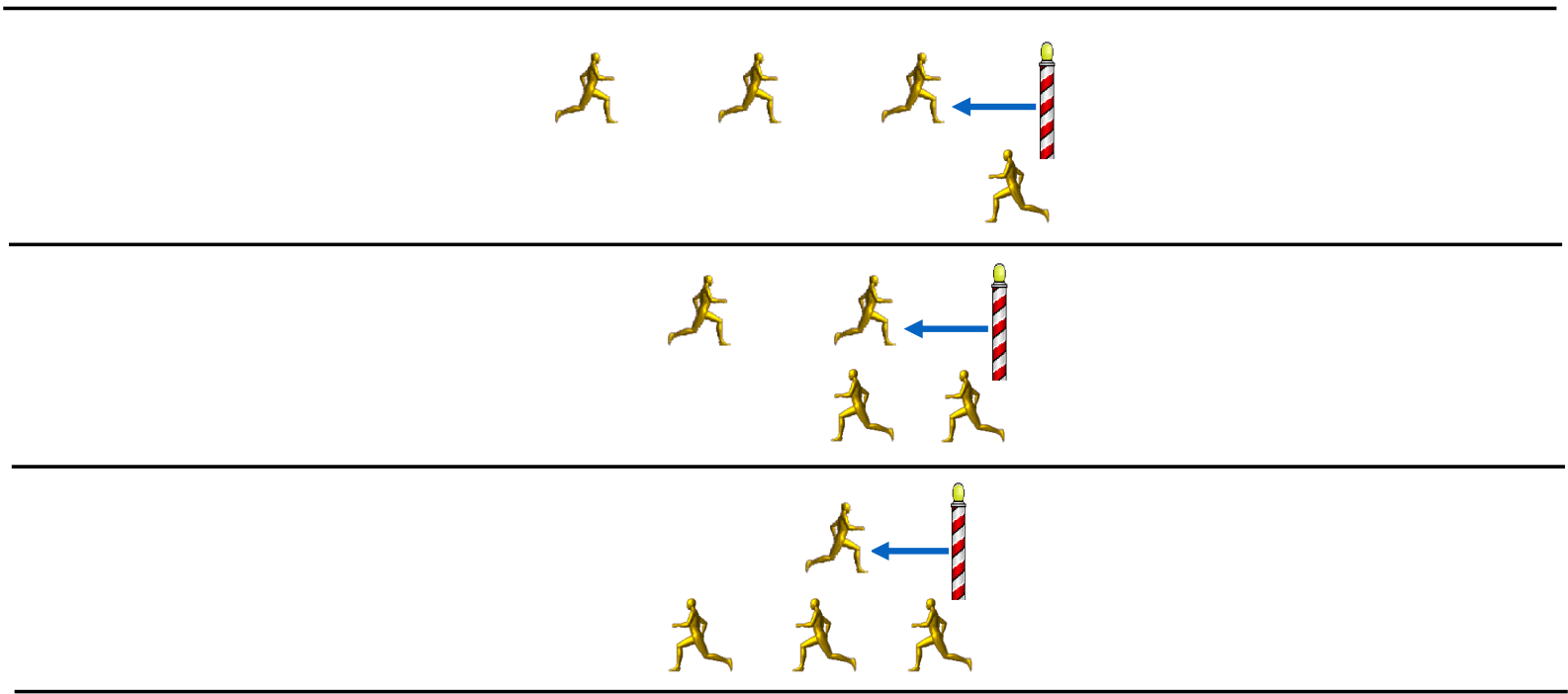

$$f' = f \pm (2v/\lambda)$$

Doppler shift

Doppler shift frequency

Tx signal: $\cos(2\pi f_o t)$

Return from a moving target: $\cos[2\pi f_o(t + 2R/c)]$

If target is moving with a constant velocity: $R = R_o + v_o t$

then,

Return: $\cos[2\pi(f_o + f_o 2v_o/c)t + 2\pi f_o R_o/c]$

↑
Doppler frequency:
 $-2f_o v_o/c = -2v_o/\lambda_o$

Pulsed Doppler Radar system

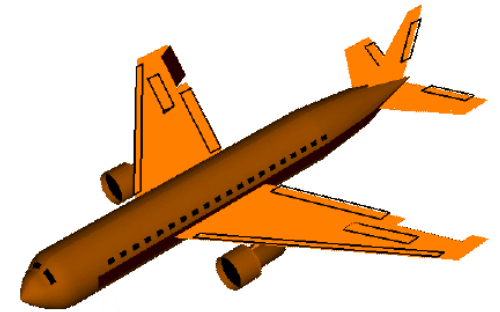
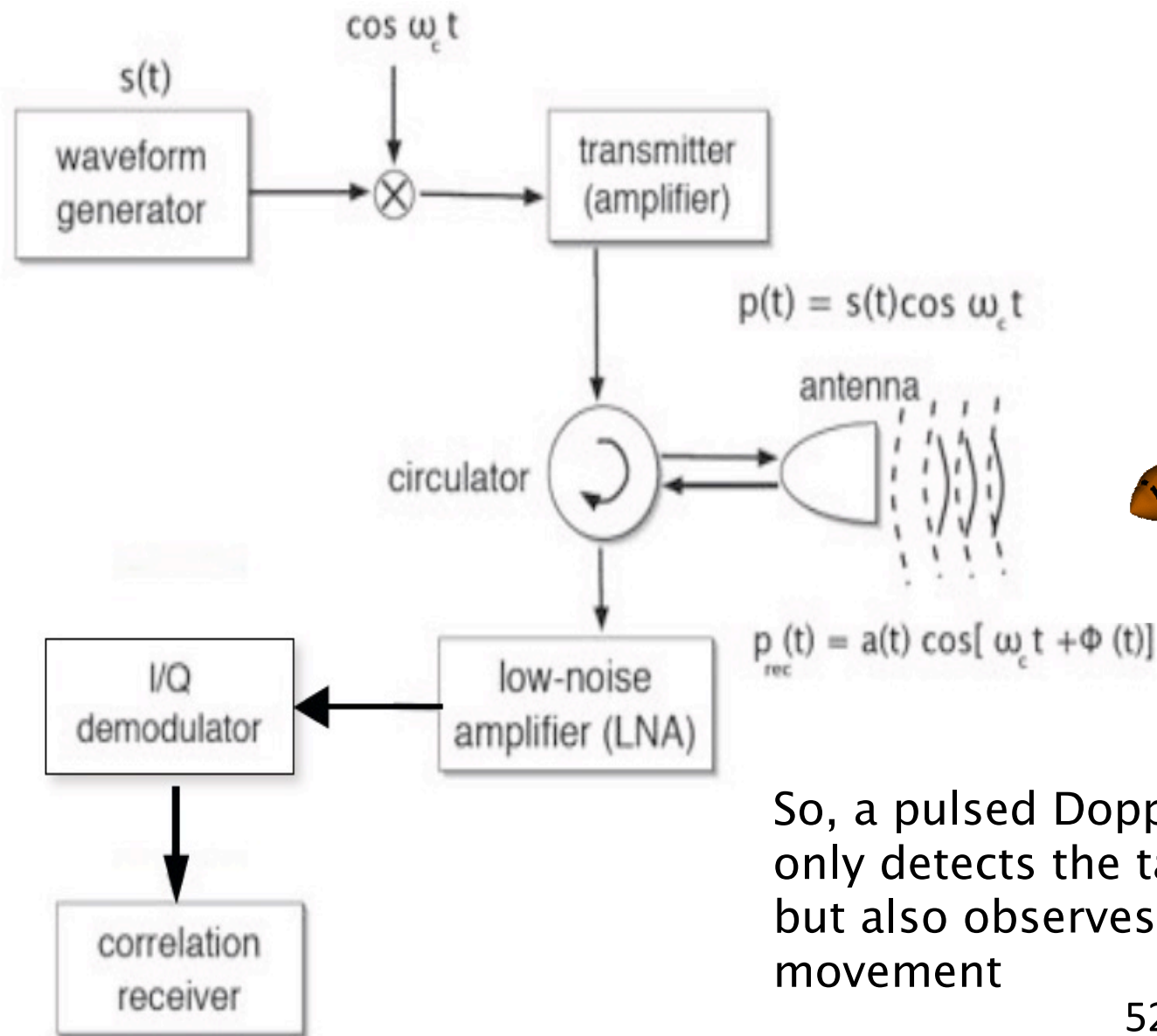

Image courtesy of NASA

So, a pulsed Doppler radar not only detects the target location, but also observes the target movement

LUNCHTIME !!!